



MTM
ELECTRIC TRAINS®

2006 READY-TO-RUN
SETS & ACCESSORIES



WHO IS M.T.H.?

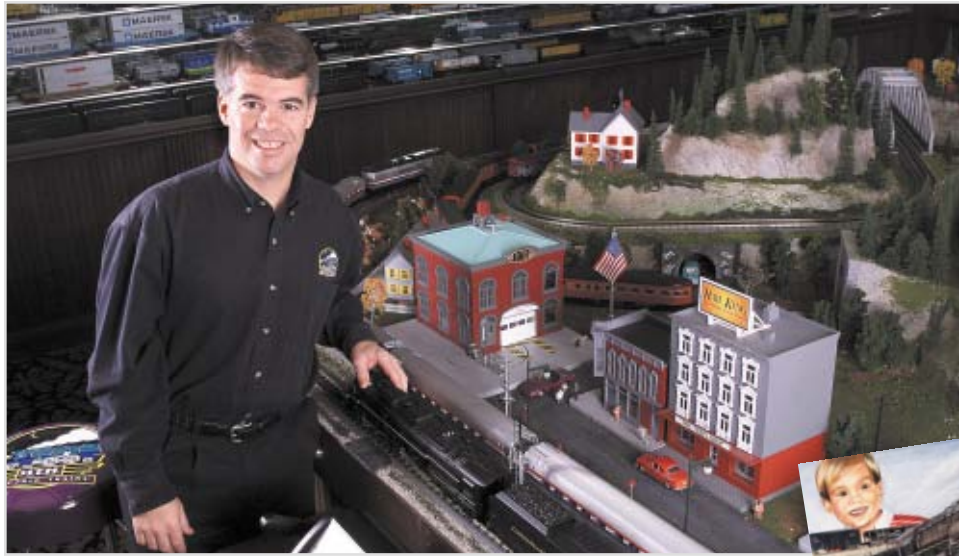

A DREAM COME TRUE

M.T.H. Electric Trains is the realization of a boyhood dream. In 1980, college student Mike Wolf, already an eight-year veteran of the model train industry, opened a mail order train business in a spare bedroom of his parents' home. Armed with a separate phone line and a fancy new device called a FAX machine, Mike processed and shipped orders, worked train shows on weekends, and worked for Williams Reproductions, a fledgling model railroad manufacturer.

Three years later, Mike's Train House, as the business was called then, made the leap into manufacturing by offering reproductions of tinplate metal trains popular in the 1920s and '30s. Sheet-metal parts were stamped in Minnesota, shipped to Maryland where they were painted by a high-school friend of Mike's



in his parents' garage, and assembled in the Wolf family's basement.

Mike's experience and expertise in manufacturing toy trains led to projects with Lionel® and other O-gauge model railroad firms, and eventually he began to devote himself to manufacturing full

time. In 1993, M.T.H. Electric Trains introduced its own O gauge product line with a scale-detailed diesel, and followed that up with dozens of realistic diesel, electric, and steam locomotives that had never been offered to the O gauge market.

RAILKING SETS FOR BEGINNERS

In 1995 the first RailKing products were introduced. Aimed at beginners and at hobbyists who prefer more traditional-sized toy trains, lower-cost, less-detailed RailKing models offer the same outstanding quality as more expensive scale-sized M.T.H. Premier engines and rolling stock. Mike Wolf has always recognized that a child's first train set represents the best hope for perpetuating our hobby, and RailKing train sets represent our commitment to making your introduction to model railroading a great experience.

COMMITMENT TO SERVICE

We think one of the true measures of a company's attitude toward its customers is how easy it is to get parts and service. Over the past five years, we've worked to build a network of service centers across the United States, with the

goal of enabling virtually any customer to walk into a local hobby shop and have MTH products serviced by a factory-trained technician.

Of course, we also maintain a fully staffed warranty repair department at our Columbia, Maryland headquarters, as well as an extensive parts inventory. We think nobody in the hobby can match our parts availability or our commitment to providing service at the hobby shop level.

In over a quarter-century of operation, Mike's Train House and M.T.H. Electric Trains have cataloged nearly 10,000 separate items. While much of our product line is made for experienced hobbyists, we also believe we make the finest entry-level O gauge train sets you can buy - because in the long run, train set customers are the future of our company. "Skimping on train set value is akin," Mike is fond of saying, "to slamming the door on a customer. By making that first experience one of quality, value, and fun, I believe we open the door to creating a model railroader for life."

M.T.H. TRAINS ARE MORE FUN

M.T.H. trains are more fun because they portray the sights and sounds that make real trains dramatic and exciting.

GREAT SMOKE

Our steam engines feature fan-driven ProtoSmoke™, the most powerful smoke system in the hobby.



VIVID ENGINE SOUNDS

Proto-Sound features digital recordings with CD-quality playback: the wail of a diesel horn; the melody of an authentic steam whistle; the bell alerting passengers to your arrival or departure; and diesel roar or steam chuff that vary automatically depending on how hard your engine is working.

STATION SOUNDS

Proto-Sound passenger engines offer Passenger Station Proto-Effects™, a complete arrival and departure sequence that you can activate from your transformer. Freight engines include Freight Yard Proto-Effects™, a symphony of freight terminal sounds.

REMOTE UNCOUPLING

Proto-Sound steam and diesel engines offer remote uncoupling anywhere on your layout, accompanied by the clank of the coupler opening and the hiss of air hoses parting.



SPEED CONTROL

Many toy trains have two speeds: fast and faster. Most M.T.H. locomotives feature Proto-Sound® 2.0, our unique sound and control system that allows our engines to throttle down to a slow crawl, highball down the main line, or maintain any speed in between. The Proto-Speed Control™ built into Proto-Sound® 2.0 acts like the cruise control on a car, keeping your train moving at the speed you select, regardless of hills and curves.

SYNCHRONIZED CHUFF AND PUFF

Like a real steam engine, M.T.H. steamers feature puffs of smoke and steam chuff sounds synchronized with the drive wheels. Better than any other toy train, an M.T.H. locomotive portrays the drama of a steam engine s-l-o-w-l-y chuffing and puffing as it pulls out of a station and gets up to speed.

ON THE COVER

1. Engine Shed (30-9030),
2. Trackside Yard Tower (30-90006),
3. 12-Piece Railroad Worker Figure Set #12 (30-11066),
4. Freight Transfer Warehouse (30-9098),
5. Grainery (30-90026),
6. PRR R-T-R Freight Set (30-4136),
7. "O" Scale Operating Block Signal (30-11005),
8. Telephone Pole Set (30-1088),
9. Anheuser-Busch Lighted Billboard (30-90107),
10. 32 Pack Vehicle Set (30-50031)



WWW.MTHTRAINS.COM

O GAUGE IS MORE FUN!

Model trains come in a variety of sizes. Smaller sizes such as HO gauge and N gauge allow hobbyists to fit a lot of highly detailed railroad into less space. But we think O gauge - the traditional size for train sets for more than half a century - is the perfect size for a child's first electric train. Judging by the rising popularity of O gauge over the past two decades, it has become the perfect size for many adults as well. Standing about twice the size of HO trains, O gauge trains are more fun because:

They stay on the track: O gauge trains hold the track better at the high speeds that children often prefer, thanks in part to the larger flanges on O gauge wheels.

They're easy to handle: The larger size of O gauge trains makes them easier for children to handle than smaller-gauge trains - and much easier to place on the track.



They're impressive: Size and weight make an O gauge train a memorable toy. M.T.H. steam engines feature die-cast metal boilers and frames, M.T.H. diesels feature die-cast trucks, and all M.T.H. products have metal

wheels and couplers. If you're looking for a toy that will make a long-term impression on a child, it's hard to beat an O gauge train.

They do things: As seen on this page and elsewhere in this catalog, O gauge offers a variety of operating, animated cars and accessories that is unmatched by any other scale or gauge.



LOAD YOUR COAL TRAIN WITH THIS **OPERATING COALING TOWER**; MORE INFO ON PAGE 48.



THIS **DRIVE-IN DINER** WITH ANIMATED CARHOPS LIGHTS UP THE NIGHT; SEE PAGE 54.

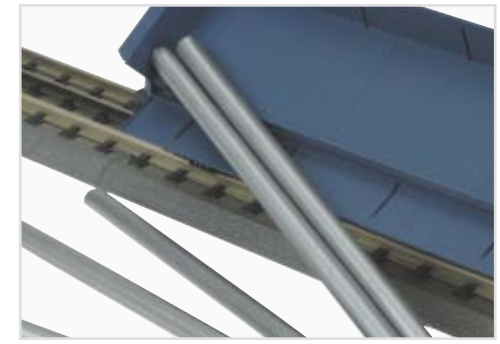

DROP OFF FREIGHT WITH THIS **OPERATING DUMP CAR**; MORE DETAILS ON PAGE 10.



THIS **OPERATING WATCHMAN** POPS OUT OF HIS SHANTY WHEN A TRAIN APPROACHES; SEE PAGE 48.



THIS **OPERATING STATION PLATFORM** CREATES THE ILLUSION THAT PASSENGERS HAVE BOARD-ED A TRAIN; SEE PAGE 49.



FILL 'ER UP AT THIS **ANIMATED GAS STATION** WITH SOUNDS; SEE DETAILS ON PAGE 54.

QUALITY AND VALUE COMPARE BEFORE YOU BUY

At M.T.H., we consider the ready-to-run train set our best opportunity to make a great impression on any newcomer to the wonderful world of model railroading. That's why we don't skimp on the quality and value you'll find in every RailKing® and Tinplate Traditions® ready-to-run starter set. Compare our sets with those from our competitors and see what makes M.T.H.'s starter sets the best way to start your model railroading journey.



EVERY RAILKING CAR AND LOCOMOTIVE FEATURES DIE-CAST METAL TRUCKS AND COUPLERS.



EVERY RAILKING READY-TO-RUN TRAIN SET INCLUDES TRACK, TRANSFORMER, INTERACTIVE DVD WITH TRACK LAYOUT SOFTWARE AND OPERATOR'S MANUAL.

Every RailKing ready-to-run set features RealTrax®, O Gauge's first and most complete line of snap-together track with built-in roadbed. Only RealTrax uses solid metal track rails instead of cheaper hollow rails that can bend if stepped on. See the complete RealTrax® line beginning on page 38.



EVERY RAILKING PASSENGER CAR HAS A DETAILED, LIGHTED INTERIOR.

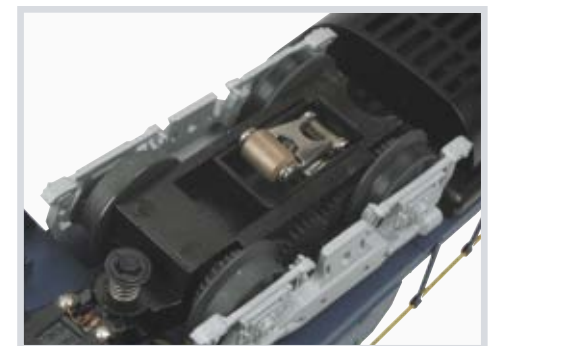

EVERY RAILKING LOCOMOTIVE FEATURES DURABLE METAL GEARS, WHEELS, AND AXLES

Every 2006 M.T.H. Train set* features a U.L. approved 100-watt or stronger transformer to ensure your set has enough power now and when you expand it with extra cars, track and accessories.

* Trolley Sets feature a 40-watt transformer

THE HIGHEST QUALITY TRAIN SETS YOU CAN BUY



EVERY RAILKING LOCOMOTIVE AND TRAIN SET IS BUILT TO THE SAME QUALITY STANDARD AS OUR TOP-OF-THE-LINE PREMIER BIG BOY



AT&SF 4-6-0 TEN WHEELER



Atchison Topeka & Santa Fe - 4-6-0 Ten Wheeler Train Set
30-4157-1 w/Proto-Sound® 2.0 \$349.95

EXPAND YOUR SET WITH EXTRA CARS



Atchison Topeka & Santa Fe - 34' Box Car - 19th Century
30-74361 \$39.95

CARS HAVE LIGHTED, DETAILED INTERIORS



Atchison Topeka & Santa Fe - 3-Car Overton Passenger Coach Set
30-6418 \$129.95



- Set Features**
- Die-Cast Steam Locomotive
 - 3-Car Freight Consist
 - 31" x 51" 12-Piece RealTrax® Oval
 - Z-1000™ Transformer With Controller
 - Lighted Track Lock-On
 - RailWare™ Interactive DVD With Track Layout Software

- Locomotive Features:**
- Die-Cast Boiler and Chassis
 - Flywheel-Equipped Motor
 - Locomotive Speed Control
 - Operating Headlight
 - Remotely Controlled Proto-Coupler™
 - Synchronized Puffing Proto-Smoke Unit
 - All-Metal Wheels and Axles
 - Proto-Sound® 2.0 Sound System Featuring Freight Yard Proto-Effects™
 - Locomotive Measures: 19 1/4" x 2 1/2" x 3 3/4"

At the turn of the 20th century, the railroad landscape was filled with large-wheeled steam locomotives with huge funnel-shaped smoke stacks. First appearing in the 1870s, these 4-6-0 steam engines were some of the railroads' most favored designs until the early 1900s. Specializing in both freight and passenger use, these magnificent engines helped America expand westward while moving thousands of passengers and hauling tons of freight.

Although long gone, the spirit of these engines can be revived with this magnificent 4-6-0 freight set that features a heavy 4-6-0 die-cast metal steam engine heading up a three-car freight consist. Decorated in colorful Atchison Topeka & Santa Fe livery, the locomotive is equipped with all-metal gears, wheels and axles to ensure a lifetime of fun.

The unique sounds of Proto-Sound 2.0 will amaze your friends and family. Imagine their faces when the whistle wails or the exclusive Freight Yard Proto-Effects simulate the loading and unloading for freight - just as if you were right there in the freight yard! Of course, seeing the synchronized puffing smoke from the locomotive as it pulls its three-car freight consist with die-cast metal trucks and operating metal couplers is even more impressive and tells all who see it that this is one great set. As with all RailKing Ready-to-Run sets, the 12-piece RealTrax oval assembles in minutes and can be placed right on the carpet or floor for a quick, temporary layout.

- Freight Cars Feature:**
- Intricately Detailed Durable ABS Bodies
 - Die-Cast 4-Wheel Trucks
 - Operating Die-Cast Metal Couplers
 - Colorful, Attractive Paint Schemes
 - Fast-Angle Wheel Sets
 - Needle-Point Axles
 - Metal Wheels and Axles
 - Each Car Measures Approximately: 13 3/4" x 2 1/2" x 3 1/2"



CHRISTMAS 4-6-0 TEN WHEELER



Christmas - 4-6-0 Ten Wheeler Train Set
30-4156-1 w/Proto-Sound® 2.0 \$349.95
30-4156-0 w/Loco-Sound™ \$279.95

Loco-Sound™ engines are equipped with transformer activated bell and whistle sounds only.



Christmas - Overton Passenger Coach
30-6417 \$44.95

EXPAND YOUR SET WITH EXTRA CARS

Christmas - Stock Car - 19th Century
30-7162 \$39.95



- Set Features:**
- Die-Cast Steam Locomotive
 - 3-Car Passenger Consist
 - 31" x 51" 12-Piece RealTrax® Oval
 - Z-1000™ Transformer With Controller
 - Lighted Track Lock-On
 - RailWare™ Interactive DVD With Track Layout Software

- Locomotive Features:**
- Die-Cast Boiler and Chassis
 - Flywheel-Equipped Motor
 - Locomotive Speed Control
 - Operating Headlight
 - Remotely Controlled Proto-Coupler™
 - Synchronized Puffing Proto-Smoke™ Unit
 - All-Metal Wheels and Gears
 - Proto-Sound® 2.0 Sound System Featuring Holiday Station Proto-Effects™
 - Loco-Sound™ engines are equipped with transformer activated bell and whistle sounds only.
 - Locomotive Measures: 19 1/4" x 2 1/2" x 3 3/4"

The Holiday season and model trains have always gone together. What better way to recreate this classic memory than to include a beautifully decorated set around your holiday tree. Featuring bright, holiday colors the Christmas 4-6-0 passenger set captures the spirit and fun of model railroading in an affordable train set that will last for years and years.

The unique sounds of Proto-Sound 2.0 will amaze your friends and family. Imagine their faces when the whistle wails or the exclusive Passenger Station Proto-Effects begin calling out Santa's next station stop on the line! Of course, seeing the synchronized puffing smoke from the locomotive as it pulls its three-car passenger consist with die-cast metal trucks and operating metal couplers is even more impressive and tells all who see it that this is one great set. As with all RailKing Ready-to-Run sets, the 12-piece RealTrax oval assembles in minutes and can be placed right on the carpet for a quick, temporary layout.

- Passenger Cars Feature:**
- Intricately Detailed Durable ABS Bodies
 - Die-Cast 4-Wheel Trucks
 - Operating Die-Cast Metal Couplers
 - Colorful, Attractive Paint Schemes
 - Metal Wheels and Axles
 - Detailed Car Interiors
 - Overhead Car Interior Lighting
 - Each Car Measures Approximately: 10 3/4" x 2 3/8" x 3 1/8"



RUDOLPH THE RED-NOSED REINDEER® 2-8-0 STEAM



**FEATURING RUDOLPH®
DIALOGUE AND MUSIC
FROM THE CLASSIC
TV SHOW!**

Rudolph The Red-Nosed Reindeer® - 2-8-0 Steam Train Set

- 30-4173-1 Proto-Sound® 2.0 \$349.95
- 30-4173-0 Loco-Sound™ \$279.95

Loco-Sound™ engines are equipped with transformer activated bell and whistle sounds only.



FIGURES ARE NOT INCLUDED

A train set is a great way to start your family's model railroading tradition and our RailKing Rudolph The Red-Nosed Reindeer® set might be your perfect choice. The locomotive is decorated in red & black colors and sports a red headlight guiding Santa's train through the countryside. This creative adaptation of a 2-8-0 Consolidation locomotive features a heavy all-metal steam engine boiler and chassis that feels as strong as it runs. The all-metal gears, wheels and axles will ensure a lifetime of fun and the unique sounds of Proto-Sound® 2.0 will amaze your friends and family.

Imagine their faces when the whistle wails or the exclusive Rudolph Proto-Effects™ begin playing sound clips from one of television's most timeless Christmas shows. Of course, seeing the synchronized puffing smoke from the locomotive as it pulls its three distinctive freight cars — each equipped with sprung die-cast metal trucks and operating metal couplers — is even more impressive and tells all who see it that this is one great set. As with all RailKing® Ready-to-Run sets, the 12-piece RealTrax® oval assembles in minutes and can be placed right on the carpet for a quick, temporary layout.

**EXPAND YOUR SET
WITH EXTRA CARS**

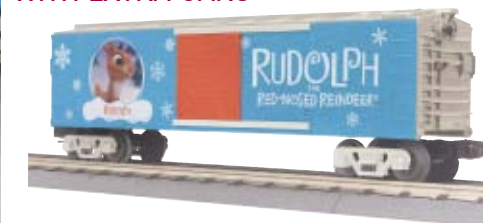

**Rudolph The Red-Nosed Reindeer® -
Box Car**
30-74359 \$44.95



**Rudolph The Red-Nosed Reindeer® -
Yukon Cornelius™ Box Car**
30-74360 \$44.95



**Rudolph The Red-Nosed Reindeer® -
4-Bay Cylindrical Hopper Car**
30-75220 \$44.95

LAYOUT BUILDERS

Expand your train set with Layout Builder track packages.

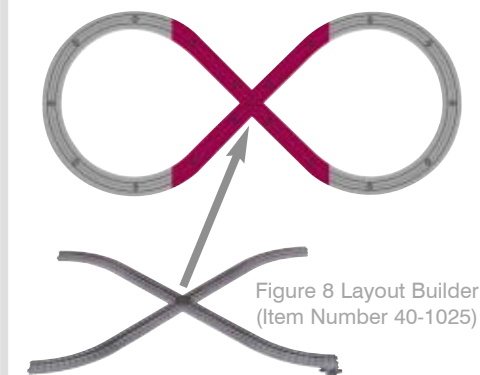
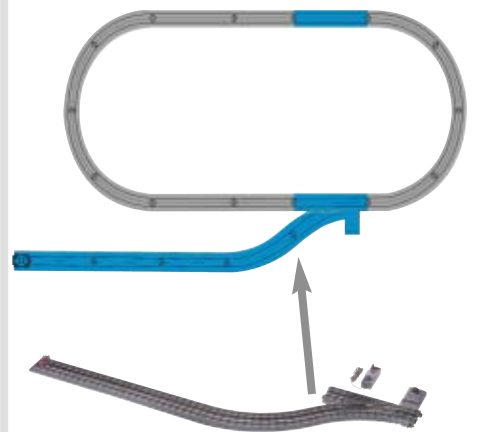

Figure 8 Layout Builder (Item Number 40-1025)

Figure 8 Layout Builder Contains: (4) O-31 Curves, (4) 10" Straights, (1) Lighted Lockon, (1) 90 Degree Crossover



Left Hand Track Siding Layout Builder (Item Number 40-1026)

Right Hand Track Siding Layout Builder also available (Item Number 40-1027)

Track Siding Layout Builder Sets Contain: (1) Left-Hand OR Right Hand O-31 Switch, (4) 10" Straights, (1) O-31 Curve, Remote Control, (1) RealTrax Bumper

- Set Features:**
- Die-Cast Steam Locomotive
 - 3-Car Freight Consist
 - RailWare™ Interactive DVD With Track Layout Software
 - 31" x 51" 12-Piece RealTrax Oval
 - Z-1000™ Transformer With Controller
 - Lighted Track Lock-On

- Proto-Sound® 2.0 Locomotive Features:**
- Die-Cast Boiler and Chassis
 - Flywheel-Equipped Motor
 - Locomotive Speed Control
 - Remotely Controlled Proto-Coupler™
 - Operating Red Headlight
 - Synchronized Puffing ProtoSmoke™ Unit
 - All-Metal Wheels and Gears
 - Proto-Sound® 2.0 Sound System Featuring Proto-Effects™
 - Locomotive Measures: 19 1/4" x 2 1/2" x 3 3/4"

- Freight Cars Feature:**
- Intricately Detailed Durable ABS Bodies
 - Die-Cast 4-Wheel Trucks
 - Operating Die-Cast Metal Couplers
 - Colorful, Attractive Paint Schemes
 - Metal Wheels and Axles
 - Sliding Car Doors
 - Freight Cars Measure: 10 3/4" x 2 3/8" x 3 1/8"



Rudolph the Red-Nosed Reindeer © and © The Rudolph Company, L.P. "Rudolph the Red-Nosed Reindeer" animated program © Classic Media, Inc. All Rights Reserved.

CHRISTMAS ACCESSORIES



AUTOMATIC BUMP-REVERSE

While our trolley sets come with a circle of track, their bump-reverse feature allows continuous point-to-point operation as well. The trolley automatically reverses direction each time it hits a bumper.

(For additional RealTrax and lighted bumpers, see pages 38-41.)

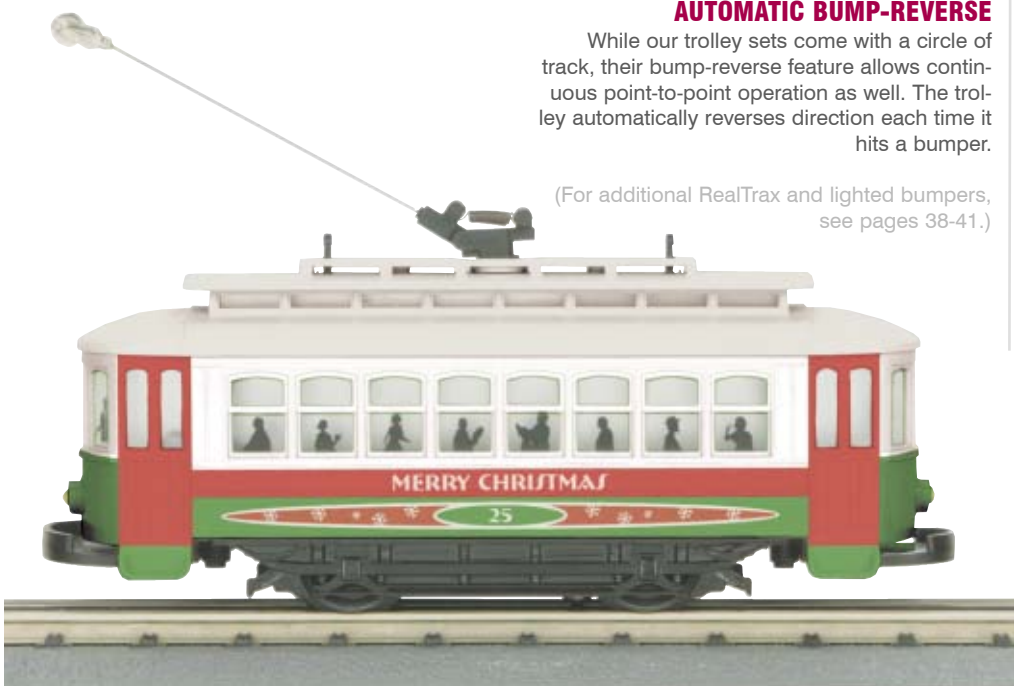

Christmas - Trolley R-T-R Train Set
30-4172-1 \$119.95

Christmas - Bump-n-Go Trolley
30-2583 \$59.95

Introduce someone you love to model railroading with the magic of a RailKing® Ready-To-Run trolley set, or take advantage of the way it complements your holiday decor when set up around the Christmas tree.

The colorful trolley features a lighted interior, metal wheels and gears, and a long-lasting motor. The unit operates on any O Gauge track system including the easy-to-assemble RealTrax system found inside each set. Optional track bumpers can be added to take advantage of the Automatic Bumper Reversing Mechanism (ABRM) that changes the trolley's direction each time it hits a track bumper.

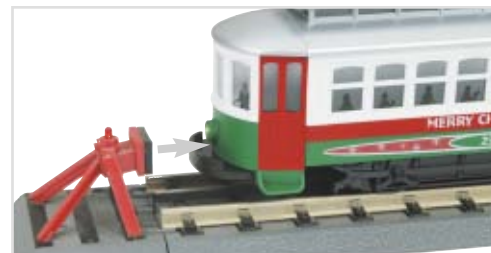

- Trolley Set Features:
- Operating Trolley Car
 - RailWare™ Interactive DVD With Track Layout Software
 - 31" diameter 8-Piece RealTrax circle
 - ZDC Transformer With Controller
 - Lighted Track Lock-On

- Trolley Features:
- Detailed ABS Body
 - Powerful Motor
 - Automatic Reversing Bumpers
 - Operating Headlights
 - Moveable Power Pole
 - Lighted Interior
 - All-Metal Wheels and Gears
 - Measures: 8 1/4" x 2 3/8" x 3 1/3"
 - Operates On O-27 Curves



RailKing operating freight cars add a new dimension and excitement level to your O Gauge layout with realistic action and quiet, smooth operation.

Like most M.T.H. operating cars, the Signaling Santa car comes to life when parked on an operating track section. When the track section is activated, the car door slowly slides backward followed by Santa Claus himself leaning out of the car with his lighted signal lantern aglow.

You can see many of the M.T.H. operating cars in action the next time you visit the M.T.H. website (www.mthtrains.com). Just click on the Video Link located right on the home page.



Christmas - Operating Box Car w/Signaling Santa
30-79141 \$59.95

DOOR OPENS BY REMOTE CONTROL AND SIGNALING SANTA POPS OUT, WAVING LIGHTED LANTERN.

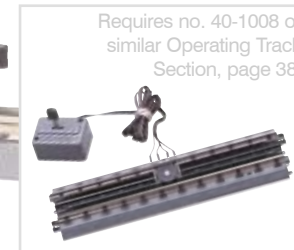

Requires no. 40-1008 or similar Operating Track Section, page 38.



Christmas - Box Car
30-74357 \$39.95



Happy Holidays - Box Car
30-74356 \$39.95



Christmas - Flat Car w/Christmas Trees
30-76211 \$39.95



Christmas - Flat Car w/Fire Truck
30-76212 \$49.95

- Freight Car Features:
- Intricately Detailed Durable ABS Body
 - Metal Wheels and Axles
 - Die-Cast 4-Wheel Trucks
 - Operating Die-Cast Metal Couplers
 - Colorful, Attractive Paint Schemes
 - Decorative Brake Wheels
 - Unit Measures: 11 1/2" x 2 3/8" x 2 5/16"
 - Operates On O-27 Curves





ANHEUSER-BUSCH 2-8-0 STEAM



Anheuser-Busch - 2-8-0 Steam Train Set
30-4155-1 w/Proto-Sound® 2.0 \$349.95



Who says model trains are just for kids? This beautifully decorated "adult collectible" train set is a great way to begin your own model railroading tradition and comes fully equipped with a load of features that are sure to entertain. Decorated in black & red Anheuser-Busch livery, this creative adaptation of the 2-8-0 locomotive features a heavy all-metal steam engine boiler and chassis that feels as strong as it runs. The all-metal gears, wheels and axles will ensure a lifetime of fun and the unique sounds of Proto-Sound® 2.0 will amaze your friends and family.

Imagine their faces when the whistle wails or the exclusive Anheuser-Busch Proto-Effects™ begin playing the classic Budweiser theme song. Of course, seeing the synchronized puffing smoke form the locomotive as it pulls its three distinctive freight cars — each outfitted with sprung die-cast metal trucks and operating metal couplers — is even more impressive and tells all who see it that this is one great set. As with all RailKing® Ready-to-Run sets, the 12-piece RealTrax® oval assembles in minutes and can be placed right on the carpet or floor for a quick, temporary layout.

© 2006 Anheuser-Busch, Inc. All Rights Reserved.

EXPAND YOUR SET WITH EXTRA CARS



Anheuser-Busch - Modern Reefer Car
30-78022 \$44.95



Anheuser-Busch - Modern Reefer Car
30-78023 \$44.95

- Set Features:**
- Die-Cast Steam Locomotive
 - 3-Car Freight Consist
 - RailWare™ Interactive DVD With Track Layout Software
 - 31" x 51" 12-Piece RealTrax® Oval
 - Z-1000™ Transformer With Controller
 - Lighted Track Lock-On

- Locomotive Features:**
- Die-Cast Boiler and Chassis
 - Flywheel-Equipped Motor
 - Locomotive Speed Control
 - Remotely Controlled Proto-Coupler™
 - Operating Headlight
 - Synchronized Puffing ProtoSmoke™ Unit
 - All-Metal Wheels and Axles
 - Proto-Sound® 2.0 Sound System Featuring Freight Yard Proto-Effects™
 - Locomotive Measures: 19 1/4" x 2 1/2" x 3 3/4"

- Freight Cars Feature:**
- Intricately Detailed Durable ABS Bodies
 - Die-Cast 4-Wheel Trucks
 - Operating Die-Cast Metal Couplers
 - Colorful, Attractive Paint Schemes
 - Fast-Angle Wheel Sets
 - Needle-Point Axles
 - Metal Wheels and Axles
 - Freight Car Measure: 10 3/4" x 2 3/8" x 3 1/8"

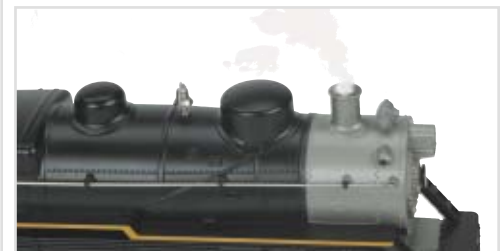

HARLEY-DAVIDSON® 2-8-0 STEAM



Harley-Davidson® - 2-8-0 Steam Train Set
30-4149-1 w/Proto-Sound® 2.0 \$349.95



A classic freight set is a great way to start your family's model railroading tradition and the Harley-Davidson® 2-8-0 Consolidation set makes a great beginning. Decorated in classic Harley-Davidson® colors, this creative adaptation of the 2-8-0 features a heavy all-metal steam engine boiler and chassis that feels as strong as it runs. The all-metal gears, wheels and axles will ensure a lifetime of fun and the unique sounds of Proto-Sound® 2.0 will amaze your friends and family.

Imagine their faces when the whistle wails or the exclusive Freight Yard Proto-Effects™ begin playing the classic sounds of Harley-Davidson® motorcycles loading up at the factory! Of course, seeing the synchronized puffing smoke from the locomotive as it pulls its three distinctive freight cars with sprung die-cast metal trucks and operating metal couplers is even more impressive and tells all who see it that this is one great set. As with all RailKing® Ready-to-Run sets, the 12-piece RealTrax oval assemblies in minutes and can be placed right on the carpet or floor for a quick, temporary layout.

EXPAND YOUR SET WITH EXTRA CARS



Harley-Davidson® - Flat Car w/ Billboard
30-76208 \$39.95

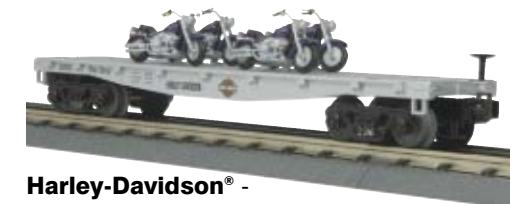

Harley-Davidson® - Flat Car w/(4) Fat Boy® Motorcycles
30-76207 \$49.95



Harley-Davidson® - Rounded Roof Box Car w/Generator
30-74353 \$44.95



Harley-Davidson® - Christmas Box Car
30-74355 \$44.95

- Set Features:**
- Die-Cast Steam Locomotive
 - 3-Car Freight Consist
 - RailWare™ Interactive DVD With Track Layout Software
 - 31" x 51" 12-Piece RealTrax® Oval
 - Z-1000™ Transformer With Controller
 - Lighted Track Lock-On

- Locomotive Features:**
- Die-Cast Boiler and Chassis
 - Flywheel-Equipped Motor
 - Locomotive Speed Control
 - Remotely Controlled Proto-Coupler™
 - Operating Headlight
 - Synchronized Puffing ProtoSmoke™ Unit
 - All-Metal Wheels and Gears
 - Proto-Sound® 2.0 Sound System Featuring Freight Yard Proto-Effects™
 - Locomotive Measures: 19 1/4" x 2 1/2" x 3 3/4"

- Freight Cars Feature:**
- Intricately Detailed Durable ABS Bodies
 - Die-Cast 4-Wheel Trucks
 - Operating Die-Cast Metal Couplers
 - Colorful, Attractive Paint Schemes
 - Fast-Angle Wheel Sets
 - Needle-Point Axles
 - Metal Wheels and Axles
 - Sliding Car Doors (boxcars only)
 - Freight Cars Measure: 10 3/4" x 2 3/8" x 3 1/8"



© 2006 H-D. All Rights Reserved. Manufactured by M.T.H. Electric Trains under license from Harley-Davidson Motor Company.
© 2006 M.T.H. Electric Trains, 7020 Columbia Gateway Drive, Columbia, Maryland 21046



ALASKA SW-1500 DIESEL

Alaska - SW-1500 Diesel Train Set
30-4158-1 w/Proto-Sound® 2.0 \$329.95

EXPAND YOUR SET WITH EXTRA CARS



Alaska - Heavy Duty Snowplow
30-79140 \$44.95



Alaska - Stock Car
30-7161 \$39.95



Alaska - Operating Dump Car w/Pipe Load
30-79137 \$49.95



- Set Features:**
- Two-Motored Diesel Locomotive
 - 3-Car Freight Consist
 - 31" x 51" 12-Piece RealTrax® Oval
 - RailWare™ Interactive DVD With Track Layout Software
 - Lighted Track Lock-On
 - 100-watt Z-1000™ Transformer

- Locomotive Features:**
- Durable ABS Body and Metal Chassis
 - (2) Flywheel-Equipped Motors
 - Locomotive Speed Control
 - Electronic Reverse Unit
 - (2) Remotely Controlled Proto-Couplers™
 - Operating Headlight
 - All-Metal Wheels and Gears
 - Proto-Sound® 2.0 Sound System Featuring Freight Yard Proto-Effects™
 - Locomotive Measures: 12 3/8" x 2 1/2" x 3 7/8"

Created by an act of Congress in 1914, the Alaska Railroad was owned and operated by the U.S. government until 1985, when the State of Alaska became the railroad's new owner. The railroad helped develop the state's economy and played a strategic role in World War II. It continues to thrive today, carrying lumber and petroleum products out of the Alaskan wilderness to the state's southern ports, and giving tourists - more than a half-million of them a year - great views of Alaska's majestic beauty.

Recreate the excitement of this wilderness railroad with this hard-working M.T.H. diesel set featuring three colorful, highly-detailed cars. With its twin flywheel-equipped motors and rubber traction tires, the Alaska Railroad SW-1500 diesel is ready for the heaviest trains on your railroad. For even more fun, add a heavy-duty snowplow in front of the engine or an operating dump car behind it. As with all Proto-Sound 2.0 locomotives, the Alaska RR diesel offers amazing slow speed capability, Proto-Speed cruise control at all speeds from a crawl to full throttle, and a wide range of dramatic railroad sounds.

- Freight Car Features:**
- Intricately Detailed Durable ABS Bodies
 - Die-Cast 4 or 6-Wheel Trucks
 - Operating Die-Cast Metal Couplers
 - Colorful, Attractive Paint Schemes
 - Fast-Angle Wheel Sets
 - Needle-Point Axles
 - Metal Wheels and Axles
 - Freight Cars Measure: 10 3/4" x 2 3/8" x 3 1/8"



MON VALLEY WORKS SW-1500 DIESEL

Mon Valley Works - SW-1500 Diesel Train Set
30-4159-1 w/Proto-Sound® 2.0 \$329.95

EXPAND YOUR SET WITH EXTRA CARS



Mon Valley Works - 3-Dome Tank Car
30-73195 \$42.95



Mon Valley Works - Slag Car
30-79142 \$44.95



Mon Valley Works - Operating Dump Car w/Pipe Load
30-79138 \$49.95

Dump logs, coal, or other cargos by remote control with these operating dump cars. Hidden motor slowly raises the bay and dumps its load at your command, shaking the car to make sure the entire load is released. A perfect companion for the Operating Coaling Tower (page 48)!

(Requires remote control track section for activation, such as no. 40-1008 RealTrax operating track, page 38)



- Set Features:**
- Two-Motored Diesel Locomotive
 - 3-Car Freight Consist
 - 31" x 51" 12-Piece RealTrax® Oval
 - RailWare™ Interactive DVD With Track Layout Software
 - Lighted Track Lock-On
 - 100-watt Z-1000™ Transformer

- Locomotive Features:**
- Durable ABS Body and Metal Chassis
 - (2) Flywheel-Equipped Motors
 - Locomotive Speed Control
 - Electronic Reverse Unit
 - (2) Remotely Controlled Proto-Couplers™
 - Operating Headlight
 - All-Metal Wheels and Gears
 - Proto-Sound® 2.0 Sound System Featuring Freight Yard Proto-Effects™
 - Locomotive Measures: 12 3/8" x 2 1/2" x 3 7/8"

- Freight Cars Feature:**
- Intricately Detailed Durable ABS Bodies
 - Die-Cast 4 Wheel Trucks
 - Operating Die-Cast Metal Couplers
 - Colorful, Attractive Paint Schemes
 - Fast-Angle Wheel Sets
 - Needle-Point Axles
 - Metal Wheels and Axles
 - Freight Cars Measure Aprox.: 10 3/4" x 2 3/8" x 3 1/8"

The three facilities of U.S. Steel's Mon Valley Works create sheet steel for everything from cars to refrigerators to metal buildings. Mon Valley trains carrying molten metal serve the blast furnaces of the Edgar Thomson Plant, located southeast of Pittsburgh. Steel slabs from Edgar Thomson are sent by rail to the nearby Irvin Plant where they are rolled into sheet products of all types, and to the Fairless Plant outside Philadelphia that produces galvanized sheets.

Bring the excitement of heavy industry to your railroad with this hard-working train that celebrates America's industrial heritage. With its twin flywheel-equipped motors and rubber traction tires, the Mon Valley Works SW-1500 diesel is ready for the heaviest loads of molten or finished steel. For even more fun, add a slag car to serve blast furnaces or an operating dump car for coal or steel pipe. As with all Proto-Sound 2.0 locomotives, the Mon Valley diesel offers amazing slow speed capability, Proto-Speed cruise control at all speeds from a crawl to full throttle, and a wide range of dramatic railroad sounds.



SANTA FE F-3 DIESEL



Santa Fe - F-3 Diesel Passenger Train Set
30-4142-1 w/Proto-Sound® 2.0 \$329.95

EXPAND YOUR SET WITH EXTRA CARS

Put your railroad to work with this classic Santa Fe Ready-To-Run diesel passenger set. Bearing the markings of one of America's most famous railroads, this set makes a great beginning for any family's first model train.

The Santa Fe F-3 diesel's classic warbonnet livery houses the locomotive's powerful 2-motored chassis. Outfitted with all-metal wheels and gears, the engine runs as good as it looks and comes equipped with digital sound and revolutionary speed control features found only in RailKing Ready-to-Run train sets. Included are three well detailed brightly painted passenger cars, each outfitted with a detailed, lighted interior and all-metal trucks, operating couplers, and metal wheels and axles ensuring years of fun operation.

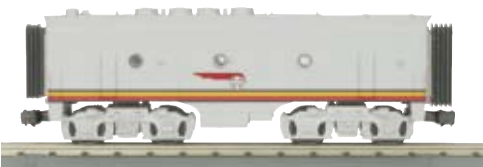

Santa Fe - F-3 B Unit - Non-Powered
33-2017-4 \$69.95



Santa Fe - F-3 A Unit - Non-Powered
33-2017-3 \$79.95



Santa Fe - O-27 Streamlined Full-Length Vista Dome Car
33-6024 \$39.95



Santa Fe - O-27 Streamlined Coach Car
33-6023 \$39.95



- Set Features:**
- Two-Motored Diesel Locomotive
 - 31" x 51" 12-Piece RealTrax® Oval
 - 3-Car Passenger Consist
 - RailWare™ Interactive DVD With Track Layout Software
 - Z-1000™ Transformer With Controller
 - Lighted Track Lock-On
 - Quick Start Video

- Locomotive Features:**
- Durable ABS Body and Metal Chassis
 - (2) Flywheel-Equipped Motors
 - Locomotive Speed Control
 - Electronic Reverse Unit
 - (2) Remotely Controlled Proto-Couplers™
 - Operating Headlight
 - All-Metal Wheels and Gears
 - Proto-Sound® 2.0 Sound System Featuring Passenger Station Proto-Effects™
 - Locomotive Measures: 11 1/2" x 2 3/8" x 3 1/2"

- Passenger Cars Feature:**
- Die-Cast 4-Wheel Trucks
 - Operating Die-Cast Metal Couplers
 - Colorful, Attractive Paint Schemes
 - Detailed Car Interiors
 - Operating Overhead Lighting
 - End-of-Car Diaphragms
 - Fast-Angle Wheel Sets
 - Needle-Point Axles
 - Metal Wheels and Axles
 - Passenger Cars Measure: 13 9/16" x 2 5/16" x 3 3/8"



PENNSYLVANIA 2-8-0 STEAM

Pennsylvania - 2-8-0 Steam Train Set
30-4136-1 w/Proto-Sound® 2.0 \$329.95
30-4136-0 w/Loco-Sound™ \$249.95

Loco-Sound™ engines are equipped with transformer activated bell and whistle sounds only.

Pennsylvania - 3-Dome Tank Car
30-73194 \$42.95



EXPAND YOUR SET WITH EXTRA CARS



Pennsylvania - Stock Car
30-7160 \$39.95

A classic freight set is a great way to start your family's model railroading tradition and the Pennsylvania 2-8-0 Consolidation set makes a great beginning. Decorated in near-black Pennsylvania Brunswick Green, this creative adaptation of the 2-8-0 features a heavy all-metal steam engine boiler and chassis that feels as strong as it runs. The all-metal gears, wheels and axles will ensure a lifetime of fun and the unique sounds of Proto-Sound 2.0 will amaze your friends and family.

Imagine their faces when the whistle wails or the exclusive Freight Yard Proto-Effects begin playing the sounds of a busy freight yard. Of course, seeing the synchronized puffing smoke from the locomotive as it pulls its three distinctive freight cars with sprung die-cast metal trucks and operating metal couplers is even more impressive and tells all who see it that this is one great set. As with all RailKing Ready-to-Run sets, the 12-piece RealTrax oval assembles in minutes and can be placed right on the carpet or floor for a quick, temporary layout.



- Set Features:**
- Die-Cast Steam Locomotive
 - 3-Car Freight Consist
 - RailWare™ Interactive DVD With Track Layout Software
 - 31" x 51" 12-Piece RealTrax® Oval
 - Z-1000™ Transformer With Controller
 - Lighted Track Lock-On

- Locomotive Features:**
- Die-Cast Boiler and Chassis
 - Flywheel-Equipped Motor
 - Locomotive Speed Control
 - Remotely Controlled Proto-Coupler™
 - Operating Headlight
 - Synchronized Puffing ProtoSmoke™ Unit
 - All-Metal Wheels and Gears
 - Proto-Sound® 2.0 Sound System Featuring Freight Yard Proto-Effects™
 - Locomotive Measures: 19 1/4" x 2 1/2" x 3 3/4"

- Freight Cars Feature:**
- Intricately Detailed Durable ABS Bodies
 - Die-Cast 4-Wheel Trucks
 - Operating Die-Cast Metal Couplers
 - Colorful, Attractive Paint Schemes
 - Fast-Angle Wheel Sets
 - Needle-Point Axles
 - Metal Wheels and Axles
 - Sliding Car Doors
 - Freight Cars Measure Approx.: 10 3/4" x 2 3/8" x 3 1/8"



B & O 2-8-0 STEAM



Baltimore & Ohio - 2-8-0 Steam Passenger Train Set
30-4150-1 w/Proto-Sound® 2.0 \$349.95

EXPAND YOUR SET WITH EXTRA CARS



Baltimore & Ohio - O-27 Madison Coach Car
33-6213 \$44.95



Baltimore & Ohio - O-27 Madison Diner Car
33-6215 \$44.95



Baltimore & Ohio - O-27 Madison Combine Car
33-6214 \$44.95



- Set Features:**
- Die-Cast Steam Locomotive
 - 3-Car Passenger Consist
 - 31" x 51" 12-Piece RealTrax® Oval
 - Z-1000™ Transformer With Controller
 - Lighted Track Lock-On
 - RailWare™ Interactive DVD With Track Layout Software

- Locomotive Features:**
- Die-Cast Boiler and Chassis
 - Flywheel-Equipped Motor
 - Locomotive Speed Control
 - Operating Headlight
 - Remotely Controlled Proto-Coupler™
 - Synchronized Puffing Proto-Smoke™ Unit
 - All-Metal Wheels and Gears
 - Proto-Sound® 2.0 Sound System Featuring Passenger Station Proto-Effects™
 - Locomotive Measures: 19 1/4" x 2 1/2" x 3 3/4"

The Baltimore & Ohio railroad was America's oldest railroad, stretching from the East Coast to the Mid-West and South, providing an important link for both coal and passenger traffic during its peak years. In fact, its first railroad station, America's oldest, was located in Ellicott City, Maryland, just a few minutes from M.T.H.'s headquarters. The original structure still stands today, serving as an annex of the B&O Railroad Museum.

Although long gone, the B&O continues its popularity among model railroad fans today, who continue to appreciate its colorful passenger train consists like that seen in our 2006 set, headed up by a near-scale 2-8-0 locomotive that comes outfitted with all-metal gears, wheels and axles to ensure a lifetime of fun.

The unique sounds of Proto-Sound® 2.0 will amaze your friends and family. Imagine their faces when the whistle wails or the exclusive Passenger Station Proto-Effects™ begin calling out the next station stop on the line - just like the real stations! Of course, seeing the synchronized puffing smoke from the locomotive as it pulls its three-car passenger consist with die-cast metal trucks and operating metal couplers is even more impressive and tells all who see it that this is one great set. As with all RailKing® Ready-to-Run sets, the 12-piece RealTrax® oval assembles in minutes and can be placed right on the carpet or floor for a quick, temporary layout.

- Passenger Cars Feature:**
- Intricately Detailed Durable ABS Bodies
 - Die-Cast 6-Wheel Trucks
 - Operating Die-Cast Metal Couplers
 - Colorful, Attractive Paint Schemes
 - Detailed Car Interiors
 - Overhead Interior Lighting
 - Fast-Angle Wheel Sets
 - Needle-Point Axles
 - Metal Wheels and Axles
 - Passenger Cars Measure: 13 3/4" x 2 1/2" x 3 1/2"



PENNSYLVANIA 2-8-0 STEAM



Pennsylvania - 2-8-0 Steam Passenger Train Set
30-4137-1 w/Proto-Sound® 2.0 \$349.95

EXPAND YOUR SET WITH EXTRA CARS



Pennsylvania - O-27 Madison Combine Car
33-6210 \$44.95



Pennsylvania - O-27 Madison Coach Car
33-6209 \$44.95



Pennsylvania - O-27 Madison Diner Car
33-6218 \$44.95



- Set Features:**
- Die-Cast Steam Locomotive
 - 3-Car Passenger Consist
 - 31" x 51" 12-Piece RealTrax® Oval
 - Z-1000™ Transformer With Controller
 - Lighted Track Lock-On
 - RailWare™ Interactive DVD With Track Layout Software

- Locomotive Features:**
- Die-Cast Boiler and Chassis
 - Flywheel-Equipped Motor
 - Locomotive Speed Control
 - Operating Headlight
 - Remotely Controlled Proto-Coupler™
 - Synchronized Puffing Proto-Smoke™ Unit
 - All-Metal Wheels and Gears
 - Proto-Sound® 2.0 Sound System Featuring Passenger Station Proto-Effects™
 - Locomotive Measures: 19 1/4" x 2 1/2" x 3 3/4"

For decades the Pennsylvania Railroad was America's largest railroad, stretching from the East Coast to the Mid-West, moving untold amounts of freight and thousands of passengers every day. Although long gone, the spirit of the Pennsylvania is as strong today as it was in its heyday. Featuring a near-scale locomotive, the Pennsy Keystone 2-8-0 ready-to-run passenger train set comes decorated in classic Pennsylvania livery and features a heavy 2-8-0 steam locomotive with all-metal gears, wheels and axles to ensure a lifetime of fun.

The unique sounds of Proto-Sound® 2.0 will amaze your friends and family. Imagine their faces when the whistle wails or the exclusive Passenger Station Proto-Effects™ begin calling out the next station stop on the line - just like the real stations! Of course, seeing the synchronized puffing smoke from the locomotive as it pulls its three-car passenger consist with die-cast metal trucks and operating metal couplers is even more impressive and tells all who see it that this is one great set. As with all RailKing Ready-to-Run sets, the 12-piece RealTrax® oval assembles in minutes and can be placed right on the carpet or floor for a quick, temporary layout.

- Passenger Cars Feature:**
- Intricately Detailed Durable ABS Bodies
 - Die-Cast 6-Wheel Trucks
 - Operating Die-Cast Metal Couplers
 - Colorful, Attractive Paint Schemes
 - Detailed Car Interiors
 - Overhead Interior Lighting
 - Fast-Angle Wheel Sets
 - Needle-Point Axles
 - Metal Wheels and Axles
 - Passenger Cars Measure: 13 3/4" x 2 1/2" x 3 1/2"

SANTA FE SCALE F-3



Santa Fe- Scale F-3 Diesel Deluxe Passenger Train Set
30-4144-1 \$499.95

CHROME-PLATED FINISH!

EXPAND YOUR SET WITH EXTRA CARS



Put your railroad to work with this deluxe Santa Fe Ready-To-Run diesel passenger set. Bearing the markings of one of America's most famous railroads, this scale sized set makes a great beginning for any family's first model train.

The scale sized Santa Fe F-3 diesel's classic warbonnet livery has been brightened up thanks to the chrome plated car body that houses the locomotive's powerful 2-motored chassis. Outfitted with all-metal wheels and gears, the engine runs as good as it looks and comes equipped with digital sound and revolutionary speed control features found only in RailKing® Ready-to-Run train sets. Included are three well detailed 60' chrome plated passenger cars, each outfitted with a detailed interior and all-metal trucks, operating couplers, and metal wheels and axles ensuring years and years of fun operation.

Imagine the faces of friends and family when the horn wails or the exclusive Passenger Station Proto-Effects™ begin playing the sounds of a busy train station - calling out the next train and destination. Of course, seeing the flash of chrome and color when the locomotive rushes past while pulling its three distinctive cars is even more impressive and tells all who see it that this is one great set. As with all RailKing® Ready-to-Run sets, the 12-piece RealTrax® oval assemblies in minutes and can be placed right on the carpet for a quick, temporary layout.



Santa Fe- Scale F-3 A Unit Diesel (Non-Powered)
30-2482-3 \$109.95



Santa Fe- Scale F-3 B Unit Diesel (Non-Powered)
30-2482-4 \$99.95



Santa Fe- 60' Streamlined ABS Coach Car
30-67214 \$49.95



Santa Fe- 60' Streamlined ABS Full-Length Vista Dome Car
30-67215 \$49.95

- Set Features:**
- Two-Motored Scale Sized Diesel Locomotive
 - 31" x 51" 12-Piece RealTrax® Oval
 - 3-Car 60' Passenger Consist
 - RailWare™ Interactive DVD With Track Layout Software
 - Z-1000™ Transformer With Controller
 - Lighted Track Lock-On

- Locomotive Features:**
- Durable ABS Body and Metal Chassis
 - (2) Flywheel-Equipped Motors
 - Locomotive Speed Control
 - Electronic Reverse Unit
 - (2) Remotely Controlled Proto-Couplers™
 - Operating Headlight
 - All-Metal Wheels and Gears
 - Proto-Sound® 2.0 Sound System Featuring Passenger Station Proto-Effects™
 - Locomotive Measures: 13 1/2" x 2 3/8" x 3 1/2"

- Passenger Cars Feature:**
- Intricately Detailed Durable ABS Bodies
 - Die-Cast 4-Wheel Trucks
 - Operating Die-Cast Metal Couplers
 - Colorful, Attractive Paint Schemes
 - Detailed Car Interiors
 - Operating Overhead Lighting
 - End-of-Car Diaphragms
 - Fast-Angle Wheel Sets
 - Needle-Point Axles
 - Metal Wheels and Axles



NEW YORK GIANTS 2-8-0 STEAM



FEATURING EXCITING NFL RADIO PLAY-BY-PLAY PROTO-EFFECTS™ INCLUDING:

- SIMMS TO BAVARO SUPER BOWL CATCH
- TAYLOR SACKS THEISMANN
- NORWOOD MISSES FIELD GOAL IN SUPER BOWL
- ANDERSON'S SUPER BOWL TD RUN



New York Giants - 2-8-0 Steam Train Set
30-4151-1 w/Proto-Sound® 2.0 \$349.95



**EXPAND YOUR SET
WITH EXTRA CARS**

This colorful O Gauge freight set brings the rugged excitement of the NFL to model railroading for a unique and interactive family activity sure to spark memories of great NFL action.

This set is headed up by a powerful die-cast metal 2-8-0 Consolidation locomotive sporting the NFL New York Giants colors is a heavy locomotive that feels as strong as it runs. Its all-metal gears, wheels and axles will ensure a lifetime of fun and the unique sounds of Proto-Sound 2.0 will amaze your friends and family.

Imagine their faces when the whistle is activated but sounds the shrill of a referee's whistle, or when the bell is activated triggering the introduction of the Giants. Even more impressive are our exclusive NFL Proto-Effects that play back classic New York Giants radio play-by-play calls. Of course, seeing the synchronized puffing smoke from the locomotive as it pulls its three distinctive freight cars with sprung die-cast metal trucks and operating metal couplers is even more impressive and tells all who see it that this is one great set. As with all RailKing Ready-to-Run sets, the 12-piece RealTrax oval assembles in minutes and can be placed right on the carpet or floor for a quick, temporary layout.



New York Giants - 4-Bay Hopper Car
30-75218 \$44.95



**CHROME
PLATED**

New York Giants - Tank Car
30-73196 \$44.95



New York Giants - Flat Car w/ Trailer
30-76210 \$44.95

- Set Features:**
- Die-Cast Steam Locomotive
 - 3-Car Freight Consist
 - RailWare™ Interactive DVD With Track Layout Software
 - 31" x 51" 12-Piece RealTrax® Oval
 - Z-1000™ Transformer With Controller
 - Lighted Track Lock-On

- Locomotive Features:**
- Die-Cast Boiler and Chassis
 - Flywheel-Equipped Motor
 - Locomotive Speed Control
 - Remotely Controlled Proto-Coupler™
 - Operating Headlight
 - Synchronized Puffing ProtoSmoke™ Unit
 - All-Metal Wheels and Gears
 - Proto-Sound® 2.0 Sound System Featuring NFL Proto-Effects™
 - Locomotive Measures: 19 1/4" x 2 1/2" x 3 3/8"

- Freight Cars Feature:**
- Intricately Detailed Durable ABS Bodies
 - Die-Cast 4-Wheel Trucks
 - Operating Die-Cast Metal Couplers
 - Colorful, Attractive Paint Schemes
 - Fast-Angle Wheel Sets
 - Needle-Point Axles
 - Metal Wheels and Axles
 - Sliding Car Doors (box car only)
 - Freight Cars Measure: 10 3/4" x 2 3/8" x 3 1/8"



 © 2006, NFL Enterprises LLC. NFL and the NFL shield design are registered trademarks of the National Football League. The team names, logos and uniform designs are registered trademarks of the teams indicated.



FEATURING EXCITING NFL RADIO
PLAY-BY-PLAY PROTO-EFFECTS™ OF EACH
STEELERS SUPER BOWL VICTORY

PITTSBURGH STEELERS SCALE DASH 8



**Pittsburgh Steelers -
Switch Tower**
30-90142 \$49.95
Unit Measures: 6 1/8" x 10 1/2" x 9"

Pittsburgh Steelers - Scale Dash 8 Diesel Train Set
30-4171-1 w/Proto-Sound® 2.0 \$499.95



- Set Features:**
- Two-Motored Scale Sized Diesel Locomotive
 - 31" x 51" 12-Piece RealTrax® Oval
 - 5-Car Freight Consist
 - RailWare™ Interactive DVD With Track Layout Software
 - Z-1000™ Transformer With Controller
 - Lighted Track Lock-On

- Locomotive Features:**
- Durable ABS Body and Metal Chassis
 - (2) Flywheel-Equipped Motors
 - Locomotive Speed Control
 - Electronic Reverse Unit
 - (2) Remotely Controlled Proto-Couplers™
 - Operating Headlight
 - All-Metal Wheels and Gears

- Proto-Sound® 2.0 Sound System Featuring NFL Proto-Effects™
- Locomotive Measures: 18 1/8" x 2 15/16" x 4 1/4"

- Freight Cars Feature:**
- Intricately Detailed Durable ABS Bodies
 - Die-Cast 4-Wheel Trucks
 - Operating Die-Cast Metal Couplers

- Colorful, Attractive Paint Schemes
- Fast-Angle Wheel Sets
- Needle-Point Axles
- Metal Wheels and Axles
- Box Car Measures: 11 1/2" x 2 3/8" x 2 5/16"
- Lighted Caboose Measures: 10 1/4" x 2 1/2" x 4 1/4"



© 2006, NFL Enterprises LLC. NFL and the NFL shield design are registered trademarks of the National Football League. The team names, logos and uniform designs are registered trademarks of the teams indicated.

Introduce someone you love to model railroading with the magic of a RailKing® Ready-To-Run trolley set or take advantage of the way it complements your own holiday decor when set up around the Christmas tree.

The colorful trolley features a lighted interior, metal wheels and gears and a long-lasting motor. The unit operates on any O Gauge track system including the easy-to-assemble RealTrax system found inside each set. Optional track bumpers can be added to take advantage of the Automatic Bumper Reversing Mechanism (ABRM) that changes the trolley's direction when it hits a track bumper.



NFL TROLLEY SET



Pittsburgh Steelers - Trolley R-T-R Train Set
30-4169-1 \$129.95



New York Jets - Trolley R-T-R Train Set
30-4167-1 \$129.95



Philadelphia Eagles - Trolley R-T-R Train Set
30-4168-1 \$129.95



New York Giants - Trolley R-T-R Train Set
30-4166-1 \$129.95



Baltimore Ravens - Trolley R-T-R Train Set
30-4161-1 \$129.95



Cincinnati Bengals - Trolley R-T-R Train Set
30-4163-1 \$129.95



Dallas Cowboys - Trolley R-T-R Train Set
30-4165-1 \$129.95



Chicago Bears - Trolley R-T-R Set
30-4162-1 \$129.95



Washington Redskins - Trolley R-T-R Set
30-4170-1 \$129.95

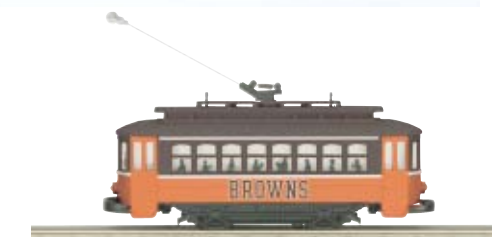

Cleveland Browns - Trolley R-T-R Set
30-4164-1 \$129.95



- Set Features:**
- Operating Trolley Car
 - RailWare™ Interactive DVD With Track Layout Software
 - 31" x 31" 8-Piece RealTrax® Oval
 - ZDC Transformer With Controller
 - Lighted Track Lock-On

- Trolley Features:**
- Detailed ABS Body
 - Powerful Motor
 - Automatic Reversing Bumpers
 - Operating Headlight
 - Moveable Power Pole
 - Lighted Interior
 - All-Metal Wheels and Gears
 - Measure: 8 1/4" x 2 3/8" x 3 1/3"
 - Operates On O-27 Curves

AUTOMATIC BUMP-REVERSE

While our trolley sets come with a circle of track, their bump-reverse feature allows continuous point-to-point operation as well. The trolley automatically reverses direction each time it hits a bumper.

(For additional RealTrax and lighted bumpers, see pages 38-41.)



BUMPERS SOLD SEPARATELY



© 2006, NFL Enterprises LLC. NFL and the NFL shield design are registered trademarks of the National Football League. The team names, logos and uniform designs are registered trademarks of the teams indicated.

NEW YORK CENTRAL 260E O-GAUGE STEAM SET



**EQUIPPED WITH
REMOTELY OPERATING
"BOX-TYPE" PROTO-COUPLER™**

New York Central - 263E Steam Freight Train Set
10-3021-1 w/Proto-Sound® 2.0 \$599.95

**EXPAND YOUR SET
WITH EXTRA CARS**



Like its standard gauge cousins on the following pages, this O gauge New York Central steam set embodies the gleaming sheet metal beauty of the tinplate era. The original 260E locomotive, introduced by Lionel® in 1936, represented the last hurrah of tinplate. Within a few years, most toy trains would be far more realistic - if less charming - plastic and die-cast models of real-life trains.

While it harks back to the decades before World War II, this tinplate freight set runs on the same O gauge RealTrax® as every RailKing® model. And while its exterior is pure 1930s, thanks to Proto-Sound® 2.0 electronics our 260E steamer delivers smoother operation than any original tinplate locomotive, as well as huge plumes of puffing smoke - timed to the driver's revolutions - and a clanging bell and wailing whistle guaranteed to delight children of all ages. Our replica of the 260E is outfitted with an all-new "Box-Type" Proto-Coupler™ that can be remotely activated by the transformer to uncouple from its trailing three freight cars, each decorated with bright metal trim and colorful baked enamel paint.

WHAT IS TINPLATE?

Popular from the early twentieth century until the beginning of World War II, tinplate trains were the product of an era when toy trains indeed looked like toys, and prototype accuracy was less important than artistry and bright colors. Like the originals, M.T.H. Tinplate Traditions models are made of stamped and die-cast metal and finished in bright metal plating and shiny baked enamel paint - enabling you to enjoy the same excitement that a child felt when receiving these toys as a holiday or birthday present seven or eight decades ago.

Tinplate Traditions trains come in two sizes: O gauge, like the RailKing trains shown elsewhere in this catalog, and Standard Gauge, which is almost twice the size of O gauge and peaked in popularity in the 1920s and 1930s.



**New York Central - 2800 Series
O Gauge Hopper Car**
10-8023 \$79.95

- Set Features:**
- All-Metal Steam Locomotive
 - 3-Car Freight Consist
 - RailWare™ Interactive DVD With Track Layout Software
 - 31" x 51" 12-Piece RealTrax® Oval
 - Z-1000™ Transformer With Controller
 - Lighted Track Lock-On
 - RailWare Interactive DVD w/Track Layout Software

- Locomotive Features:**
- Die-Cast Chassis
 - Stamped Metal Boiler & Tender
 - Flywheel-Equipped Motor
 - Locomotive Speed Control
 - Electronic Reverse Unit
 - Remotely Operated "Box-Type" Proto-Coupler™
 - Operating Headlight
 - Synchronized Puffing Proto-Smoke™ Unit
 - All-Metal Wheels and Gears
 - Proto-Sound® 2.0 Sound System Featuring Freight Yard Proto-Effects™
 - Locomotive Measures: 21 1/2" x 3 3/8" x 4"

- Freight Cars Feature:**
- Stamped Steel Bodies
 - All-Metal 4-Wheel Trucks
 - Operating Metal Latch Couplers
 - Colorful, Attractive Paint Schemes
 - Metal Wheels and Axles
 - Sliding Car Doors (boxcar only)
 - Freight Cars Measure: 10 1/4" x 2 5/8" x 3 7/8"

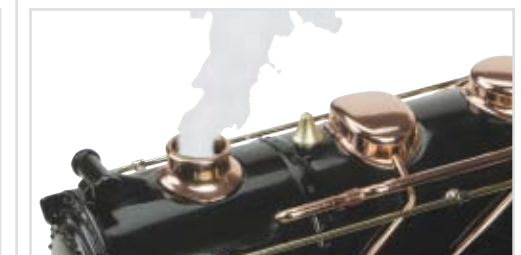



JERSEY CENTRAL NO. 384 STEAM SET

Jersey Central - No. 384 Steam Passenger Set
10-1251-1 w/Proto-Sound® 2.0 \$599.95

EXPAND YOUR SET WITH EXTRA CARS

Standard gauge steam engines like the original 384 were not so much scale models of real locomotives, but cartoon-like caricatures: wildly oversized drivers, bright brass or nickel trim, colorful, gleaming paint, and a cast iron frame topped by a sheet metal boiler and cab. Our Tinplate Traditions Jersey Central set replicates the magic of the tinplate trains that gladdened the heart of many a child in the early decades of the 20th century.

The bright colors of this set are inspired by Jersey Central name trains like the Blue Comet, which sped vacationers along the New Jersey shoreline in the early 20th century. Thanks to Proto-Sound® 2.0 electronics, our 384 steamer delivers smoother operation than any original standard gauge locomotive, as well as huge plumes of puffing smoke - timed to the driver's revolutions - and a clanging bell and wailing whistle guaranteed to delight children of all ages. Our replica of the 384 is trailed by two passenger cars decorated with bright metal trim and colorful baked enamel paint.



Jersey Central - 330 Series Passenger Car
10-5060 \$129.95

Today M.T.H. is the only manufacturer offering a full line of standard gauge and O gauge trains that faithfully reproduce the magic of the pre-war tinplate era. See our latest Tinplate Traditions catalog online at www.mthtrains.com.

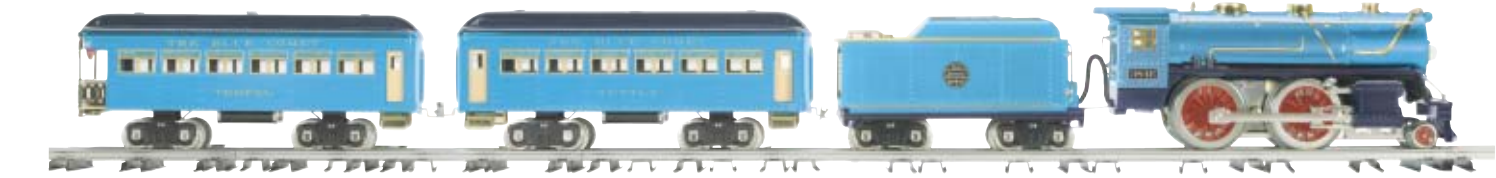

- Set Includes:**
- (8) STD 42" Curve Sections
 - Lighted Track Lock-On
 - Wire Harness
 - No. 384 Steam Locomotive
 - (2) 300 Series Passenger Cars
 - Z-1000™ Transformer With Controller
 - RailWare Interactive DVD w/Track Layout Software

- Locomotive Features:**
- Die-Cast Metal Chassis
 - Baked Enamel Finish
 - Operating Metal Latch Couplers
 - Metal Wheels, Gears and Axles
 - Stamped Steel Body
 - Locomotive Speed Control
 - Synchronized Puffing ProtoSmoke™ Unit
 - Operating Headlight
 - Locomotive Measures: 22 3/4" x 7 5/8" x 5"
 - Proto-Sound® 2.0 Featuring Passenger Station Proto-Effects™

- Passenger Car Features:**
- Baked Enamel Finish
 - Operating Metal Latch Couplers
 - Metal Wheels and Axles
 - Stamped Steel Body
 - Cars Measure: 14 1/2" x 3 1/8" x 4 3/4"



CHESSIE NO. 384 STEAM SET

Chessie - No. 384 Steam Passenger Set
10-1236-1 w/Proto-Sound® 2.0 \$599.95

EXPAND YOUR SET WITH EXTRA CARS

In many respects, the No. 384 is the quintessential toy steamer owned by thousands of boys in the early twentieth century: wildly oversized drivers, bright brass or nickel trim, colorful, gleaming paint, and a cast iron frame topped by a sheet metal boiler and cab. Our Tinplate Traditions 384 Chessie set replicates the starter sets that gladdened the heart of many a child in the early decades of the 20th century. The bright colors of this set, however, are inspired by the Chessie Steam Specials run for railfans in the late 1970s.

Thanks to Proto-Sound® 2.0 electronics, our 384 steamer delivers smoother operation than any original standard gauge locomotive, as well as huge plumes of puffing smoke - timed to the driver's revolutions - and a clanging bell and wailing whistle guaranteed to delight children of all ages. Our replica of the 384 is trailed by two passenger cars decorated with bright metal trim and colorful baked enamel paint.



Chessie - 330 Series Passenger Car
10-5049 \$129.95

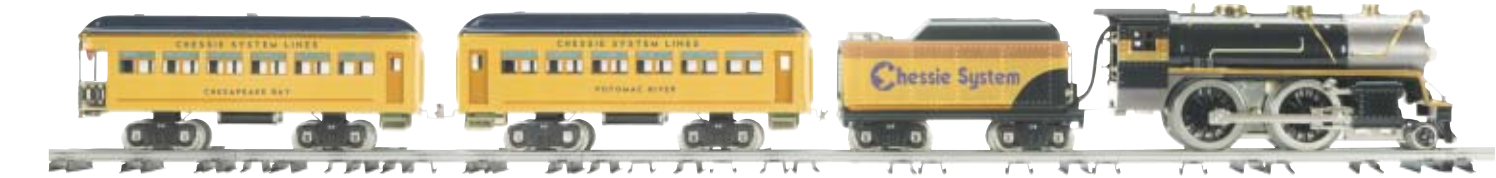

- Set Includes:**
- (8) STD 42" Curve Sections
 - Lighted Track Lock-On
 - Wire Harness
 - No. 384 Steam Locomotive
 - (2) 300 Series Passenger Cars
 - Z-1000™ Transformer With Controller
 - RailWare Interactive DVD w/Track Layout Software

- Locomotive Features:**
- Die-Cast Metal Chassis
 - Baked Enamel Finish
 - Operating Metal Latch Couplers
 - Metal Wheels, Gears and Axles
 - Stamped Steel Body
 - Locomotive Speed Control
 - Synchronized Puffing ProtoSmoke™ Unit
 - Operating Headlight
 - Proto-Sound® 2.0 Featuring Passenger Station Proto-Effects™
 - Locomotive Measures: 22 3/4" x 7 5/8" x 5"

- Passenger Car Features:**
- Baked Enamel Finish
 - Operating Metal Latch Couplers
 - Metal Wheels and Axles
 - Stamped Steel Body
 - Cars Measure: 14 1/2" x 3 1/8" x 4 3/4"

In many respects, the No. 384 is the quintessential standard gauge steamer owned by thousands of boys in the early twentieth century: wildly oversized drivers, bright brass or nickel trim, colorful, gleaming paint, and a cast iron frame topped by a sheet metal boiler and cab. Our Tinplate Traditions 384 Christmas set replicates the starter sets that gladdened the heart of many a child on a holiday or birthday in the early 1930s - with one exception.

Thanks to Proto-Sound® 2.0 electronics, our 384 steamer delivers smoother operation than any original standard gauge locomotive, as well as huge plumes of puffing smoke - timed to the driver's revolutions - and a clanging bell and wailing whistle guaranteed to delight children of all ages. Our replica of the 384 is trailed by two passenger cars decorated with bright metal trim and colorful baked enamel paint.

EXPAND YOUR SET WITH EXTRA CARS



Christmas - 330 Series Passenger Car
10-5059 \$129.95



Christmas - 500 Series Std. Gauge Cattle Car
10-2160 \$99.95



Christmas - 200 Series Std. Gauge Flat Car w/Fire Truck
10-2159 \$149.95

- Set Includes:
- (8) STD 42" Curve Sections
 - Lighted Track Lock-On
 - Wire Harness
 - No. 384 Steam Locomotive
 - (2) 300 Series Passenger Cars
 - Z-1000™ Transformer With Controller
 - RailWare Interactive DVD w/Track Layout Software

- Locomotive Features:
- Die-Cast Metal Chassis
 - Baked Enamel Finish
 - Operating Metal Latch Couplers
 - Metal Wheels, Gears and Axles
 - Stamped Steel Body
 - Locomotive Speed Control
 - Synchronized Puffing ProtoSmoke™ Unit
 - Operating Headlights
 - Locomotive Measures: 22 3/4" x 7 5/8" x 5"
 - Locomotive Equipped With Proto-Sound® 2.0 Featuring Passenger Station Proto-Effects™

- Passenger Car Features:
- Baked Enamel Finish
 - Operating Metal Latch Couplers
 - Metal Wheels and Axles
 - Stamped Steel Body
 - Cars Measure: 14 1/2" x 3 1/8" x 4 3/4"



CHRISTMAS NO. 384 STEAM SET

Christmas - No. 384 Steam Passenger Set
10-1250-1 w/Proto-Sound® 2.0 \$599.95



TINPLATE TRACK

The standard gauge track on this page has rails spaced 2 1/8" apart, while the O gauge track pictured elsewhere in this catalog has a gauge of 1 1/4".

IT TAKES **TWELVE O-42 CURVES** TO MAKE A CIRCLE.
IT TAKES **SIXTEEN O-72 CURVES** TO MAKE A CIRCLE.
IT TAKES **SIXTEEN O-82 CURVES** TO MAKE A CIRCLE.



Std. Gauge Track - 1/2 Reg. Straight
10-1034 \$2.99



Std. Gauge Track - Reg. Straight
10-1038 \$3.99



Std. Gauge Track - Straight w/Extra Ties
10-1040 \$4.49

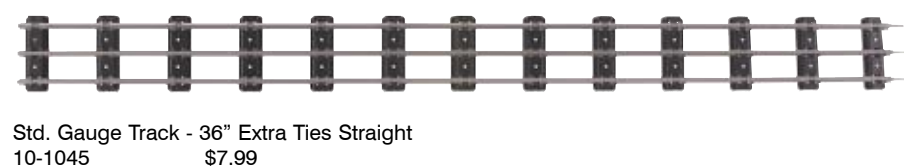

Std. Gauge Track - 36" Extra Ties Straight
10-1045 \$7.99

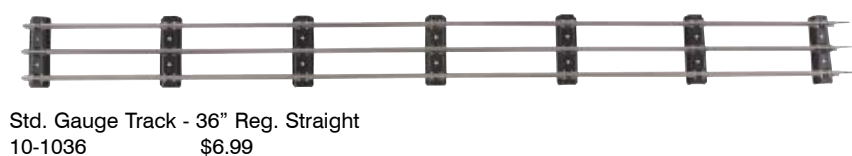

Std. Gauge Track - 36" Reg. Straight
10-1036 \$6.99



Std. Gauge Track - 42 Reg. 1/2 Curved
10-1035 \$2.99



Std. Gauge Track - 42" Dia. Reg. Curved
10-1039 \$3.99



Std. Gauge Track - 72" Dia. Wide Radius Curve
10-1041 \$4.49



Std. Gauge Track - 84" Dia. Curved
10-4020 \$4.99

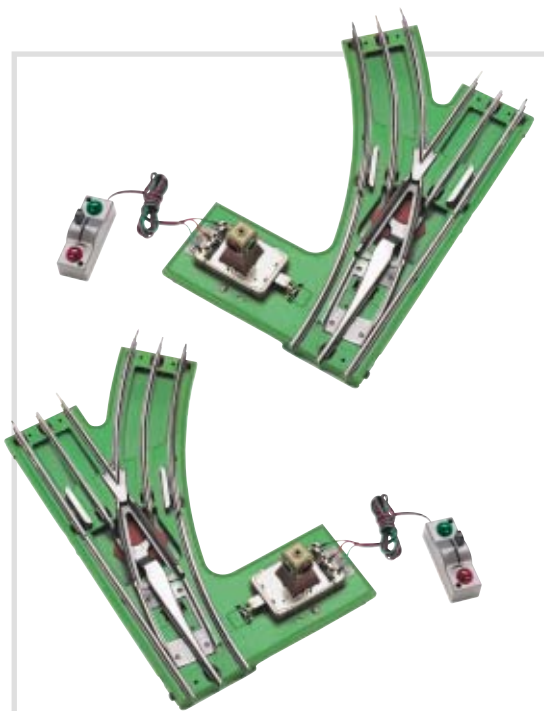

Std. Gauge Switch - Right Hand O-42
10-4001 \$79.95

Std. Gauge Switch - Left Hand O-42
10-4002 \$79.95

Std. Gauge Switch (Wide Radius) - Right Hand O-72
10-4003 \$89.95

Std. Gauge Switch (Wide Radius) - Left Hand O-72
10-4004 \$89.95



O/Std. Gauge Lighted Lockon
10-1021 \$3.99

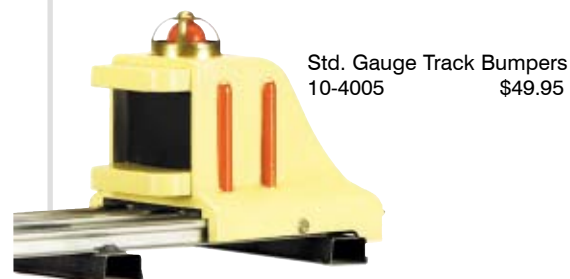

Std. Gauge Track Bumpers
10-4005 \$49.95

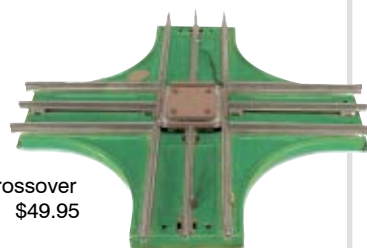

Std. Gauge 90* Crossover
10-4006 \$49.95

TRANSFORMERS



Z-750 Transformer
40-750 \$79.95

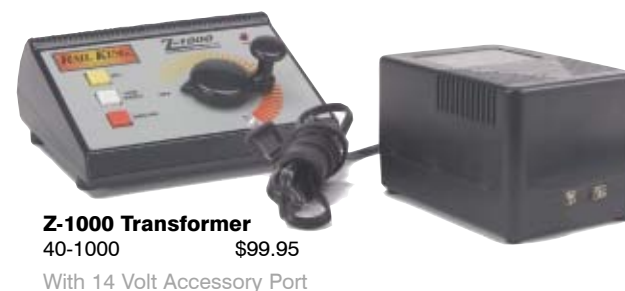

Z-1000 Transformer
40-1000 \$99.95
With 14 Volt Accessory Port



RealTrax Wire Harness
40-1015 \$3.99



100-Watt Accessory Power Supply
40-1000B \$79.95

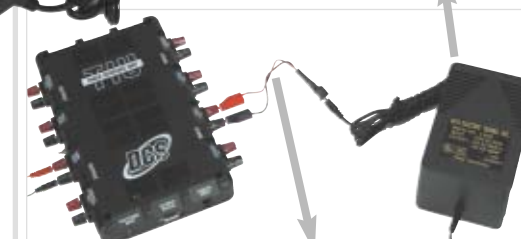

TIU/Barrel Jack Adapter Cable
50-1017 \$9.95



Z-4000 Transformer
40-4000 \$429.95

400 Watts!
The Most Powerful
U.L. Listed
Transformer!

While the power pack that comes with every RailKing Ready-To-Run set provides plenty of power to operate your set & several additional cars, you'll find as you add more track, cars, & accessories to your layout that you need more power to keep everything running. Fortunately, RailKing has you covered.

If you want to power up gradually, you can purchase additional 50-watt Z-500™, 75-watt Z-750™ or 100 watt Z-1000™ transformers as the need arises. Featuring a U.L. approved design, each model utilizes a separate controller which contains bell, horn & direction buttons that can control any manufacturer's locomotives & sound systems including Proto-Sound® equipped steam, diesel & electric locomotives.

If you want to max out your power potential, the 400-watt Z-4000® is the most powerful transformer to receive the UL-listing for the model railroading hobby. The Z-4000 has two separate throttles to let you power two different tracks, & it has two fixed power outputs you can use for operating accessories. A single Z-4000 will power a lot of layout.

DCS users who don't need a conventional transformer and controller can use this 100 watt power supply for small and moderate sized layouts. Featuring a U.L. approved design & separate 14v AC Accessory Port, its robust design will provide years of service. Use the optional TIU/Barrel Jack adapter to make connecting it to the DCS Track Interface Unit quick and easy.

WHY THE U.L. LISTING?
M.T.H. Electric Trains is committed to manufacturing safe, U.L. approved transformers and power supplies. By subjecting our transformers to the strenuous tests and requirements of the U.L. laboratories, M.T.H. helps ensure that these products meet the same requirements as other consumer electronics sold today. When choosing a new transformer, model railroaders should only look for those that have received a U.L. listing.



SIMPLY THE BEST WAY TO RUN A RAILROAD

There is a new way of controlling model railroads today that you've got to see to believe. It's called DCS™ (for Digital Command System) and it's the most revolutionary product to hit model railroading since locomotives first became equipped with sound!

Unlike traditional or conventional means of operating a model railroad, command systems allow the user to independently control each engine even if other engines are on the same track at the same time. The concept has been around since the early 1990's, but only DCS™ makes it simple and easy to use — thanks to its state-of-the art technology and intuitive interface.

Upgrading to DCS unlocks more features than you'll find in any other command control operat-

ing system — features that are factory-installed in every Proto-Sound® 2.0 train set locomotive. Here's just a partial list of what DCS offers:

WIRELESS HANDHELD THROTTLE
Run your whole railroad — locomotives, accessories, everything — from one or more DCS handheld remotes. An LCD screen indicates which engine you're controlling and its current speed, adjustable in one-scale-mile-per-hour increments. Program engines and accessories on the same screen. For nighttime operation, turn on the screen's backlight.

COMMAND CONTROL
Operate up to 99 DCS-equipped engines independently at the same time on the same electrically continuous track — using one or several DCS wireless handheld remotes. When you have guests, give each visitor a DCS handheld and let them control their own engine. Just like

the prototype, you can double-head locomotives, add or drop helper engines, or bring a train into the station with a mainline engine and then have a switcher break up the consist.

PROTO-SOUND® 2.0 ENGINE SOUNDS
DCS offers individual control of dozens of sounds built into every M.T.H. locomotive. Rev the diesel motor up manually before moving your train. Activate auxiliary sounds such as steam letoff and crew conversations. Whistle, bell, and steam chuff or diesel prime mover sounds even have independently adjustable volume control.

TRAIN SOUNDS
Add ambience to your railroad with the variety of train sounds built into Proto-Sound® 2.0. The DCS handheld gives you access to effects such as wheel clickety-clack, coupler opening sounds, and the Doppler effect of a train passing

by. DCS also offers one-button activation of the Passenger Station or Freight Yard Proto-Effects™ built into every Proto-Sound® 2.0 locomotive.

SMOKE CONTROL
Adjust the smoke intensity for a steam or diesel engine at any time from the DCS remote.

CONSTANT LIGHTING
Because DCS operates with a constant voltage on the rails (most operators use 18 volts), engine, caboose, and passenger car lights are always on at a constant intensity. No more "lights-out" when a passenger train arrives at a station!

PROGRAMMABLE OPERATION
Record up to 90 minutes of DCS speed, direction, and sound commands as a program that your engines can repeat on demand. Use this feature to run trains auto-

matically on one part of your railroad while you manually control another area.

UPGRADABLE SOFTWARE
Unlike any DCC or any other command system, DCS is designed to be upgradable over the Internet. The latest software can be downloaded to any DCS system ever made, so new features can be added and your investment will not become obsolete.

TMCC® COMPATIBILITY
Add a Lionel® Command Base to your DCS system and you can run engines equipped with TMCC® (Lionel's TrainMaster® Command Control) side-by-side with DCS engines - all from the DCS handheld controller. If you prefer, you can even use a Lionel CAB-1® handheld to control TMCC engines at the same time you're controlling Proto-Sound engines with the DCS controller.

LISTEN TO YOUR FAVORITE TUNES WITH PROTO-CAST™
DCS is the only command control system that lets you hook up any audio source and play your favorite music right through the train!

BE YOUR OWN DISPATCHER
With DCS's built-in remote microphone, real-time radio dispatch calls are just a button push away.

COMMAND CONTROL EXPLAINED

In conventional operation, an AC or DC transformer varies track current to adjust engine speed and direction. Command systems such as DCS™, however, put a constant voltage on the track (around 18 volts for DCS) and vary speed by telling each engine how much of that voltage to use. Command control allows different engines to do different things - like run at different speeds, go in different directions, or make different sounds - even when they are on the same track.

In the DCS system, commands such as speed, direction, and sound control are sent as radio signals from the handheld throttle to a TIU (track interface unit). The TIU translates those radio signals into digital information that is sent through the rails and picked up by a receiver in the appropriate engine - telling it to go, for example, 37 miles per hour, blow the whistle, smoke more heavily, or any other command. DCS locomotives can also send information back to the handheld to let the operator know what they're doing.

INTUITIVE MENUS ALLOW YOU TO PROGRAM, SELECT, AND CONTROL ENGINES, SWITCHES, AND ACCESSORIES.

- Go to the engine set up menu
- Choose your engine type
- DCS will "look" for Proto-Sound® or TMCC command-equipped engines on your layout. When it finds one, it adds it onto your remote and tells you when it's done.

DCS WIRELESS REMOTE HANDHELD

- MICROPHONE**
- LCD DISPLAY**
- SOFTKEYS** - Activate locomotive features
- MIC** - Turns Proto-Dispatch™ on & off
- TR** - Track menu (access various tracks / blocks on your layout)
- SW** - Switch menu
- W/H** - Blows whistle/horn
- THUMBWHEEL** - Throttle & selection (scroll & press) tool
- DIR** - Changes locomotive direction
- CPLR-F/CPLR-R** - Fires front & rear couplers
- START UP** - Activates sound, smoke & lights
- SHUT DOWN** - Deactivates all sound, smoke & lights
- PFA** - Activates Passenger/Freight Sounds
- E-STOP** - Cuts power to all tracks
- DOPPLER** - Activates Proto-Doppler™
- Programming Port** - Tether attaches between remote and TIU for programming new software features
- B/L** - Screen backlight on/off
- AUX** - Auxiliary menu
- ACC** - Accessory menu
- BELL** - Rings bell
- ENG** - Engine menu (to select and control engines)
- MENU** - Access 4 main menus: Sound, Control, System, Advanced
- LABOR/REV UP OR DRIFT/REV DN** - Makes an engine sound like it's working harder or easier
- BOOST/BRAKE** - Temporarily Raises or Lowers Speed
- SMOKE** - Turns smoke unit on & off
- VOL+** - Globally increases all sounds
- ENG SND** - Silences engine sounds
- VOL-** - Globally decreases all sounds
- HDLT** - Turns headlights on & off
- PROTOCAST** - Activates Proto-Cast™
- READ** - Search for TIUs, AIUs and Proto-Sound® 2.0 Engines on the track



EVERY PROTO-SOUND® 2.0 TRAIN SET LOCOMOTIVE IS ALREADY EQUIPPED TO RUN ON DCS.

DCS Remote Control System
50-1001 \$299.95

DCS COMPONENTS

DCS Remote Control - Handheld Unit
50-1002 \$149.95

DCS Track Interface Unit (TIU)
50-1003 \$179.95

DCS Accessory Interface Unit (AIU)
50-1004 \$99.95

Proto-Sound Battery
50-1008 \$9.95

AA NiCad Proto-Sound Battery
50-1024 \$9.95

Proto-Sound 2.0 Battery Charger
50-1019 \$14.95

TIU/TMCC 6' Connector Cable
50-1018 \$19.95

6' Mini-to-Mini Cable
50-1009 \$9.95

TIU/Barrel Jack Adapter Cable
50-1017 \$9.95

24-Port Terminal Block
50-1020 \$29.95

12-Port Terminal Block
50-1014 \$16.95

Video Guide To DCS - DVD
60-1191 \$19.95

Video Guide To DCS - VHS
60-1190 \$19.95

*TMCC operation requires a TMCC command base & DCS TIU/TMCC cable

MTH RealTrax track is superior to our competitors in both durability and electrical conductivity - two of the most important factors in choosing a track system for your layout.

First, MTH RealTrax rails are solid extrusions of nickel-silver. This material provides superior strength, durability, and corrosion resistance when compared to our competitors obsolete approach of using flimsy formed rails made of steel that will rust over time.

Next, MTH RealTrax has spring loaded phosphor bronze contacts that provide superior electrical connections. The contacts are spring loaded to maintain a solid connection over time and are highly resistant to corrosion of any kind. Similar materials are used in many electrical connections around your home such as lamps, battery operated appliances, and electrical outlets. Even our competitors so-called "new" track system still uses the outdated approach of plated steel pins inserted into steel rails for their connection. This obsolete approach is well known to rust and deteriorate into loose and intermittent electrical connections over time.

Imagine the frustration and expense of poor electrical track connections and ultimately having to replace the track on a finished layout!!!

Finally, a track system must have quality switches that can handle the constant wear and stress of locomotives and cars. RealTrax switches feature the same durable solid rails of regular RealTrax sections and utilize long-lasting switch motors that provide precise throws each and every time. Each switch is designed to fit into most configurations and its reverseable motor mechanism quickly snaps onto the other side of the switch in just seconds. No disassembly of the switch is required!

At M.T.H. we believe a track system should allow your model railroad empire to grow. The RealTrax system includes 72 different components for maximum expansion capabilities. Bridges, curves of all sizes, elevated and graduated trestles, crossovers and every straight and curve configuration you'll need to create your own model railroading empire.

REALTRAX®
BY M.T.H. ELECTRIC TRAINS

IT TAKES **EIGHT O-31 CURVES** TO MAKE A CIRCLE.
IT TAKES **TWELVE O-42 CURVES** TO MAKE A CIRCLE.
IT TAKES **TWELVE O-54 CURVES** TO MAKE A CIRCLE.
IT TAKES **SIXTEEN O-72 CURVES** TO MAKE A CIRCLE.
IT TAKES **SIXTEEN O-82 CURVES** TO MAKE A CIRCLE.

STRAIGHT TRACK SECTIONS

RealTrax - 3.5" Track Section 40-1018 \$3.50
RealTrax - 4.25" Track Section 40-1017 \$3.50
RealTrax - 5.0" Track Section 40-1016 \$3.50
RealTrax - 5.5" Track Section 40-1012 \$3.50
RealTrax - 10" Insulated Straight Track Section Set 40-1029 \$7.99
RealTrax - 10" Straight Track Section 40-1001 \$3.50
RealTrax - Adapter Track Section 40-1011 \$7.99
RealTrax - 10" Ground Track (2 pieces per pack) 40-1068-2 \$7.99
RealTrax - 30" Straight Track Section 40-1019 \$9.95

CROSSOVER AND OPERATING SECTIONS

RealTrax - 90* Crossover Track 40-1006 \$19.95
RealTrax - 45* Crossover Track 40-1007 \$19.95
RealTrax - Operating Track Section 40-1008 \$29.95

CURVED TRACK SECTIONS

RealTrax - O-31 Half Curve Track 40-1022 \$3.50
RealTrax - O-42 Half Curve Track 40-1045 \$3.99
RealTrax - O-54 Half Curve Track 40-1057 \$4.99
RealTrax - O-72 Half Curve Track Section 40-1049 \$4.99
RealTrax - O-31 Curved Track Section 40-1002 \$3.50
RealTrax - O-42 Curved Track Section 40-1042 \$3.99
RealTrax - O-54 Curved Track Section 40-1054 \$4.99
RealTrax - O-72 Curved Track Section 40-1010 \$4.99
RealTrax - O-82 Curved Track Section 40-1082 \$4.99

OPERATING SWITCHES

RealTrax - O-31 Switch (RH) 40-1004 \$49.95
RealTrax - O-42 Switch (RH) 40-1043 \$59.95
RealTrax - O-72 Wye Switch 40-1068 \$79.95
RealTrax - O-31 Switch (LH) 40-1005 \$49.95
RealTrax - O-42 Switch (LH) 40-1044 \$59.95
RealTrax - O-54 Switch (R) 40-1055 \$59.95
RealTrax - O-72 Switch (RH) 40-1020 \$69.95
RealTrax - O-54 Switch (L) 40-1056 \$59.95
RealTrax - O-72 Switch (LH) 40-1021 \$69.95
RealTrax - O-42/O-31 Curve Switch (LH) 40-1065 \$79.95
RealTrax - O-42/O-31 Curve Switch (RH) 40-1064 \$79.95
RealTrax - O-72/O-54 Curve Switch (LH) 40-1067 \$99.95
RealTrax - O-72/O-54 Curve Switch (RH) 40-1066 \$99.95



RealTrax - 24-Piece Graduated Trestle System
40-1033 \$29.95

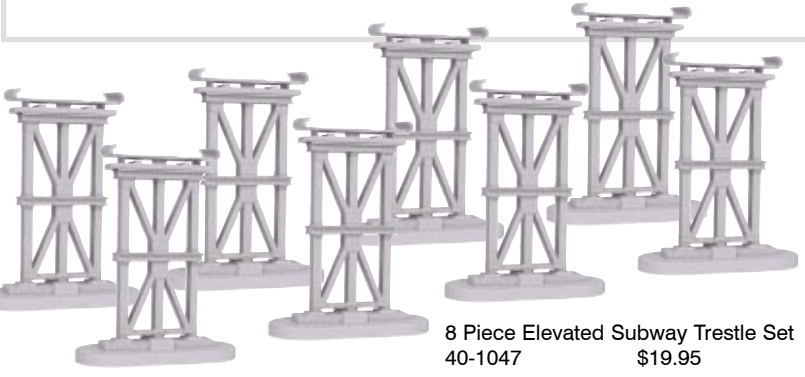

8 Piece Elevated Subway Trestle Set
40-1047 \$19.95



RealTrax - 8-Piece Elevated Trestle System
40-1034 \$19.95

CATENARY SYSTEMS



- CATENARY FEATURES:**
- Compatible with RealTrax® or any other O-Gauge Track
 - Removable RealTrax® Lock-On Base Connection
 - Thumbscrew Power Terminals
 - Adjustable Pole Spacing
 - Adjustable Messenger Beam Height
 - Adjustable Wire Positioning
 - Base Mounting Screws Included



RealTrax - 8-Piece Catenary System
40-1035 \$149.95

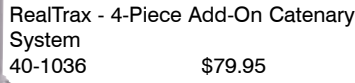

RealTrax - 4-Piece Add-On Catenary System
40-1036 \$79.95

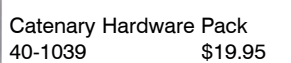

Catenary Hardware Pack
40-1039 \$19.95

LAYOUT BUILDERS



RealTrax - Right Hand Track Siding Layout Builder
40-1027 \$79.95
(Contains (1) Right-Hand O-31 Switch, (4) 10" Straights, (1) O-31 Curve, (1) RealTrax™ Bumper)

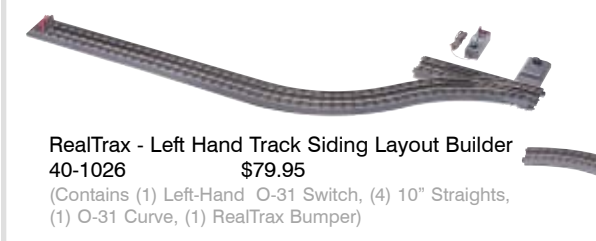

RealTrax - Left Hand Track Siding Layout Builder
40-1026 \$79.95
(Contains (1) Left-Hand O-31 Switch, (4) 10" Straights, (1) O-31 Curve, (1) RealTrax Bumper)

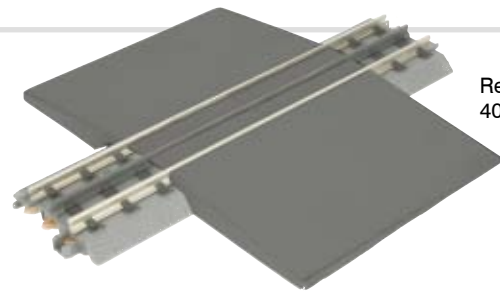

RealTrax - Grade Crossing
40-1009 \$9.95

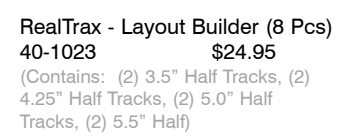

RealTrax - Layout Builder (8 Pcs)
40-1023 \$24.95
(Contains: (2) 3.5" Half Tracks, (2) 4.25" Half Tracks, (2) 5.0" Half Tracks, (2) 5.5" Half)

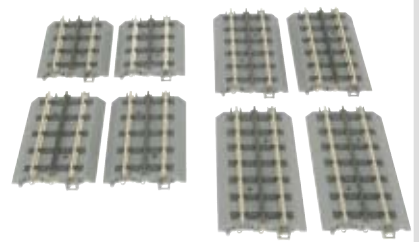

RealTrax - Figure 8 Layout Builder
40-1025 \$49.95
(Contains: (4) O-31 Curves, (4) 10" Straights, (1) Lighted Lockon, (1) 90 Degree Crossover)

TRACK SYSTEM ADD-ONS AND BRIDGE EQUIPMENT

- O Bridge Girder - Rust 40-1032 \$19.95
- O Bridge Girder - Black 40-1051 \$19.95
- O Bridge Girder - Silver 40-1014 \$19.95



- O 2-Track Bridge Girder - Rust 40-1059 \$29.95
- O 2-Track Bridge Girder - Black 40-1061 \$29.95
- O 2-Track Bridge Girder - Silver 40-1063 \$29.95



- O 2-Track Steel Arch Bridge - Rust 40-1058 \$89.95
- O 2-Track Steel Arch Bridge - Black 40-1060 \$89.95
- O 2-Track Steel Arch Bridge - Silver 40-1062 \$89.95



O Subway Trestle Bridge
40-1048 \$19.95



RealTrax - Track Activation Device (I.T.A.D.)
40-1028 \$19.95

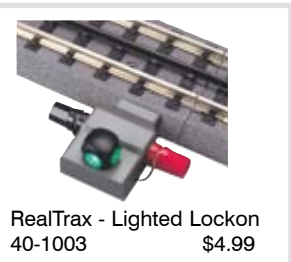

RealTrax - Lighted Lockon
40-1003 \$4.99



RealTrax - Lighted Bumper
40-1024 \$12.95



RealTrax - Non-Slip Track Pads (50/pack)
40-1046 \$4.95



RealTrax - Track Clips (24)
40-1041 \$7.95

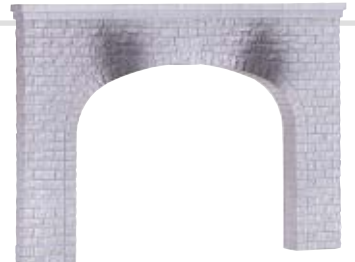

Tunnel Portal - Double
40-9015 \$19.95

Tunnel Portal - Single
40-9014 \$14.95



- O Steel Arch Bridge - Rust 40-1031 \$59.95
- O Steel Arch Bridge - Black 40-1050 \$59.95
- O Steel Arch Bridge - Silver 40-1013 \$59.95



ACCESSORIES

Warning signs like our operating crossing gate (complete with ringing warning bell, flashing lights and crossing arm that lowers) and traffic lights keep the townspeople safe. Streetlights and hi-tension towers turn your layout into a real-looking, recognizable town.

M.T.H. offers a variety of RailTown™ buildings to help you create whatever kind of atmosphere you desire: rural or urban, nostalgic or modern. Operating buildings transfer your layout's action from trains to structures adding fun and excitement to the entire pike. RailTown buildings are a perfect addition on any O Gauge layout, as each is sized for use with all O Gauge locomotives and rolling stock.

Many RailKing operating accessories bring a layout to life via real-world movement and operation. In addition to lights and signals there are many operating buildings. An SUV pulling through a McDonald's® drive-thru after ordering, a coaling tower that lifts bucketfuls of coal and dumps them into a waiting hopper car, a fill-up at the local gas station, log operations at the saw mill and much more are awaiting owners of RailKing operating buildings. Each fully assembled and ready to use means your layout transformation into a world of action is just a few minutes away.

As you peruse the next few pages, you'll find that we've divided the accessory section into four categories: RailTown buildings, traditional accessories that feature the classic "Tinplate" look for the mid-20th century, miscellaneous accessories like bags of coal or smoke fluid, and O Scale accessories complete with scale proportioned, well-detailed models that make a layout incredibly realistic.

- TRADITIONAL ACCESSORIES
- MISCELLANEOUS ACCESSORIES
- O SCALE ACCESSORIES



- 3-Rail Bettendorf Freight Car Two Truck Pack 30-89001 \$12.99
- 3-Rail Roller Bearing Freight Car Two Truck Pack 30-89002 \$12.99



- American Flag Pole/Flag 30-9074 \$19.95
Unit Measures: 4 3/8" x 10 3/8"



- Maintenance Kit 30-50010 \$14.95



LOOK FOR FOR
RAILTOWN BUILDINGS
AND RAILKING ACCESSORIES
AT YOUR LOCAL RETAILER



- ProtoSmoke™ Fluid (7oz.)

Unscented	60-1045	\$9.95
Christmas	60-1046	\$12.95
Coal	60-1047	\$12.95
Diesel	60-1048	\$12.95
Woodburning	60-1049	\$12.95

- ProtoSmoke™ Fluid (2 Oz.)

Assortment (36 pieces)	60-1051	\$179.95
Christmas	60-1051-a	\$4.99
Coal	60-1051-b	\$4.99
Diesel	60-1051-c	\$4.99
Wood Burning (Hickory)	60-1051-d	\$4.99
Coffee	60-1051-e	\$4.99
Eggs & Bacon	60-1051-f	\$4.99
Vanilla	60-1051-g	\$4.99
Candy Cane	60-1051-h	\$4.99
Barbeque	60-1051-i	\$4.99
Pipe Smoke	60-1051-j	\$4.99
Cinnamon Roll	60-1051-k	\$4.99
Apple Pie	60-1051-l	\$4.99



- Boston Red Sox™ - #193 Industrial Water Tower 30-90144 \$54.95
Unit Measures: 6" x 6" x 14 3/4"



- New York Yankees™ - #193 Industrial Water Tower 30-90131 \$54.95
Unit Measures: 6" x 6" x 14 3/4"



- Pittsburgh Pirates™ - #193 Industrial Water Tower 30-90146 \$54.95
Unit Measures: 6" x 6" x 14 3/4"

Major League Baseball trademarks and copyrights are used with permission of Major League Baseball Properties, Inc. MLB.com M.T.H. Electric Trains / MLB 2006



- Harley-Davidson® - #193 Industrial Water Tower 30-90110 \$49.95
Unit Measures: 6" x 6" x 14 3/4"



© 2006 H-D, All Rights Reserved. Manufactured by M.T.H. Electric Trains under license from Harley-Davidson Motor Company. © 2006 M.T.H. Electric Trains, 7020 Columbia gateway Drive, Columbia, Maryland 21046

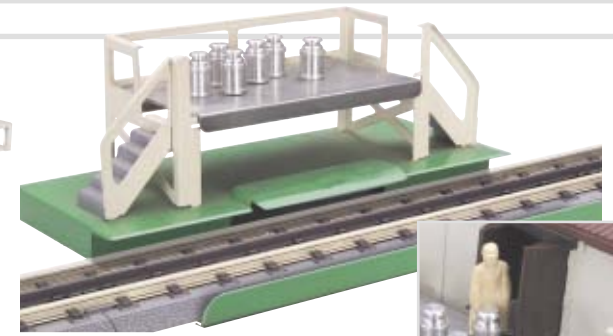

- Green - Milk Platform 30-9063 \$49.95
Unit Measures: 7 1/8" x 5 7/8" x 2 1/2"

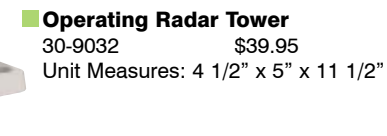

- Operating Radar Tower 30-9032 \$39.95
Unit Measures: 4 1/2" x 5" x 11 1/2"

BLINKING
OVERHEAD LIGHT



- Black - #153 Operating Block Signal 30-1076 \$29.95
Unit Measures: 9 1/8" Tall

- Green Base - #151 Operating Semaphore 30-1075 \$29.95
Unit Measures: 9 5/8" Tall



- Pea Green - #580-1 Teardrop Lamp Set 30-1079-a \$19.95
Unit Measures: 6 3/4" Tall

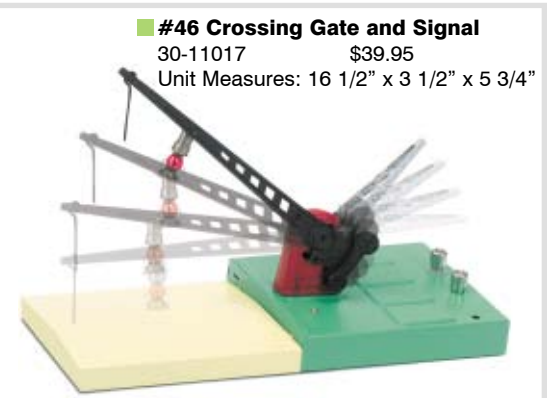

- #46 Crossing Gate and Signal 30-11017 \$39.95
Unit Measures: 16 1/2" x 3 1/2" x 5 3/4"



- #334 Operating Dispatch Board 30-9022 \$99.95
Unit Measures: 10 1/2" x 4 1/4" x 7 1/2"

TIMETABLE
AUTOMATICALLY FLIPS



- #395 Floodlight Tower 30-9049 \$39.95
Unit Measures: 5" x 5" x 11 1/4"



Baltimore & Ohio - 314 Die-Cast Girder Bridge
30-12004 \$29.95



Pennsylvania - 314 Die-Cast Girder Bridge
30-12001 \$24.95



Southern - 314 Die-Cast Girder Bridge
30-12007 \$29.95



Chicago NorthWestern - 314 Die-Cast Girder Bridge
30-12005 \$29.95



Reading - 314 Die-Cast Girder Bridge
30-12006 \$29.95



Road Sign Set (2 Each)
30-1087 \$14.95
Unit Measures: 2" Tall



Operating Traffic Light Set - Double Lamp
30-1089-2 \$24.95
Unit Measures: 5" Tall



O Scale Flashing Barricades (4)
30-11021 \$24.95
Unit Measures: 1" x 1" x 2"

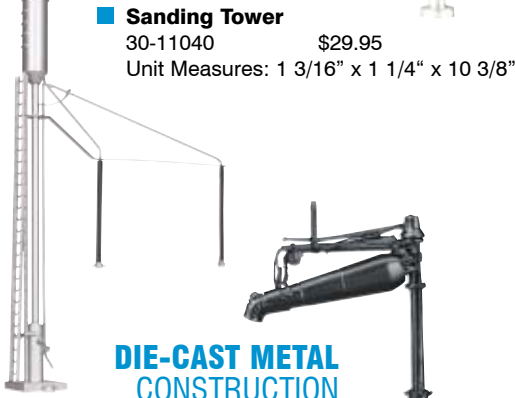

Sanding Tower
30-11040 \$29.95
Unit Measures: 1 3/16" x 1 1/4" x 10 3/8"



O Scale Pedestrian Crosswalk
30-9053 \$49.95
Measures: 11 5/8" x 13 3/8" x 7 7/8"



O Scale Pedestrian 2-Track Crosswalk
30-9066 \$59.95
Unit Measures: 16 1/8" x 13 3/8" x 7 7/8"



Roadster Hardtops - 32 Pack Vehicle Set
30-50031 \$159.95



Red - Die-Cast Fire Truck
30-50034 \$29.95
Unit Measures: 6 1/4" x 2 1/8" x 1 7/8"



Yellow - Die-Cast Fire Truck
30-50035 \$29.95
Unit Measures: 6 1/4" x 2 1/8" x 1 7/8"

PERFECT FOR O GAUGE LAYOUTS



Harley-Davidson® - 4-Pack Motorcycle Set
30-90126 \$19.95
Includes: (1) 2001 Dyna Low Rider®, (1) 2002 Fat Boy®, (1) 2002 1200cc Sporster®, (1) 2003 V-Rod®

Harley-Davidson® - 4-Pack Motorcycle Set
30-11077 \$19.95
Includes: (1) 2000 Dyna Super Glide®, (1) 2001 Springer Softail®, (1) 2001 Dyna Wide Glide®, (1) 2001 Road King®

© 2006 H-D. All Rights Reserved. Manufactured by M.T.H. Electric Trains under license from Harley-Davidson Motor Company. © 2006 M.T.H. Electric Trains, 7020 Columbia gateway Drive, Columbia, Maryland 21046

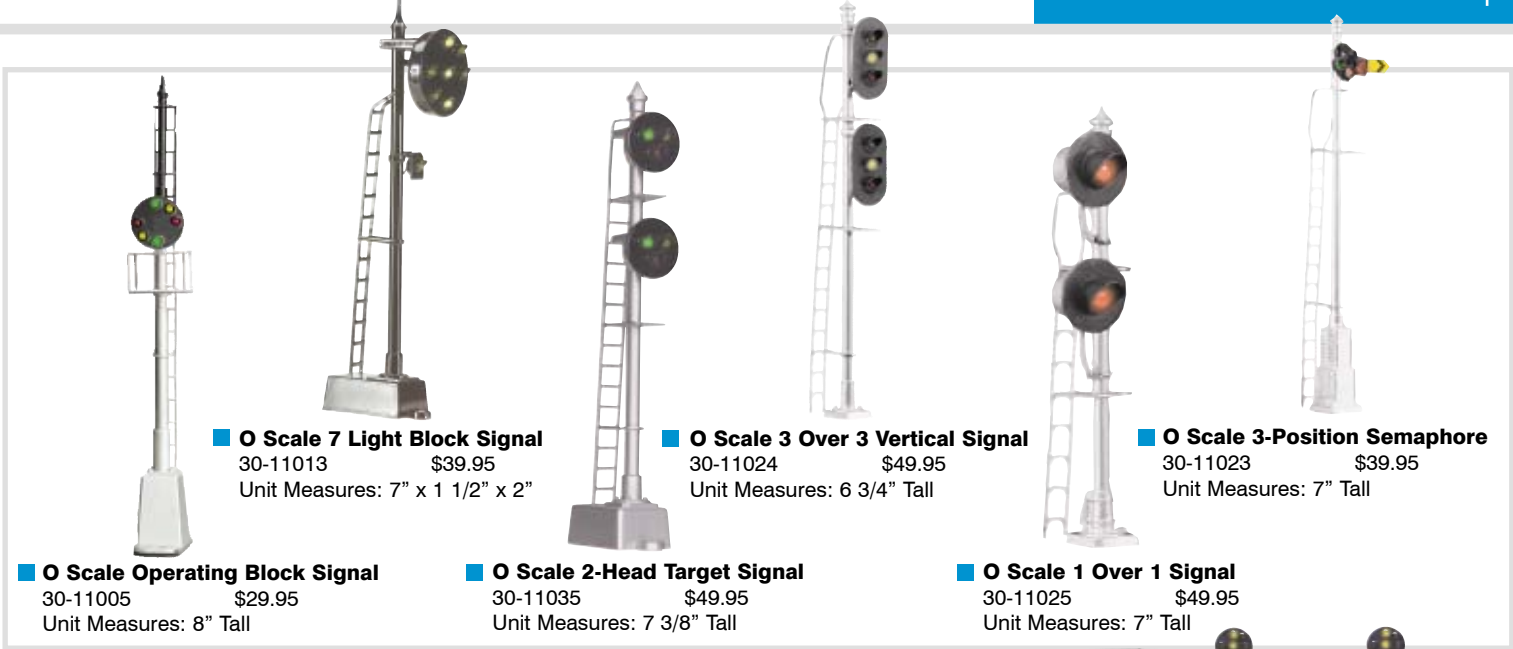

O Scale 7 Light Block Signal
30-11013 \$39.95
Unit Measures: 7" x 1 1/2" x 2"

O Scale 3 Over 3 Vertical Signal
30-11024 \$49.95
Unit Measures: 6 3/4" Tall

O Scale 3-Position Semaphore
30-11023 \$39.95
Unit Measures: 7" Tall

O Scale Operating Block Signal
30-11005 \$29.95
Unit Measures: 8" Tall

O Scale 2-Head Target Signal
30-11035 \$49.95
Unit Measures: 7 3/8" Tall

O Scale 1 Over 1 Signal
30-11025 \$49.95
Unit Measures: 7" Tall



O Scale Cantilevered Signal Bridge
30-11009 \$49.95
Unit Measures: 8 1/2" x 2 1/2" x 6 1/2"

METAL CONSTRUCTION

O Scale Operating Crossing Signal
30-11010 \$49.95
Unit Measures: 7 1/2" Tall

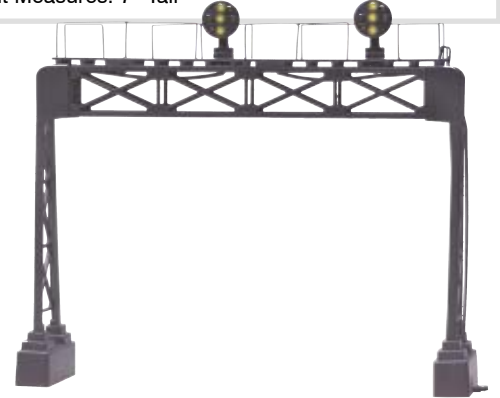

O Scale Pennsy Signal Bridge
30-11030 \$49.95
Unit Measures: 12 5/8" x 3 15/16" x 10 1/8"



O Scale Dwarf Signal
30-11011 \$24.95
Unit Measures: 1" x 1 7/8" x 1 3/4"

O Scale Modern Dwarf Signal
30-11038 \$24.95
Unit Measures: 1 1/2" x 1" x 2 1/8"



O Scale Operating Crossing Flasher Set w/Sound
30-11014 \$49.95
Unit Measures: 5 1/2" x 2 1/2" x 1"



O Lamp Set - Triple Park Light
30-11034 \$39.95
Unit Measures: 3/4" x 4 7/16"

O Lamp Set - Platform Light
30-11031 \$29.95
Unit Measures: 3/4" x 4 3/8"

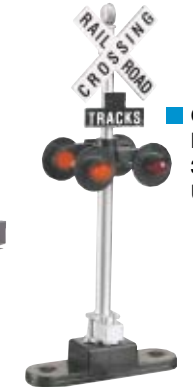

O-Scale Operating Crossing Gate Signal Set
30-11012 \$59.95
Unit Measures: 8 1/2" x 2" x 8"

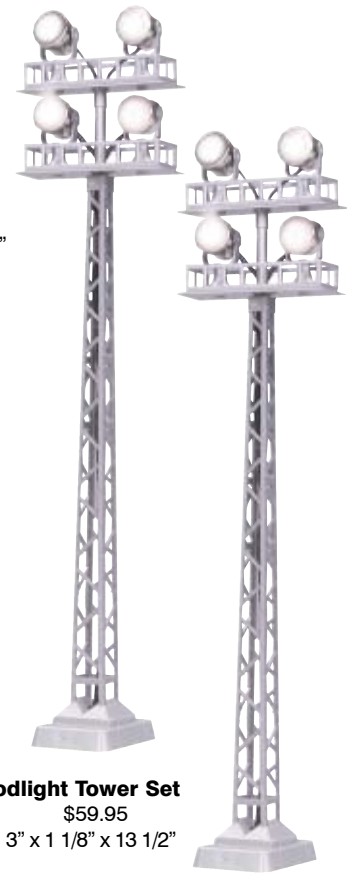

O Scale Floodlight Tower Set
30-11039 \$59.95
Unit Measures: 3" x 1 1/8" x 13 1/2"



Harley-Davidson® - Lighted Billboard
30-90128 \$29.95
Unit Measures: 7 1/2" x 5 3/4" x 6"

 © 2006 H-D, All Rights Reserved. Manufactured by M.T.H. Electric Trains under license from Harley-Davidson Motor Company. © 2006 M.T.H. Electric Trains, 7020 Columbia gateway Drive, Columbia, Maryland 21046



DCS- Lighted Billboard
30-90041 \$29.95
Unit Measures: 7 1/2" x 5 3/4" x 6"



Joe's Jumping Java - Lighted Billboard
30-90087 \$29.95
Unit Measures: 7 1/2" x 5 3/4" x 6"



Creamsicle - Lighted Billboard
30-90089 \$29.95
Unit Measures: 7 1/2" x 5 3/4" x 6"
Creamsicle and Popsicle is a registered trademark of Good Humor-Breyers. All rights reserved.



Popsicle - Lighted Billboard
30-90090 \$29.95
Unit Measures: 7 1/2" x 5 3/4" x 6"



Operating O Scale Water Tower
30-11028 \$79.95
Unit Measures: 7 1/2" x 11" x 10 1/4"



Bag Of Coal
30-50005 \$3.99



2-Piece Crate Set
30-50027 \$9.95



2-Piece Generator Set
30-50028 \$9.95



2-Piece Cement LCL Container Set
30-50029 \$14.95



8-Piece Pipe Set
30-50023 \$9.95



8-Piece Log Set
30-50008 \$14.95
Unit Measures: 5" Long



6-Piece Barrel Set
30-50024 \$9.95



I-Beam 8-Piece Set
30-50007 \$12.95
Unit Measures: 7 1/4" Long



2-Piece LCL Container Set
30-50030 \$14.95



Assortment 1 - 6-Piece Figure Set #12
30-11074 \$19.95



Assortment 1 - 6-Piece Figure Set
30-11071 \$19.95



Assortment 2 - 6-Piece Figure Set
30-11072 \$19.95



Assortment 2 - 6-Piece Figure Set #12
30-11075 \$19.95



Assortment 3 - 6-Piece Figure Set
30-11073 \$19.95



Miners - 6-Piece Figure Set #6
30-11058 \$19.95



Outdoor People - 6-Piece Figure Set
30-11057 \$19.95



8-Piece Locomotive Cab Figure Set
30-11064 \$29.95



Cops & Robbers - 6-Piece Figure Set #5
30-11056 \$19.95



Fire Scene - 6-Piece Figure Set #8
30-11060 \$19.95



Christmas - 6-Piece Figure Set
30-11062 \$24.95

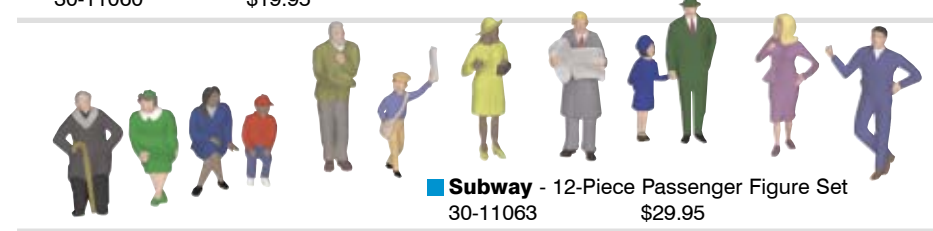

Subway - 12-Piece Passenger Figure Set
30-11063 \$29.95



Army/Navy - 10-Piece Figure Set
30-11065 \$29.95



Railroad Workman - 12-Piece Figure Set #3
30-11066 \$29.95



Army - 6-Piece Figure Set #7
30-11059 \$19.95



Undecorated - 120-Piece Passenger Figure Set
30-11043 \$29.95



Harley-Davidson® - 5-Piece Motorcycle Figure Set #1
30-11076 \$19.95

Mainline - Switch Tower
30-90177 \$49.95
Unit Measures: 6 1/8" x 10 1/2" x 9"



Use the remote control buttons to pick up coal with the clamshell bucket and load it into the building. Then dump the coal into a waiting car below.

A perfect companion for any hopper car, or our operating dump cars on pages 12 and 13!



Operating Coaling Tower
30-9158 \$149.95
Unit Measures: 9 1/2" x 8" x 12"

Pittsburgh Steelers - Switch Tower
30-90142 \$49.95
Unit Measures: 6 1/8" x 10 1/2" x 9"

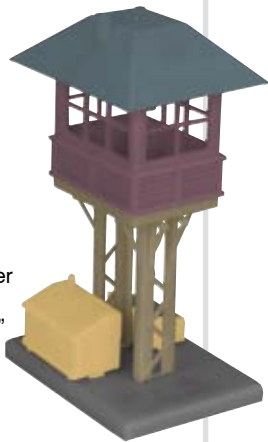

Brown & Black - Elevated Gate Tower
30-9097 \$24.95
Unit Measures: 3 1/2" x 2 1/2" x 5 3/4"



Gray & Maroon - Trackside Yard Tower
30-90006 \$29.95
Unit Measures: 4" x 4" x 7 1/2"



O Scale Yard Master Tower
30-11027 \$54.95
Conway Yards O Scale Yard Master Tower
30-90167 \$54.95
Unit Measures: 8 1/4" X 7 7/8" X 11 1/2"

White - Fence Set
30-50002 \$9.95
Unit Measures: 16" x 13"

HOUSE NOT INCLUDED



© 2006, NFL Enterprises LLC. NFL and the NFL shield design are registered trademarks of the National Football League. The team names, logos and uniform designs are registered trademarks of the teams indicated.

Santa Fe - Operating Watchman's Shanty
30-90203 \$59.95
Unit Measures: 4 1/2" x 5 15/16" x 4 1/8"



Each time a train approaches, the watchman rushes out of his shanty to stop traffic.



Navy Patrol - Operating Watchman's Shanty
30-9146 \$59.95
Unit Measures: 4 1/2" x 5 15/16" x 4 1/8"

Gray & Black - Operating Watchman's Shanty
30-9129 \$59.95
Unit Measures: 4 1/2" x 5 15/16" x 4 1/8"



Operating Station Platform
30-9152 \$49.95
Unit Measures: 10" x 3 1/2" x 4"

PASSENGERS & FREIGHT "DISAPPEAR"
SEE IT OPERATE, VISIT WWW.MTHTRAINS.COM



Military - Operating Station Platform
30-9145 \$49.95
Unit Measures: 10" x 3 1/2" x 4"



Pittsburgh Brewing Company - Operating Freight Platform
30-90189 \$49.95
Unit Measures: 10" x 3 1/2" x 4"

Perfect companions for the smoking breweries on page 52!



Altoona Brewing Co. - Operating Freight Platform
30-90191 \$49.95
Unit Measures: 10" x 3 1/2" x 4"



The Old Reading Brewing Company - Operating Freight Platform
30-90190 \$49.95
Unit Measures: 10" x 3 1/2" x 4"

Red - Passenger Station w/dual Platforms
30-9014 \$79.95
Unit Measures: 39" x 10 1/2" x 8 1/2"



Dark Red Stone - Passenger Station w/dual Platforms
30-90094 \$79.95
Unit Measures: 39" x 10 1/2" x 8 1/2"



Brown w/gray roof - Passenger Station Platform
30-9006 \$19.95
Unit Measures: 10" x 3 1/2" x 4"

RailTown - Country Passenger Station
30-9087 \$49.95
Unit Measures: 18 5/8" x 7 3/8" x 6 5/8"



Main Street - Country Passenger Station
30-90081 \$49.95
Unit Measures: 18 5/8" x 7 3/8" x 6 5/8"



ALL BUILDINGS FEATURE INTERIOR LIGHTING



Oak Grove - Country Passenger Station
30-90175 \$49.95
Unit Measures: 18 5/8" x 7 3/8" x 6 5/8"

ALL HOUSES & BUILDINGS FEATURE OPERATING INTERIOR LIGHTING



Stainless - Mobile Home
30-90005 \$29.95
Unit Measures: 7 1/8" x 2 3/8" x 2 3/4"



Gray & White - Out House
30-90001 \$12.95
Unit Measures: 1 3/16" x 1 5/16" x 2 7/16"

FIGURE NOT INCLUDED



Cream & Blue - Farm House #6
30-90179 \$34.95
Unit Measures: 7 1/2" x 7 1/2" x 7"



Turquoise & White - Mobile Home
30-90108 \$29.95
Unit Measures: 7 1/8" x 2 3/8" x 2 3/4"



Dark Cream - Farm House #6
30-90178 \$34.95
Unit Measures: 7 1/2" x 7 1/2" x 7"



Gray - Farm House #6
30-90054 \$34.95
Unit Measures: 7 1/2" x 7 1/2" x 7"

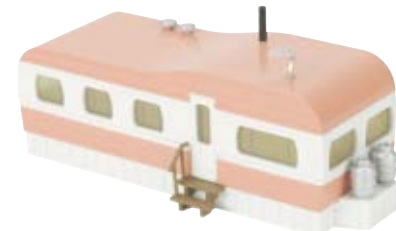

Salmon & White - Mobile Home
30-90109 \$29.95
Unit Measures: 7 1/8" x 2 3/8" x 2 3/4"



Mustard & Red - Work House #1
30-90008 \$29.95
Unit Measures: 8 5/8" x 4 7/16" x 4 7/8"



Weyerhaeuser Timber Co. - Logging Camp Bunk House
30-90138 \$34.95
Unit Measures: 9 1/4" x 6 1/8" x 5"



Blue & Black - Work House #1
30-90009 \$29.95
Unit Measures: 8 5/8" x 4 7/16" x 4 7/8"



Cream & Oxide - Work House #2
30-90011 \$29.95
Unit Measures: 8 5/8" x 4 7/16" x 4 7/8"



Union Timber Company - Logging Camp Bunk House
30-90137 \$34.95
Unit Measures: 9 1/4" x 6 1/8" x 5"



Gray & Black - Work House #2
30-90010 \$29.95
Unit Measures: 8 5/8" x 4 7/16" x 4 7/8"



Green & Brown - Row House #1
30-90180 \$29.95
Unit Measures: 8 1/2" x 4 5/8" x 7"



Blue & Tan - Row House #1
30-90181 \$29.95
Unit Measures: 8 1/2" x 4 5/8" x 7"



Cream & Red - Row House #2
30-90183 \$29.95
Unit Measures: 8 1/2" x 4 5/8" x 7"



Tan & Mojave - Row House #2
30-90182 \$29.95
Unit Measures: 8 1/2" x 4 5/8" x 7"



Yellow - Country House #4
30-9081 \$34.95
Unit Measures: 9 5/8" x 5" x 7"



Gray w/Blue Shutters - Country House #4
30-90156 \$34.95
Unit Measures: 9 5/8" x 5" x 7"



Mustard w/Black Shutters - Country House #4
30-90157 \$34.95
Unit Measures: 9 5/8" x 5" x 7"



Yellow - Country House #4
30-90186 \$34.95
Unit Measures: 9 5/8" x 5" x 7"



Cream & Gray - 3-Story Town House #2
30-9079 \$34.95



Blue & White - Telephone Shanty
30-90002 \$12.95



White & Red - Country Church #5
30-9057 \$29.95
Unit Measures: 7 7/8" x 4 5/8" x 10 9/16"



Tan - Country Church #5
30-90187 \$29.95
Unit Measures: 7 7/8" x 4 5/8" x 10 9/16"



Green - Country House #4
30-90185 \$34.95
Unit Measures: 9 5/8" x 5" x 7"





Altoona Brewing - Brewery w/Operating Smoke
30-90184 \$99.95
Unit Measures: 19 3/8" x 8 5/16" x 6 5/8"



Old Reading Brewing Co. - Brewery w/Operating Smoke
30-90133 \$99.95
Unit Measures: 19 3/8" x 8 5/16" x 6 5/8"

OPERATING SMOKE



Antique Shop - Road Side Stand
30-90096 \$39.95
Unit Measures: 8 1/2" x 5 7/16" x 4 1/4"



Red & Black - Country Freight Station
30-90004 \$39.95
Unit Measures: 9" x 5 1/2" x 5"



County Jail - Jail House
30-90014 \$29.95
Unit Measures: 4 1/4" x 4 1/8" x 3 7/8"



Salt Water Taffy Candy Shop - Road Side Stand
30-90097 \$39.95
Unit Measures: 8 1/2" x 5 7/16" x 4 1/4"



Cream & Dark Gray - Power Station
30-90003 \$29.95
Unit Measures: 4 1/4" x 4 1/8" x 3 7/8"



New York Central - Dry Goods Transfer Warehouse
30-90112 \$59.95
Unit Measures: 13 1/2" x 8 1/4" x 9 1/8"



Smith & Sons - Dry Goods Transfer Warehouse
30-90158 \$59.95
Unit Measures: 13 1/2" x 8 1/4" x 9 1/8"



Columbia Oil - Tank Filling Station
30-90099 \$49.95
Unit Measures: 16 1/8" x 5" x 8 1/8"



Orange - Yard Office
30-90013 \$39.95
Unit Measures: 11" x 6 11/16" x 3 3/8"

FLICKERING CAMPFIRE



Brown - Work Office
30-90012 \$39.95
Unit Measures: 11 1/2" x 3" x 4"

SLIDING DOORS & OPERATING INTERIOR LIGHTING

Muddy Creek Forks - Dry Goods Transfer Warehouse
30-90176 \$59.95
Unit Measures: 13 1/2" x 8 1/4" x 9 1/8"



Pennsylvania - Train Depot
30-90143 \$49.95
Unit Measures: 11 1/2" x 7 3/4" x 4 3/4"

New York Central - Train Depot
30-90160 \$49.95
Unit Measures: 11 1/2" x 7 3/4" x 4 3/4"



Red & White - Barn
30-90072 \$69.95
Unit Measures: 16 1/2" x 18 3/4" x 9 1/2"

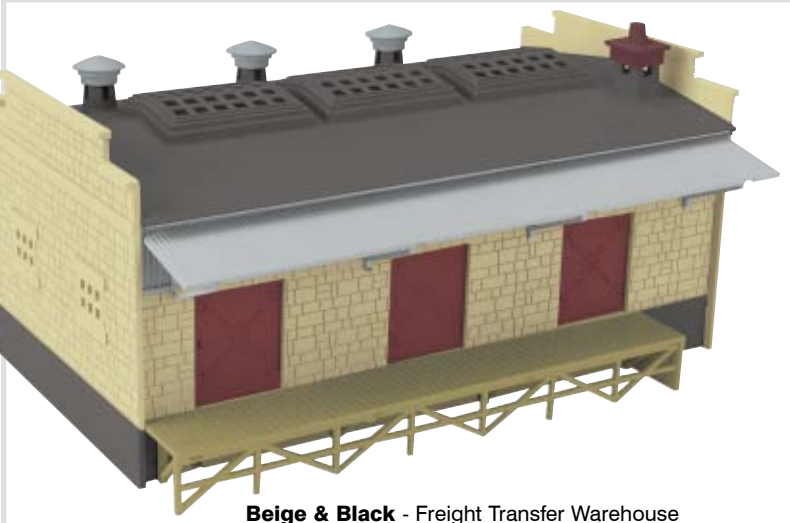

Beige & Black - Freight Transfer Warehouse
30-90098 \$79.95
Unit Measures: 13 3/16" x 8 3/4" x 6 3/16"



Gray Stone - Grainery
30-90188 \$59.95
Unit Measures: 10 1/4" x 7" x 11 1/8"



Watch the action and hear the sound effects as the the garage door rises and the car starts up, pulls out and fills up at the pumps. See it in operation at www.mthtrains.com

Sunoco - Operating Gas Station
30-9154 \$129.95
Unit Measures: 15" x 11" x 6 3/4"



Tippy's Tacos - Fast Food Restaurant Stand
30-90085 \$59.95
Unit Measures: 14 1/2" x 12" x 7 1/2"



Burger Chef - Fast Food Restaurant Stand
30-90084 \$59.95
Unit Measures: 14 1/2" x 12" x 7 1/2"

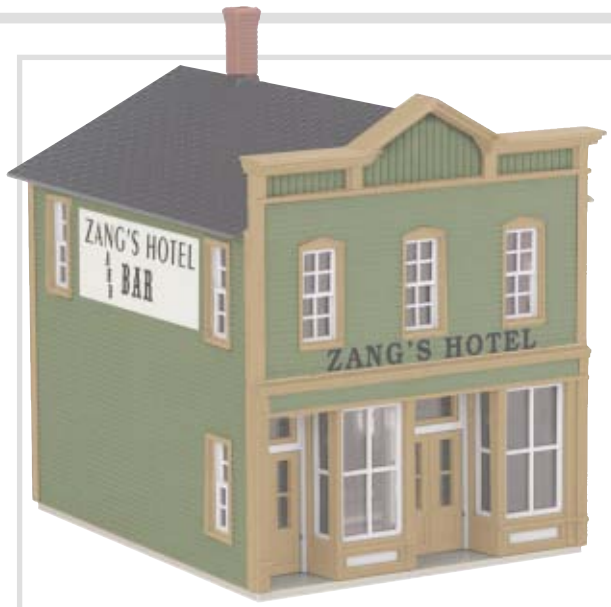

Zang's Hotel - 2-Story Hotel Building
30-90162 \$39.95
Unit Measures: 6 1/2" x 8" x 8 5/8"



D&RG Railway Express - 2-Story Livery Building
30-90163 \$39.95
Unit Measures: 6 1/2" x 8" x 8 5/8"



S&D Dry Goods and Provisions - 2-Story Store Front Building
30-90164 \$39.95
Unit Measures: 6 1/2" x 8" x 8 5/8"

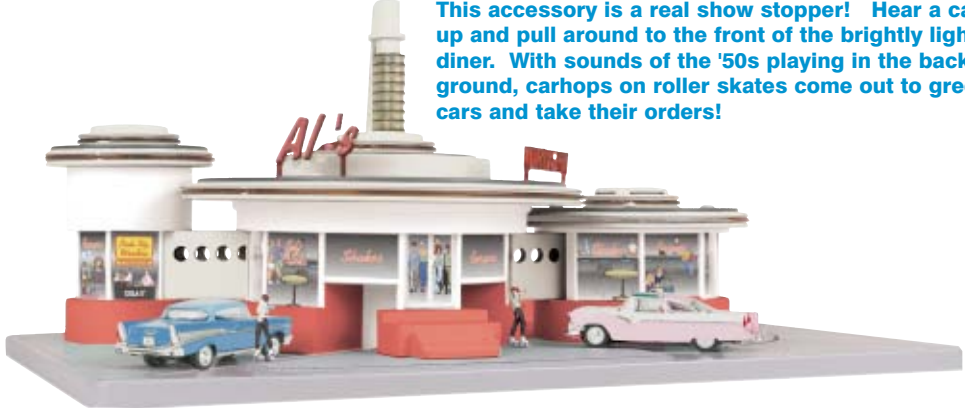

This accessory is a real show stopper! Hear a car start up and pull around to the front of the brightly lighted diner. With sounds of the '50s playing in the background, carhops on roller skates come out to greet both cars and take their orders!

Al's - Operating Drive-In Diner
30-9148 \$179.95
Unit Measures: 21 5/8" x 9" x 13 1/8"



McDonald's® - Original
30-9034 \$59.95
Unit Measures: 14 1/2" x 12" x 7 1/2"



Lil Jenny's Grocery - Grocery Store
30-90200 \$59.95
Unit Measures: 9 3/8" x 9 3/8" x 6 3/8"



Caterpillar® - The Rental Store
30-90127 \$59.95
Unit Measures: 9 3/8" x 9 3/8" x 6 3/8"



John Deere - Tractor Dealership
30-90145 \$59.95
Unit Measures: 9 3/8" x 9 3/8" x 6 3/8"
John Deere is a registered trademark of Deere & Company.

© 2006 Caterpillar
CAT, Caterpillar, their respective logos, Caterpillar Yellow, other marks and corporate identity used herein are trademarks of Caterpillar, and may not be used without permission. Third party trademarks are the property of their respective owners.



Curley Pretzels - Concession Stand
30-90202 \$39.95
Unit Measures: 10 7/8" x 4 1/2" x 7 5/8"



Horse Shoe Curve Eats - Concession Stand
30-90201 \$39.95
Unit Measures: 10 7/8" x 4 1/2" x 7 5/8"



Miller & Sons Furniture - Department Store
30-90025 \$49.95
Unit Measures: 9 3/8" x 9 3/8" x 6 3/8"



Smith Brothers - Automobile Dealership
30-90021 \$49.95
Unit Measures: 9 3/8" x 9 3/8" x 6 3/8"



Harley-Davidson® - Motorcycle Dealership
30-90111 \$59.95
Unit Measures: 9 3/8" x 9 3/8" x 6 3/8"

HARLEY-DAVIDSON
© 2006 H-D, All Rights Reserved.
Manufactured by M.T.H. Electric Trains under license from Harley-Davidson Motor Company.
© 2006 M.T.H. Electric Trains, 7020 Columbia Gateway Drive, Columbia, Maryland 21046



Gray & Black - Police Station
30-9099 \$59.95
Unit Measures: 13 1/4" x 8 3/8" x 10"



Gray & White - Public Works Building
30-90007 \$79.95
Unit Measures: 14 1/8" x 9 7/8" x 8 1/8"



Bavarian Garden Works - 4-Story Building
30-90192 \$49.95
Unit Measures: 10 7/8" x 8 5/8" x 8 7/8"



Melissa's House of Costumes -
4-Story Building
30-90172 \$49.95
Unit Measures: 10 7/8" x 8 5/8" x 8 7/8"



Old Line Flag Company - 4-Story Building
30-90193 \$49.95
Unit Measures: 10 7/8" x 8 5/8" x 8 7/8"

**BUILDINGS HAVE
OPERATING
INTERIOR LIGHTING**



Bowhunter's Corner -
Corner Building w/Blinking Sign
30-90173 \$49.95
Unit Measures: 9 7/8" x 7 7/16" x 7 1/16"

**INCLUDES
BLINKING STORE
WINDOW SIGN**

Pennsylvania Ticket Office -
Opposite Corner Building w/Blinking Sign
30-90159 \$49.95
Unit Measures: 9 7/8" x 7 7/16" x 7 1/16"



Sal's Philly Cheese Steaks -
Corner Building w/Blinking Sign
30-90174 \$49.95
Unit Measures: 9 7/8" x 7 7/16" x 7 1/16"



Lombardi's Pizza - 3-Story City Building
30-90019 \$39.95
Unit Measures: 6 5/8" x 9 1/2" x 8 3/4"



Katz's Deli - 3-Story City Building
30-90020 \$39.95
Unit Measures: 6 5/8" x 9 1/2" x 8 3/4"



The Brunswick -
6-Story Building
30-90016 \$59.95
Unit Measures: 8 7/8" x 8 5/8" x 15 5/8"



5-Story Flower Shop w/Blinking Sign
30-90122 \$69.95
Unit Measures: 6 1/2" x 9 1/2" x 13 1/2"



3-Story Pet Store w/Blinking Sign
30-90121 \$49.95
Unit Measures: 12 3/4" X 6 5/16" X 9"

INCLUDES
**BLINKING STORE
WINDOW SIGN**



Dewey, Cheetum & Howe - 3-Story City Building w/Fire Escape & Blinking Sign
30-90154 \$59.95
Unit Measures: 12 3/4" x 6 5/16" x 9 3/16"



Hubie Skriemen D.D.S. - 3-Story City Building w/Fire Escape & Blinking Sign
30-90155 \$59.95
Unit Measures: 12 3/4" x 6 5/16" x 9 3/16"



Cadwalladers Welsh Tavern - 3-Story City Building w/Fire Escape & Blinking Sign
30-90194 \$59.95
Unit Measures: 12 3/4" x 6 5/16" x 9 3/16"



Lost Sock Laundromat - 3-Story City Building w/Fire Escape & Blinking Sign
30-90196 \$59.95
Unit Measures: 12 3/4" x 6 5/16" x 9 3/16"

Rizzotto Brothers Exterminators - 3-Story City Building w/Fire Escape & Blinking Sign
30-90195 \$59.95
Unit Measures: 12 3/4" x 6 5/16" x 9 3/16"



Cadwalladers Welsh Tavern - City Building w/Fire Escape Single Story Addition
30-90204 \$24.95
Unit Measures: 12 3/4" x 6 5/16" x 2 1/2"



O'Mara's Irish Pub - City Building w/Fire Escape Single Story Addition
30-90197 \$24.95
Unit Measures: 12 3/4" x 6 5/16" x 2 1/2"



Jahn's Ice Cream - City Building w/Fire Escape Single Story Addition
30-90199 \$24.95
Unit Measures: 12 3/4" x 6 5/16" x 2 1/2"



Lost Sock Laundromat - City Building w/Fire Escape Single Story Addition
30-90206 \$24.95
Unit Measures: 12 3/4" x 6 5/16" x 2 1/2"



Rizzotto Brothers Exterminators - City Building w/Fire Escape Single Story Addition
30-90205 \$24.95
Unit Measures: 12 3/4" x 6 5/16" x 2 1/2"



M.T.H. Train Store - City Building w/Fire Escape Single Story Addition
30-90198 \$24.95
Unit Measures: 12 3/4" x 6 5/16" x 2 1/2"

EXPAND
THE ABOVE BUILDINGS
WITH ADD-ON ADDITIONS



Christmas Store - Weathered Opposite Corner Building w/Blinking Sign
30-90104 \$74.95
Unit Measures: 9 7/8" x 7 7/16" x 7 1/16"

**CITY-STAINED
SIDEWALKS**



**GRIME-STAINED
ROOF DETAIL**



Gray & White - Weathered Public Works Building
30-90105 \$99.95
Unit Measures: 14 1/8" x 9 7/8" x 8 1/8"



**SIDING AND BASE DETAIL
COMES TO LIFE**



Weathered Country Passenger Station
30-90103 \$79.95
Unit Measures: 18 5/8" x 7 3/8" x 6 5/8"

RailTown Signature Series

RailTown buildings have long been acclaimed for their ease of use, variety and scale details. Pre-assembled and painted, each is ready-to-use right out of the box.

Now, for those looking for a prototypical scale layout, M.T.H. is pleased to offer our all-new RailTown Signature Series buildings that are pre-weathered for an incredibly realistic appearance. Created in partnership with Scale Models, Arts & Technologies, Inc. (SMARTT), each building's distinctive paint scheme was originally designed and crafted by an artist who specializes in creating structures for SMARTT's custom layouts built for private and corporate clients nationwide.

Intricate details like brick mortar, weathered roof lines and sun bleached siding helps make RailTown Signature Series buildings look even more realistic, adding an incredible touch of realism to your model railroad.

Look for an exciting coupon offer from SMARTT in every MTH Signature Series building!

SEE THEM IN ACTION
VISIT WWW.MTHTRAINS.COM



**SOOT-COVERED
WALKWAY**

Tank lid lowers and raises as tank is "filled or drained".



**DIRTY STEPS &
STAINED INNER
TANK WALLS**

Watch as walkway lowers to fill tank car!



Shell - Weathered Operating Storage Tank Station
30-9150 \$199.95
Unit Measures: 16 1/8" x 5" x 8 1/8"

**GRIMY
CEMENT BASE**



Shell - Weathered Operating Storage Tank
30-9149 \$199.95
Unit Measures: 17 5/16" x 11" x 10"

As a siren wails and lights flash, watch the fireman slide down the pole, the engine house door open, and the fire truck race off to the fire!



Engine Company 49 - Operating Firehouse
30-9157 \$149.95
Unit Measures: 16 5/8" x 15 3/8" x 12 3/8"



Fire Company 219 - Operating Firehouse
30-9159 \$149.95
Unit Measures: 16 5/8" x 15 3/8" x 12 3/8"



OPERATING BUILDINGS

Red/Black - 3-Story Town House On Fire
30-9155 \$129.95
Unit Measures: 6 3/8" x 3 15/16" x 7 1/8"



White w/Blue Shutters - House On Fire
30-9153 \$129.95
Unit Measures: 7 1/2" x 7 1/2" x 7"



Internal Revenue Service - 3-Story City Building On Fire
30-9156 \$129.95
Unit Measures: 12 3/4" x 6 5/16" x 9 3/16"

Fireman squirts real water on flickering "flames" as smoke billows from building.



OPERATING McDONALDS®

Recreate one of America's most popular modern-day restaurants with this unique and fun to operate accessory.

Fully assembled and painted, the accessory hooks up in minutes to any AC transformer. Activation occurs with just a touch of a button at which point the included SUV begins circling the structure stopping first to place an order and then a second time to pick-up the food. Audio features include the sounds of different customers ordering for a sense of variety and background car radio music for an added touch of realism.

FEATURES:

- ABS Construction
- Fully Assembled & Painted
- Interior Illumination
- Automatic Operation & Digital Sound Effects
- Die-Cast 1/43 Scale SUV Included
- Unit Measures: 17" x 17" x 7 3/4"



McDonalds® - Operating
30-9114 \$179.95
Unit Measures: 17" x 17" x 7 3/4"



OPERATING TRANSFER DOCK

Operating Transfer Dock
30-9110 \$179.95
Unit Measures: 18 7/8" x 10 3/16" x 9 3/4"

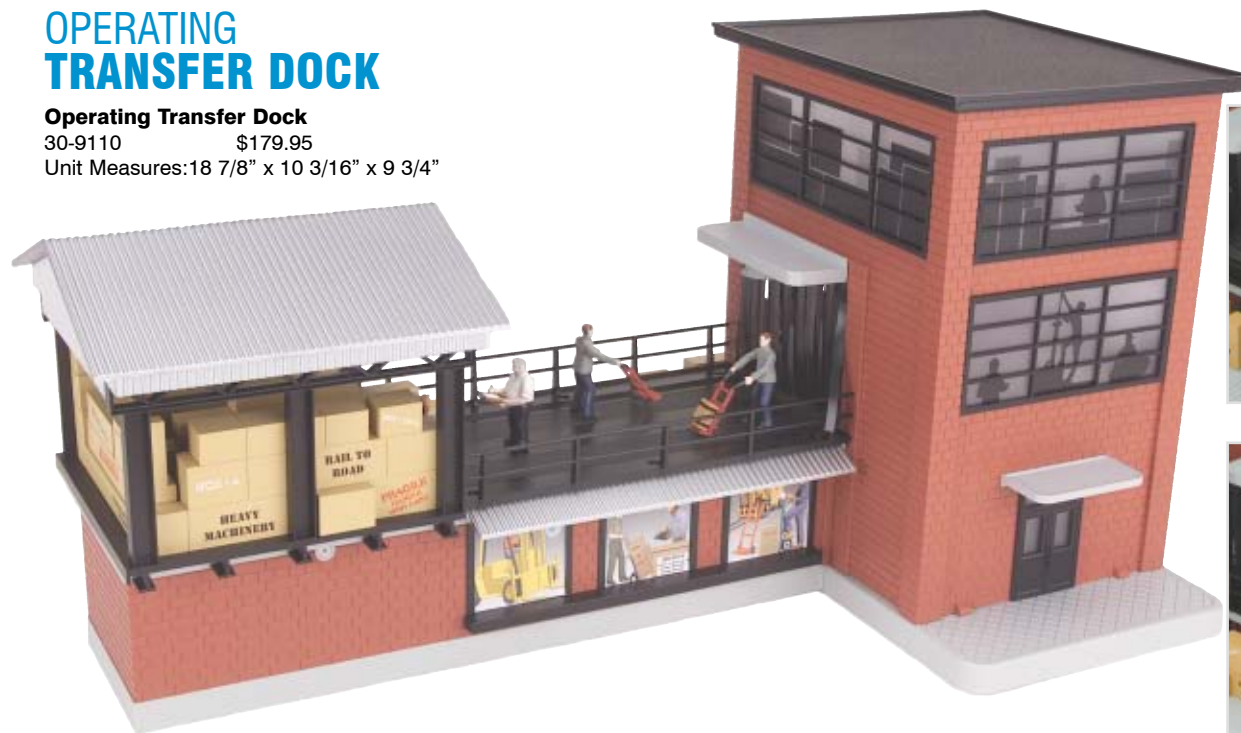

Moving freight is what most of today's railroading is all about. The new MTH RailKing Transfer Dock is the perfect accessory to showcase your layout's freight activity.

This attractively detailed, ABS structure features a truck loading dock and elevated rail platform perfect for simulating freight movement between tractor trailer and rail car. There's lots of activity on this dock thanks to the moving dock workers who tirelessly hand truck their freight from platform to warehouse. Featuring near-silent operation and realistic movement, this fully functioning accessory comes completely assembled, painted and decorated for right-out-of-the-box use.

FEATURES:

- Intricately Detailed ABS Construction
- Fully Assembled
- Fully Painted
- Lighted Interior
- Operating Dock Workers Move Freight
- Unit Measures: 18 7/8" x 10 3/16" x 9 3/4"



JOIN THE CLUB

There are SIX different types of memberships, based on the style of model railroading that most interests you.

JOIN ONLINE! IT'S EASY - JUST GO TO WWW.MTHTRAINS.COM

RailKing Membership



30-74347 2006 MTHRRC High Cube Box Car
RailKing Membership is \$50.00

Premier Membership



20-94117 2006 MTHRRC PA R50B Reefer Car
Premier Membership is \$50.00

Standard Gauge Tinplate Membership 200 Series



10-2156 2006 MTHRRC 200 Series Searchlight Car
Tinplate 200 Series Membership is \$120.00

O Gauge Tinplate Membership 2800 Series



10-8022 2006 MTHRRC 2800 Series O Gauge Box Car
Tinplate 2800 Series Membership is \$80.00

One-Gauge Membership



70-76040 2006 MTHRRC Flat Car with 45' Trailer
One-Gauge Membership is \$100.00

Basic Club Membership

60-1000 - The Basic Club Membership does not include a club car
Basic Membership is \$25.00



AS A MEMBER OF THE M.T.H. RAILROADERS CLUB YOU'LL RECEIVE:

Limited-Edition Club Car



Each year we produce beautifully decorated cars exclusively for our Club members. Members automatically receive the car that matches their Club membership (RailKing®, Premier, Tinplate Traditions™ or One Gauge) & have the option to collect the other Club cars as well.

RailWare™ Software CD-ROM



Use your computer to design track layouts, search the database of all M.T.H. products, look at our past catalogs, listen to Proto-Sound® 2.0 train effects, & much more. This CD retails for \$79.95, but is yours FREE as a Club member.

The CrossingGate™ Club Magazine



You will receive our full color Club magazines, jam-packed with product news, ideas from other members, rail history, & step-by-step articles explaining how M.T.H. technology can bring your railroad to life.

Club Card & Lapel Pin



Show the world your membership in this elite group of model railroaders with your high-quality embossed membership card & beautiful enamel lapel pin.

1st Class Mailing of M.T.H. Catalogs

Club Members get all of our catalogs earlier than all our other mailing list members via First-Class mailings, so they can order from their local train store before the best items are sold out.

Proto-Sound® 2.0 Upgrade Kits

Club members can save an additional 15% on these kits by visiting the MTHRRC web page.



Club Web Site

Visit WWW.MTHTRAINS.COM & type in your member number to gain access to the Club web site. Here you can exchange messages with other Club members, keep up with the latest news, & even build your own homepage.

CARRY ON THE M.T.H. TRADITION WITH MEMORABILIA AND COLLECTIBLES

MTH Promotional DVD



This interactive DVD is packed full of sights & sounds guaranteed to make you rethink how far the hobby of model railroading has come. You'll learn about some of the most innovative products ever produced & marvel at the sophistication of a product line unmatched by other model train manufacturers.



Previous Year Club Cars

MTHRRC members can still obtain earlier produced MTHRRC cars by visiting the MTHRRC pages on the website. Only MTHRRC members can get these cars!

A Toy Train Story

This comprehensive book is a must for collectors & other lovers of toy trains. 350 pages & 1900 color photos, hard cover. Add this book to your membership for only \$25.00 (50% off the \$49.95 cover price)!



GET THE MOST FROM MODEL RAILROADING

On-line access to the network of M.T.H. Authorized Retailers and "tools" on the M.T.H. website (www.mth-railking.com), such as the M.T.H. Product Locator, have helped many train enthusiasts locate nearby retailers, service centers or even a particular desired product for years.

Now, M.T.H.'s new on-line "Dealer Availability" finder allows customers interested in a newly-announced product to find a retailer with the item(s) on order.

In addition, M.T.H. is expanding these services with two ALL NEW programs that will provide consumers with access to retailers who provide a superior environment for showcasing and demonstrating M.T.H. products and cutting edge technology:

1. At M.T.H. Authorized DCS Demo Centers, you can now expect to see DCS and Proto-Sound® 2.0 equipped locomotives in action, find DCS in stock and learn more about this exciting command control system from experienced DCS staff members.

2. M.T.H. Authorized Mega Station Retailers are your best bet for finding the widest selection of M.T.H. products in stock when you want them. Like a DCS Demo Center, your local Mega Station retailer has DCS in stock and the know-how to get you up and running in no time.

You will find a list of DCS Demo Centers and Mega Stations on the M.T.H. website. In addition, anytime you do a search for a local retailer or a product using the Dealer and Product Locator search tools, M.T.H. Authorized Retailers who meet the DCS Demo Center and Mega Station requirements will be identified with the appropriate icons.

Even if your local retailer hasn't yet qualified for either of these new programs, any M.T.H. Authorized Retailer has the ability to determine what is in stock and can place an order for merchandise 24 hours per day. Look for any of the M.T.H. Authorized Retailer symbols (left) the next time you visit a toy train store and see the "Fun in Action!"

Not all products depicted in this catalog are production models. In some cases, the items pictured may be HO, O Scale or some other scale product. All item's graphic features and content are subject to change after publication. All product features may be verified on their retail packages. M.T.H. Electric Trains is in no way affiliated with any of the railroads featured in this catalog.

©2006, M.T.H. Electric Trains, 7020 Columbia Gateway Drive, Columbia Maryland 21046-1532 o www.mthtrains.com o 410-381-2580

MTH Trademarks: M.T.H. Electric Trains®, M.T.H.®, MTH Railroaders Club™, Ives®, Loco-Sound™, Proto-Sound® 2.0, Proto-Speed Control™, Proto-Doppler™, Proto-Dispatch™, Proto-Cast™, ProtoSmoke™, Proto-Coupler™, Proto-Effects™, RailKing®, Rugged Rails®, RailKing One-Gauge™, RailTown™, Tinplate Traditions®, ScaleTrax™, RealTrax®, Z-500™, Z-750™, Z-4000®, Z-1000™, Z-4000 Remote Commander™, DCS™ and the MTH Numbering System and all others indicated throughout this catalog. RealTrax® layouts created with RR-Track™ which is a registered trademark of R&S Enterprises.

RAILKING O GAUGE MEGASTATIONS

CALIFORNIA

WESTERN DEPOT
Phone: (530) 673-6776
info@westerndepot.com

DELAWARE

JUST TRAINS
Phone: (888) 453-9742
kirkm@justtrains.com

FLORIDA

READY TO ROLL
Phone: 305-688-8868
rttrains@aol.com

ROUNDHOUSE SOUTH
Phone: 386-304-7002
info@roundhousesouth.com

ILLINOIS

BERWYN'S TOY TRAINS
(708) 484-4384
berwynstoytrains@comcast.net

HILLS HOBBY & COLLECTORS
SHOP
Phone: (847) 823 - 4464
trains@hillshobby.com

INDIANA

RUPEL TOY TRAINS
Phone: (574) 875-8008
rexrepc@verizon.net

IOWA

CABOOSE STOP HOBBIES
Phone: (800) 642-7012
trainguy34@mchsi.com

MASSACHUSETTS

NORTHEAST TRAINS
Phone: 978-532-1615
netrains@netrains.com

Cat, Caterpillar, their respective logos, Caterpillar Yellow, other marks and corporate identity used herein are trademarks of Caterpillar and may not be used without permission. Third-party trademarks are the property of their respective owners.

John Deere is a registered trademark of Deere & Company

Major League Baseball trademarks and copyrights are used with permission of Major League Baseball Properties, Inc. MLB.com MTH Trains/MLBP 2006

©2006, NFL Enterprises LLC. NFL and the NFL Shield design are registered trademarks of the National Football League. The team names, logos and uniform designs are registered trademarks of the teams indicated.

Popsicle, Klondike, Good Humor are registered trademarks of Good Humor-Breyers

© 2006 H-D. All Rights Reserved. Manufactured by M.T.H. Electric Trains under license from Harley-Davidson Motor Company.

MARYLAND

CATOCTIN MTN. TRAINS &
HOBBIES
Phone: 301-694-8331
trainspj@aol.com

ENGINE HOUSE HOBBIES
Phone: 301-590-0816
luciecerise@aol.com

SIDETRACK HOBBIES
Phone: 301-475-5381
arudman@erols.com

NEVADA

RENO RAILS
Phone: 775-337-6669
renorails@renorails.com

NEW JERSEY

THE HOBBY SHOP
Phone: 732-583-0505
sales@hobbyshopnj.com

NEW YORK

TRAIN WORLD
Phone: 718-436-7072
orders@trainworld.com

TRAIN LAND
Phone: (516) 599-7080
trainlife@aol.com

SCAG'S ELECTRIC TRAINS
Phone: (718) 727-7373
patscags@msn.com

NORTH CAROLINA

THE TRAIN LOFT
Phone: (877) 550-6019
JKonc52032@aol.com

OHIO

DAVIS TRAINS
Phone: (800) 448-1060
davistrains@fuse.net

DIXIE UNION STATION
Phone: 513-459-0460
rockylane@core.com

PENNSYLVANIA

NICHOLAS SMITH TRAINS
Phone: 610-353-8585
mth@nstrains.com

CHOO CHOO BARN
Phone: (717) 687-0464
trainshop@choochoobarn.com

JIM'S TRAIN SHOP
Phone: 724-479-2026
sudsy@adelphia.net

BUSSINGER TRAINS
Phone: (215) 628-2366
choochoos@icdc.com

BRADY'S TOY TRAINS
Phone: (724) 838-8448
jbradytrains@earthlink.net

IMPERIAL TRAIN COMPANY
Phone: (724) 695-7552
info@imperialtrainco.com

VALLEY FARM MARKET
Phone: (814) 787-8911
valleyfarmmarket@alltel.net

WASHINGTON

EASTSIDE TRAINS
Phone: (425) 828-4098
eastsidetrains@msn.com

WEST VIRGINIA

PATRICK'S TRAINS
Phone: (304) 232-0714
patstrains@aol.com

Rudolph the Red-Nosed Reindeer © and ® The Rudolph Company, L.P. "Rudolph the Red-Nosed Reindeer" animated program © Classic Media, Inc. All rights reserved. © 2006 Anheuser-Busch, Inc. All Rights Reserved."

TMCC®, TrainMaster®, CAB-1® Remote Controller, and Lionel® are all registered trademarks owned by Lionel L.L.C. All Rights Reserved.

M.T.H.'s DCS Digital Command System has received U.S. Patent No. 6,457,681. M.T.H.'s Proto-Sound 2.0 system has received U.S. Patent No's 6,457,681 B1 (sound system), 6,457,681 B1 (Proto-Speed Control), 6,604,641 (Proto-Coupler), 6,280,278 (Proto-Snake).

M.T.H.'s RealTrax has received U.S. Patent No. 6,019,289. M.T.H.'s ScaleTrax switches has received U.S. Patent No. 6,491,263.

M.T.H.'s Z-4000 Transformer has received U.S. Patent No's 6,281,606 & 6,624,537.

M.T.H.'s Proto-Scale 3-2 has received U.S. Patent No. 6,662,917. Some images used in this publication © 2004 www.clipart.com

A quick trip to the M.T.H. website will result in a wealth of information on M.T.H. products from a site that was designed to give the visitor easy access to all things M.T.H. Here you will find a complete list of M.T.H. products, an easy-to-use product locator, and tons of news and information on M.T.H. You can even watch videos of M.T.H. products in action!

SERVICE INFO

Our Service Page is your direct link to the M.T.H. Tech Support Team. Register your warranty, find a local service center or submit a product specific question here. You can even place a parts order through our secured server. It's easy and quick like it should be when you're looking for answers.

PRODUCT LOCATOR

The most popular section of the M.T.H. website can be found here. This is where visitors come looking to locate a particular product within the vast M.T.H. Authorized Retailer network. Developed in 1999, no other manufacturer has yet created a service like this for their customers. With over 7,000 items in the M.T.H. product line, this tool is your best bet for finding a hard-to-get M.T.H. item.

VIEW A CATALOG

The latest products featured in each M.T.H. catalog can be seen here. This is a popular destination for customers waiting for a new catalog to arrive in the mail. Sign up for our free electronic newsletter and you'll be notified when a new catalog has been posted online. You'll have all the news and details before any of your friends.

SHIPPING SCHEDULE

Keeping track of all those M.T.H. items would be an impossible task without our online shipping schedule. We update the schedule every week with the latest monthly releases. You can access this information directly or from the Product Locator section.

M.T.H. HOMEPAGE FIND IT HERE

HOME | ABOUT US | OUR TECHNOLOGY | NEWS HEADLINES | BUSINESS OPPORTUNITIES | REGIONAL LINKS | CONTACT US | MY MTH

Product Keyword Search:

- Shopping
- Catalogs
- Shows
- Club Info
- Service
- Shipping
- Video
- Product Locator

Premier Line Erie Built Diesel Locomotives Arrive

Best-in-Class Variety, Outstanding Value | Digital Sound, Unmatched Quality | Four-Motor Power, Operating Brakes | Proto-Sound 2.0 Speed Control

M.T.H.'s Premier Line Erie-Built Diesel Locomotive Sets have begun shipping to M.T.H. Authorized Retailers. Click here to learn more!

New GG-1 Electrics Arrive!

MORE NEWS

Use buttons to learn more about MTH

RAILKING | MTH | REALTRAX | SCALETRAX | PRO-SOUND

Place Your Model Railroad Website

Now you can receive our newsletter FREE!

Sign Me Up!

Enter email address

Upon sign-up you will receive weekly newsletters featuring new products, recent articles, industry news plus sneak peaks at upcoming specials!

Privacy Policy | Close Window | Don't Show this Again

FREE ELECTRONIC NEWSLETTER

Upon sign-up you will receive electronic newsletters featuring information on new M.T.H. products, industry news plus sneak peaks at upcoming specials! It's the best way to stay abreast of the latest happenings at M.T.H. Electric Trains.

WWW.MTHTRAINS.COM



DCS™...SIMPLY THE BEST WAY TO RUN A RAILROAD

DETAILS ON PAGE 36

JUST TRY IT AT YOUR LOCAL **DCS DEMO CENTER** OR LEARN MORE WITH A **COMPLIMENTARY DVD** ON DCS AND M.T.H. TECHNOLOGY



Take your favorite Proto-Sound® 2.0 locomotive to any demo center and experience the additional features your engine has with DCS™ control.

TO FIND YOUR NEAREST DCS DEMO CENTER OR REQUEST YOUR COMPLEMENTARY DVD VISIT **WWW.MTHTRAINS.COM**

