



ACCESSORY INTERFACE UNIT

OPERATOR'S MANUAL

Compatibility

This device is compatible with any model railroading accessory or switch activated by an external power supply or control switch. Consult the individual item's operator's manual for specific instructions on how to operate the accessory or switch.

PLEASE READ BEFORE USE AND SAVE

Table of Contents

Introduction To The AIU	3
Required Tools.....	3
Installing The AIU Into The DCS System	4
Wiring To The TIU.....	4
Daisy Chaining AIUs Together.....	4
Programming AIUs Into The DCS System	5
Wiring Accessories And Switches	6
Operating Track Section.....	6
Switches And Turnouts.....	7
Accessories With Two Contacts.....	8
Accessories With Three Contacts.....	9
Accessories With Four Contacts.....	10
Accessories With Five Contacts.....	11
Programming Individual Accessories And Switches Into The DCS System	12
Programming Accessories.....	12
Programming Switches.....	15
Activating Accessories And Switches	17
Troubleshooting AIU Problems	19
Service & Warranty Information	20
Limited One-Year Warranty.....	20

CAUTION: ELECTRICALLY OPERATED PRODUCT

Recommended for Ages 14 and up. Not recommended for children under 14 years of age without adult supervision. As with all electric products, precautions should be observed during handling and use to prevent electric shock.

WARNING: When using electrical products, basic safety precautions should be observed, including the following:
Read this manual thoroughly before using this device.

M.T.H. recommends that all users and persons supervising use examine the hobby transformer and other electronic equipment periodically for conditions that may result in the risk of fire, electric shock, or injury to persons, such as damage to the primary cord, plug blades, housing, output jacks or other parts. In the event such conditions exist, the train set should not be used until properly repaired.

Do not operate your layout unattended. Obstructed accessories or stalled trains may overheat, resulting in damage to your layout.

This train set is intended for indoor use. Do not use if water is present. Serious injury or fatality may result.

Do not operate the hobby transformer with damaged cord, plug, switches, buttons or case.

Introduction To The AIU

The Accessory Interface Unit (AIU) turns the DCS System into a complete layout control system. Each AIU controls up to 10 accessories and 10 switches (turnouts) and allows you to control routes and scenes through your remote control.

The AIU itself is essentially a box of relays that is especially designed to receive signals from the DCS System. The remote tells the AIU which relay to trigger, and it sets the accessory or switch into motion.

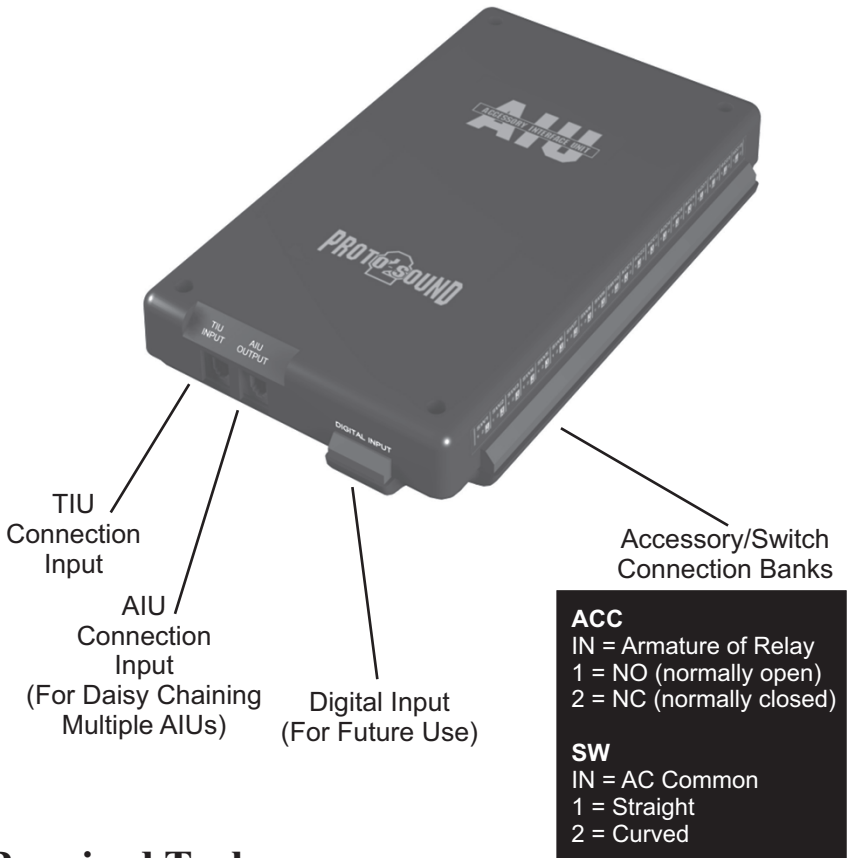

Required Tools

A flathead jeweler's screwdriver for wiring into the AIU

Installing The AIU Into The DCS System

Once you have completed the wiring and set up instructions below, it is easy to activate accessories and throw switches using only the thumbwheel and a single softkey. Be careful to wire each accessory as its instructions dictate, and you will have your system working in no time.

Wiring To TIU

Plug one end of the AIU/TIU cable (included) into the “TIU Input” port on the AIU and the other end into the “AIU Input” port of the TIU.



Daisy Chaining AIUs Together

Plug one end of the AIU/TIU cable (included with second AIU) into the “AIU Output” port of the first AIU (connected to the TIU) and the other end into the “TIU Input” port of the second AIU.

NOTE: You can daisy chain up to five AIUs for each TIU on your layout.



Programming AIUs Into The DCS System

Before you can add accessories and switches for activation by DCS, you must first read all connected AIUs into the system.

With all TIUs and AIUs properly wired and the transformer set to 18v, press READ on the DCS handheld. The system will automatically locate and add new AIUs to its map.

See the DCS System Operating Instructions for complete instructions on adding and numbering the TIUs on your system.

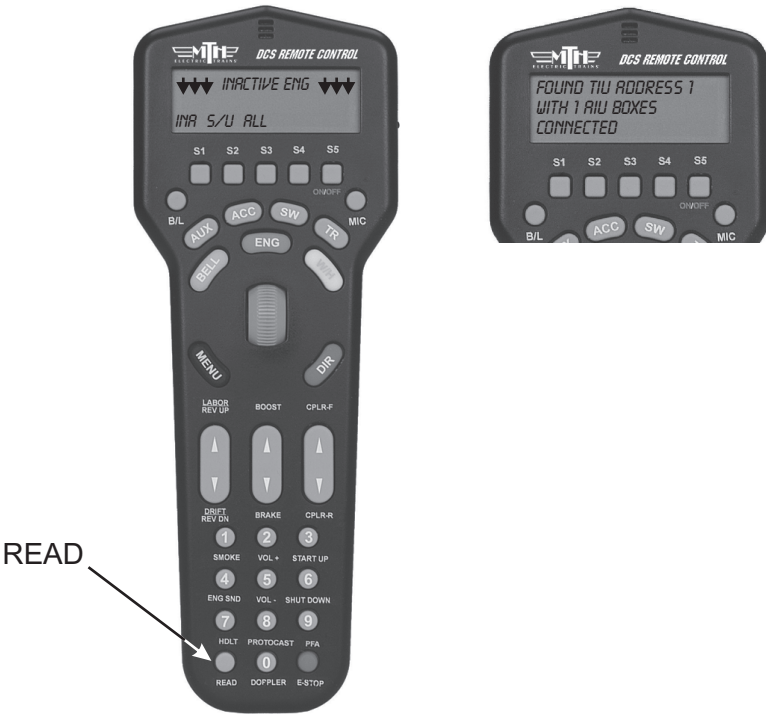

Wiring Accessories and Switches

You can wire up to 10 accessories plus 10 switches into each AIU.

Because accessories come in so many different configurations, you should carefully check the wiring instructions for each specific accessory before connecting to the AIU. Below are general guidelines to help you complete this wiring.

Operating Track Sections

(Wired For Track Power)

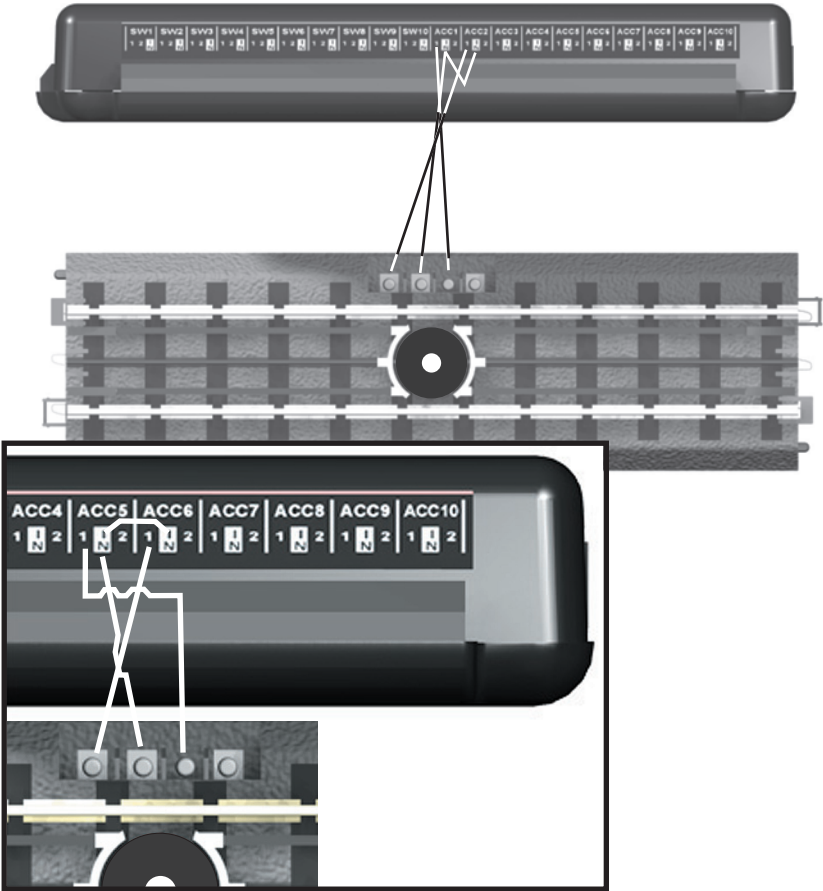

Switches/Turnouts

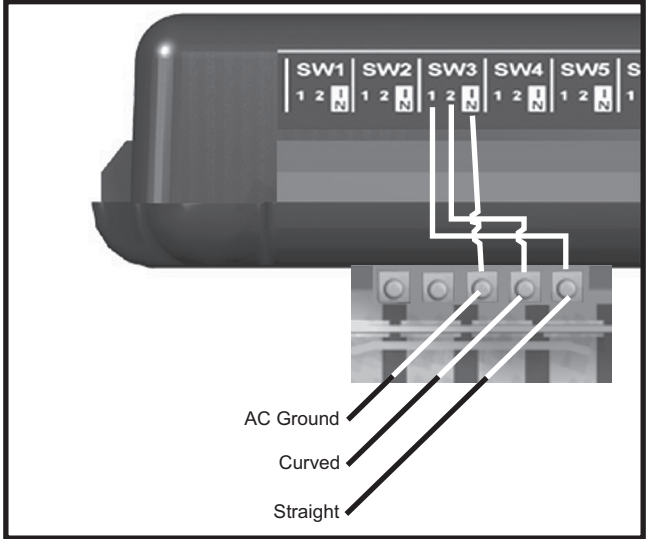
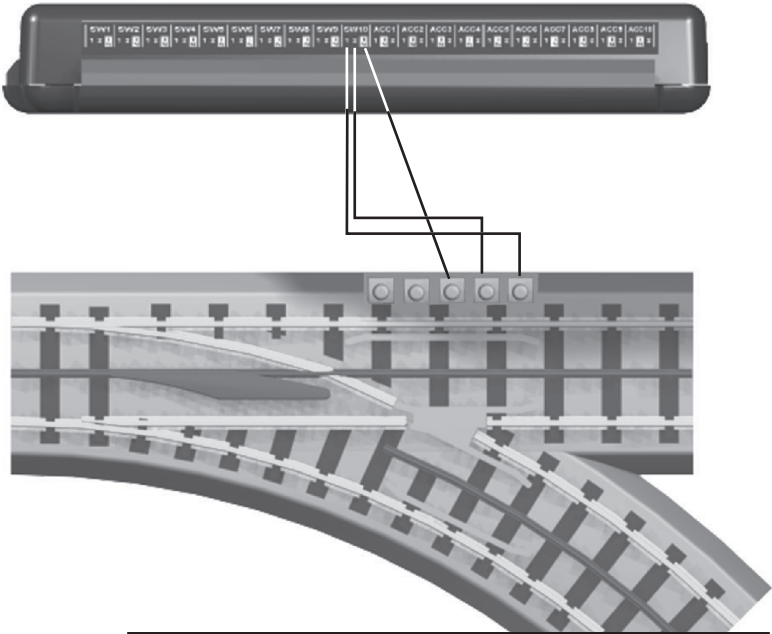

Accessories With Two Contacts

Examples Include:
Lighted Row House
Operating Radar Tower
Operating Rotary Beacon

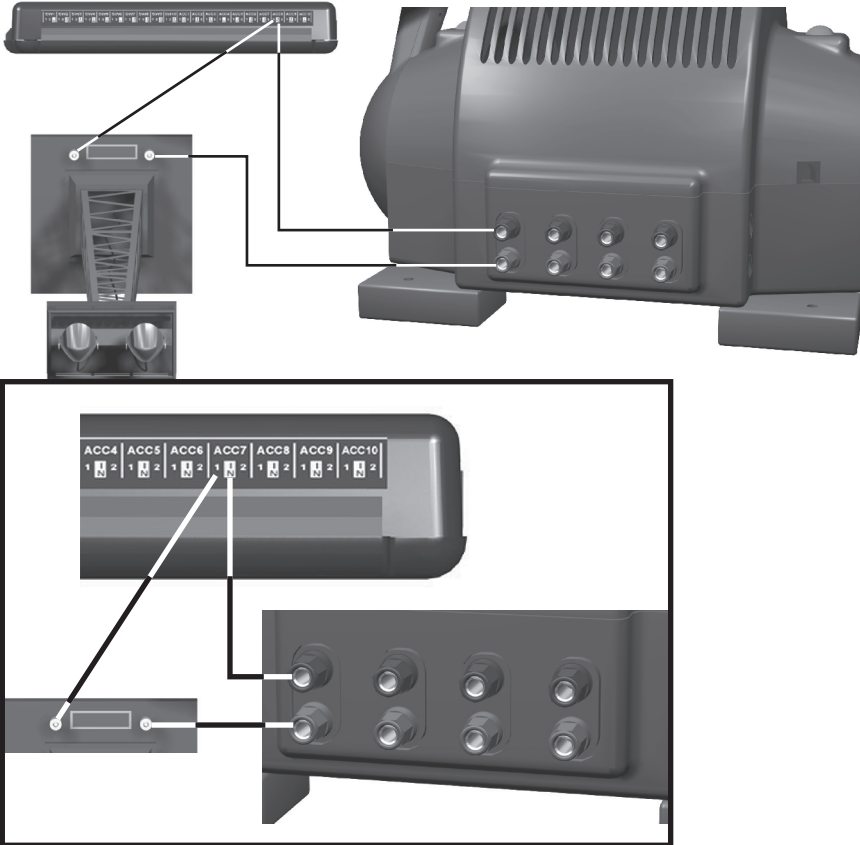

Accessories With Three Contacts

Examples Include:
Operating Semaphore
Operating Block Signal

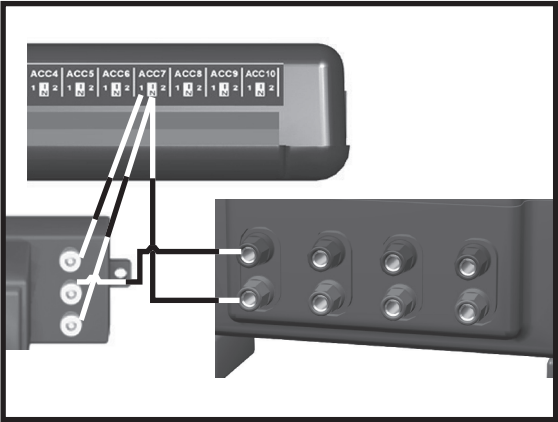
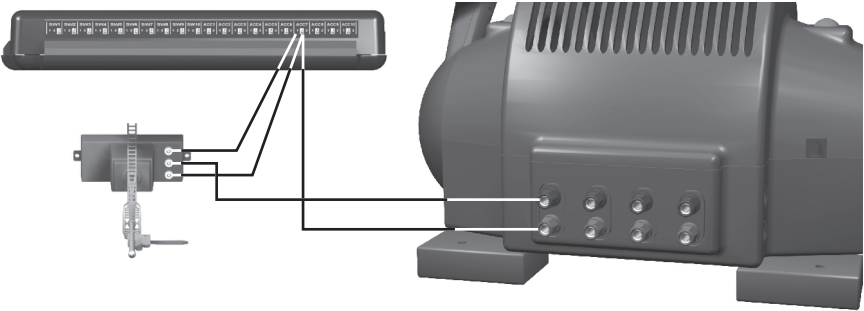

NOTE: Accessories controlled by a track activation device (TAD) or infrared track activation device (ITAD) can be wired up to the AIU as well as the TAD or ITAD. Such a configuration will allow the accessory to be triggered remotely by the AIU and DCS remote or via a train on the track when passing by the TAD or ITAD. Wire the accessory to the AIU as described on the preceding and following pages.

Accessories With Four Contacts

Examples Include:
Operating Passenger Platform

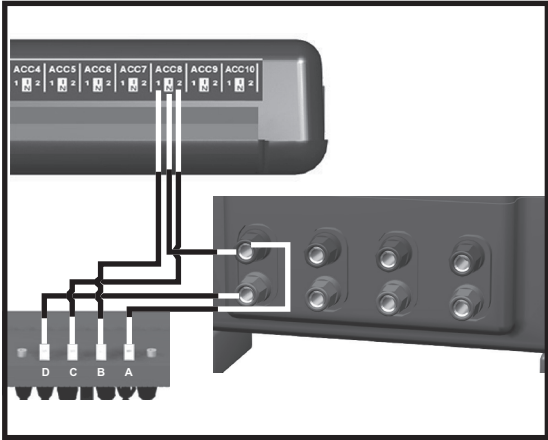
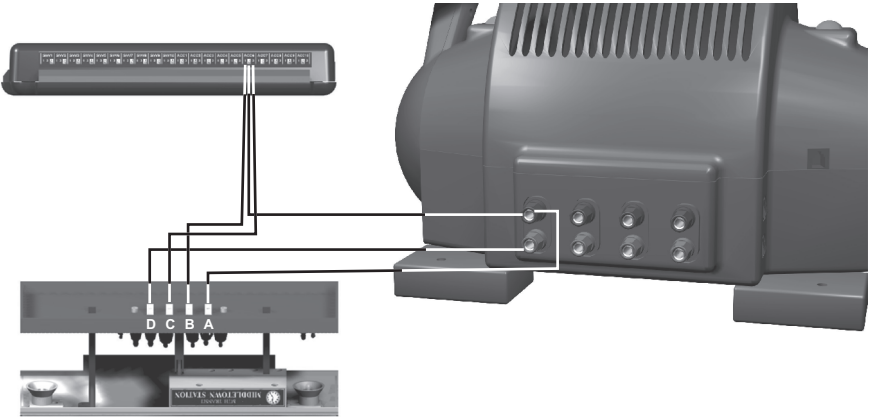

NOTE: To control lights and operation separately, you can wire the lights into one ACC port and the operation wires into another.

Accessories With Five Contacts

Examples Include:
Operating Car Wash
Operating Gas Station
Operating Firehouse

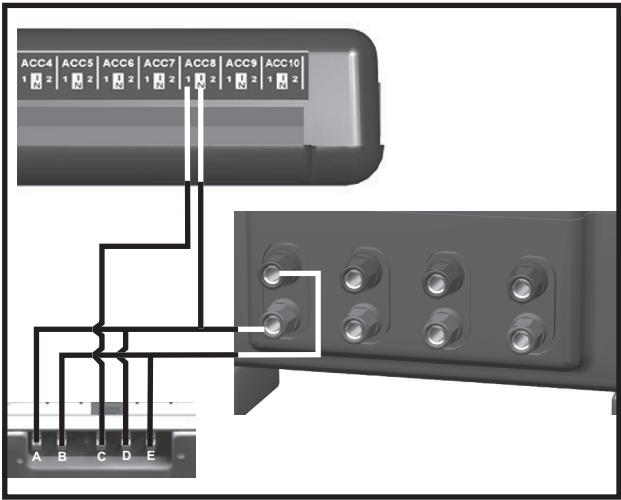
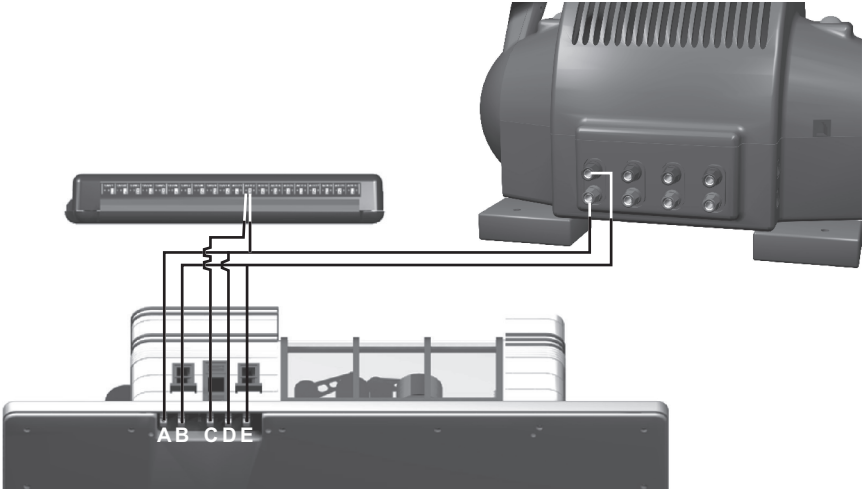

Programming Individual Accessories & Switches Into The DCS System

Programming Accessories

Turn off the power supply, then make sure the accessory has been wired into the AIU as shown in the preceding examples and according to your accessory's instructions.

Power up to 18 volts and press READ on the DCS handheld to add your AIU to the DCS system (see page 5 for more explanation). Go through the DCS handheld's menu as follows:

1. Press the Black MENU button to bring up the four main menus in the DCS system.

Press Menu

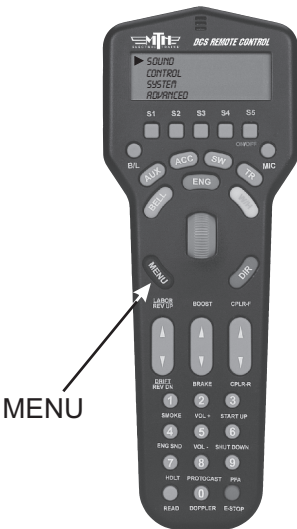

2. Using the thumbwheel, scroll down the menu list until you arrive at System.

3. Press the thumbwheel to enter the System Menu. Your screen should reveal at the bottom that you are in the System Menu.

4. Scroll and select Accessory Setup from the available choices in the System Menu.

5. Scroll and select Add Accessory from the available choices in the Accessory Setup Menu.

Scroll and Select System



Scroll and Select Accessory Setup



Select Add Accessory

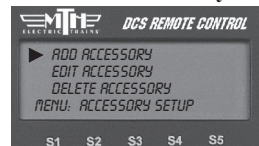

Programming Accessories (cont'd)

6. Select which TIU the accessory is wired to (via the AIU) (See the TIU Setup section in the DCS User's Manual for how to number TIUs.)

7. Select which AIU the accessory is added to. To determine the AIU's number, simply count out from the TIU. For instance, if you have three AIUs, the one connected directly to the TIU is AIU1, the one connected directly to AIU1 is AIU2, and the one connected directly to AIU2 is AIU3.

8. Select the AIU port (ACC1-ACC10) the accessory is wired into.

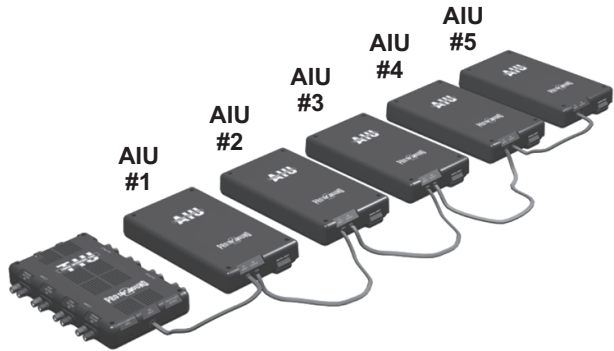

Select TIU To Use

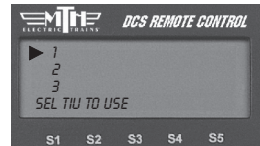

Select AIU To Use

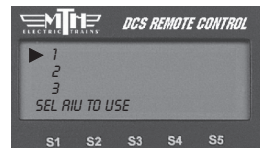

Select Accessory

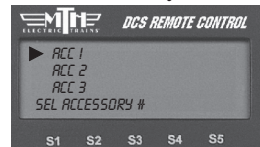

Select Characters For Accessory Name (Highlighted by Brackets)

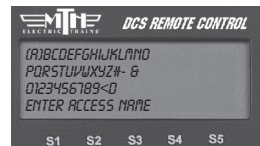

Programming Accessories (cont'd)

10. You may give the accessory a name up to 16 characters long. Select the “D” at the end of the character set to signify that you are done with this function.

11. The accessory will now show up, by the name you have assigned, on the accessory screen when you press the DCS handheld’s ACC button.

See the DCS System Operating Instructions for complete instructions on editing and renaming accessories and for instructions on adding and numbering TIUs.

Select Characters For Accessory Name



Select the "D" Character To Enter Name For Accessory

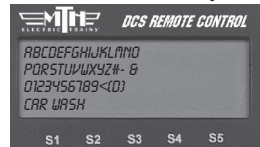

Accessory Name As Seen In The Accessory List

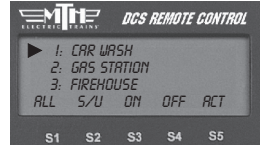

Programming Switches

Turn off the power supply, then make sure the switch has been wired into the AIU as shown in the preceding examples and according to your switch's instructions.

Power up to 18 volts and press READ on the DCS handheld to add your AIU to the DCS system (see page 5 for more explanation). Go through the DCS handheld's menu as follows:

1. Wire the switch into the AIU as shown in the AIU user's manual and your track's instructions.
2. Go through the DCS handheld's menu as follows:

Press Menu



MENU

A. Press Menu Button

B. Select System

C. Select Switch Setup

D. Select Add Switch

Scroll and Select System

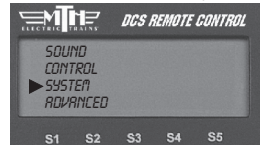

Scroll and Select Switch Setup



Select Add Switch

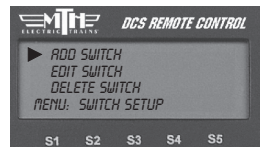

Select TIU To Use

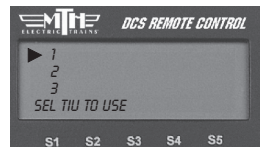

3. Select which TIU the switch is wired to (via the AIU).

Programming Switches (con'd)

4. Select which AIU the switch is added to. (See the explanation for counting AIUs in the Programming Accessories section on page 13.)
5. Select the AIU port (SW1-SW10) the switch is wired into.



6. The LCD prompts you to name the switch, and an alphanumeric character set is displayed. Use the thumbwheel to scroll through the character set, and when the character you want to type next is bracketed, press the thumbwheel to select it. You may give the switch a name up to 16 characters long. Select the “D” at the end of the character set to signify that you are done with this function (See page 13 - 14 for more information on naming accessories).

The switch will now show up, by the name you have assigned, on the switch screen when you press the DCS handheld’s SW button.

See the DCS System Operating Instructions for complete instructions on editing and renaming switches and for instructions on adding and numbering TIUs.

Select AIU To Use

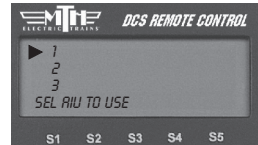

Select Switch

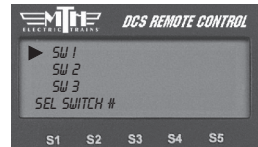

Select Characters For Accessory Name (Highlighted By Brackets)

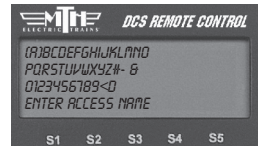

Select TIU To Use

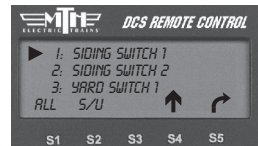

Activating Accessories And Switches

Once you have completed the wiring, mapping, and naming steps, you can easily activate an accessory or switch.

1. Press the handheld's ACC (for accessory control) or SW (for switch control) button.
2. Scroll the thumbwheel until the arrow points to the accessory or switch you want to activate.
3. Press the softkey under the option you choose (see below for options).

Press ACC or SW

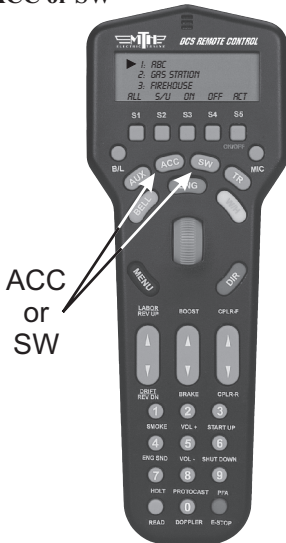

Scroll To Select

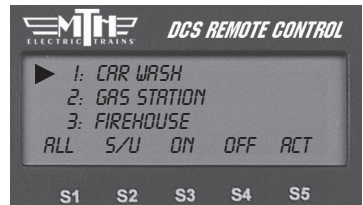

Press Softkey Option



For accessories the softkey options are ALL, S/U, ON, OFF, ACT. ALL triggers all accessories connected to any TIU and receiving track power. S/U takes you to the handheld's setup menu, where you can add, edit, or delete an accessory. ON turns accessories on for continuous operation until you turn them off. OFF turns accessories off. ACT activates accessories for single, not continuous, operation.

Activating Accessories & Switches (con'd)

For switches the softkey options are ALL, S/U, \uparrow or \curvearrowright ALL triggers all switches connected to any TIU and receiving track power to move into the position you select. S/U takes you to the handheld's setup menu, where you can add, edit, or delete a switch. \uparrow throws the switch straight. \curvearrowright throws the switch curved.

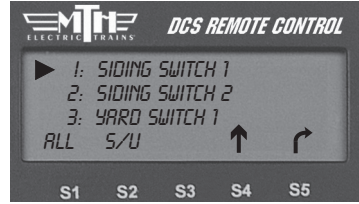

NOTE: Unlike with engines, the ALL button for accessories and switches does not distinguish between active and inactive. The button activates every accessory or switch that is connected to a TIU and receiving track power.

Troubleshooting DCS AIU Problems

Although DCS has been designed and engineered for ease of use, you may have some questions during initial operation. The following table should answer most questions. If your problem cannot be resolved with this table, visit the MTH Proto-Sound web site for more information and instructions for contacting MTH for direct service.

www.protosound2.com

Accessory/Switch Doesn't Activate	Remedy
When I activate the accessory/switch from the handheld, nothing happens, or the wrong accessory/switch activates.	Check to make sure the accessory/switch is mapped correctly in the handheld. The DCS system knows only to activate whatever is wired into the AIU and port you map, so a mis-mapped model will not activate.
AIUs Don't Respond	Remedy
I have multiple AIUs daisy chained together, but the accessories on the last AIUs in the chain do not activate properly.	Make sure you are using the AIU/TIU cables included with the AIUs. While other cables may look similar, they may cause voltage drop and drain off too much power for the signal to reach the outer AIUs.
Switch Sticks	Remedy
The switch opens but won't close.	There is no reason the AIU should cause this. Check your switch and wiring for defects. (See Page 7)

Service & Warranty Information

Limited One-Year Warranty

M.T.H. products purchased within one year from the date of manufacture are warranted against defects in material or workmanship, excluding wear items such as light bulbs, pick-up rollers, batteries, smoke unit wicks, and traction tires. M.T.H. Authorized Retailers will replace, refund, or credit the defective item if:

- The item was manufactured within the previous year
- It was purchased from M.T.H. directly by an M.T.H. Authorized Retailer or directly from an M.T.H. Distributor by an M.T.H. Authorized Retailer

IMPORTANT NOTE: This warranty does not cover damages caused by improper care, handling, or use. Transportation costs incurred by the customer are not covered under this warranty.

Purchases from eBay or other online auction or selling sites will NOT be covered under warranty unless the seller is an M.T.H. Authorized Retailer.

See our website at www.mthtrains.com to identify an M.T.H. Authorized Retailer near you.

This warranty gives you specific legal rights, and you may have other rights that vary from state to state. Specific questions regarding the warranty may be forwarded to M.T.H. directly.

M.T.H. Electric Trains
6660 Santa Barbara Road, Suite 20
Elkridge, MD 21075

How to Get Service Under the Terms of the Limited One-Year Warranty

This item carries a one-year warranty from the date of manufacture for the M.T.H. Authorized Retailer who sold the product. The defective item should be returned to the dealer where purchased.

If the dealer has trained service techs, they can offer to repair the item (M.T.H. will supply warranty parts as needed free of charge. If parts are not available a refund will be given to the dealer).

M.T.H. will no longer provide repair service on any products at its corporate headquarters.

If an item is defective and cannot be repaired, it needs to be returned to the original purchasing dealer and the end-user can obtain a refund from the retailer. The original purchasing dealer will then return the item to M.T.H. for credit.

Customers may want to request that their items are tested by the retailer prior to taking the item home. All items are tested by M.T.H. Electric Trains prior to shipment from our production facilities.