



Premier 4-8-4 Niagara Steam Engine

OPERATOR'S MANUAL

Compatibility

Hi-Rail Wheels: This engine will operate on any traditional O-72 Gauge track system.

It is also compatible with most standard AC and DC transformers. (See page 45 and 46 for a complete list of compatible transformers and wiring instructions.)



PFA
Passenger/Freight
Announcements

PLEASE READ BEFORE USE AND SAVE
www.mthtrains.com

Table of Contents

Before you Begin	3
Set Up Checklist	3
Lubrication	3
Priming the Smoke Unit	4
Placing Engine On Track	5
PS 3.0 Enhancements	6
Conventional AC/DC Start-up/Shut-down	6
DCS/DCC Switch	6
Programming Track (for DCC operation)	7
Loading Engine Firmware	7
LED Lighting	7
Modes of Operation	7
Conventional AC Operation	8
Proto-Sound® 3.0 Conventional AC Operating Instructions	9
Activating Proto-Sound® 3.0 Conventional AC Mode Features	9
Manual Volume Control	10
Marker Lights (On / Off)	10
PFA	11
Proto-Coupler™ Operation	12
Speed Control	13
Locking Locomotive Into A Direction	13
Reset To Factory Default	14
Automatic Sound Effects	14
Conventional DC Operation	14
DCS Operation	15
DCC / Digital Command Control	15
Basic DCC Operation	16
Start up / Shut Down	16
Sounds	17
Lights	17
Master Volume	18
Couplers	18
Forward/Reverse Signal	18
Grade Crossing Signal	18
Smoke	18
Engine Sounds	19
Additional F Functions	19
Function Chart	21
CV29	22
Long and Short Addressing	22
Feature/Factory Resetting	23
Lost or Unknown Engine Address and the 55-55-55 Address Reset	24
M.T.H. Proto-Sound 3.0 Expanded DCC Functionality	25
Advanced DCC Operation	25
Configuration Variables	25
User Settable F-Function List	27
Custom Speed Tables	28
Advanced Consisting	29
Programming Track	32
Maintenance	34
Lubricating and Greasing Instructions	34
Cleaning The Wheels, Tires and Track	35
Traction Tire Replacement Instructions	35
Proto Smoke™ Unit Operation	36
Headlight Replacement Instructions	36
Troubleshooting Proto-Sound® 3.0 Problems	37
Transformer Compatibility and Wiring Chart	45
DC Power Supply Chart	46
Additional Features Accessible Of DCS Remote Control System	47
Service & Warranty Information	48
Limited One-Year Warranty	48

CAUTION: ELECTRICALLY OPERATED PRODUCT:

**Recommended for Ages 14 and up. Not recommended for children under 14 years of age without adult supervision.
As with all electric products, precautions should be observed during handling and use to prevent electric shock.**

WARNING: When using electrical products, basic safety precautions should be observed, including the following:

Read this manual thoroughly before using this device.

M.T.H. recommends that all users and persons supervising use examine the hobby transformer and other electronic equipment periodically for conditions that may result in the risk of fire, electric shock, or injury to persons, such as damage to the primary cord, plug blades, housing, output jacks or other parts. In the event such conditions exist, the train set should not be used until properly repaired.

Do not operate your layout unattended. Obstructed accessories or stalled trains may overheat, resulting in damage to your layout.

This train set is intended for indoor use. Do not use if water is present. Serious injury or fatality may result.

Do not operate the hobby transformer with damaged cord, plug, switches, buttons or case.

This product may be protected by one or more of the following patents: 6,019,289; 6,280,278; 6,281,606; 6,291,263; 6,457,681; 6,491,263; 6,604,641; 6,619,594; 6,624,537; 6,655,640.

Rev: 20st14919l_4-8-4 Niagara P&S 4/13/15

©2015, M.T.H. Electric Trains®, Columbia, MD 21046

BEFORE YOU BEGIN

By visiting the M.T.H. website, www.mthtrains.com, you will be able to view any additional manual updates that affect your engine. Enter the MTH Item number of the engine you want to check and select the manual icon to download or view it. You will need Adobe Acrobat Reader to view the manual.

You can obtain replacement parts and replacement instructions from the M.T.H. Parts Department. Order online: www.mthtrains.com, e-mail: parts@mth-railking.com, Fax: 410-423-0009, Phone: 410-381-2580, Mail: 7020 Columbia Gateway Drive, Columbia MD 21046-1532.

Set Up Checklist

- Lubricate Engine and Prime Smoke Unit
- Read all General Maintenance Instruction, starting on page 34
- Apply power to run as described in the Modes of Operation section on page 7

Getting Started

Lubrication

You should lubricate the engine to prevent it from squeaking. Use light household oil and follow the lubrication points marked “L” in Fig. 1. Do not over-oil. Use only a drop on each pivot point.

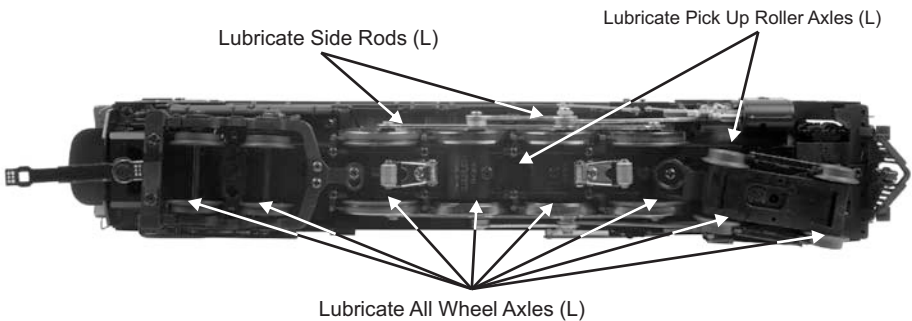
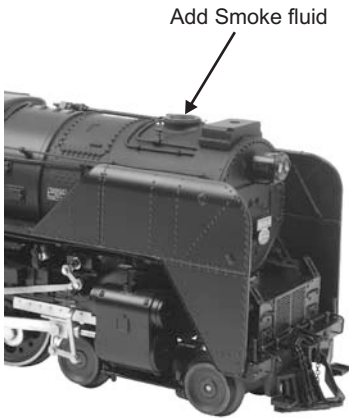

Fig. 1: Lubricating the Locomotive

Priming the Smoke Unit

When preparing to run this engine, add 15-20 drops of smoke fluid through the smokestack (shown below). We recommend M.T.H. ProtoSmoke™ fluid. Do not overfill the unit or the fluid may leak out and coat the interior engine components.

If you choose not to add smoke fluid (or have already added fluid but choose to run smoke-free), turn off the smoke unit by turning the smoke unit control to the “OFF” position, fully Counter Clockwise position. **Failure either to add fluid to the smoke unit or to turn it off may damage the smoke unit heating element and/or wicking material.** See the "ProtoSmoke Unit Operation" section of this book for more information on smoke unit maintenance.



 **Running the engine without a primed smoke unit may cause damage**

Figure 2: Adding Smoke Fluid

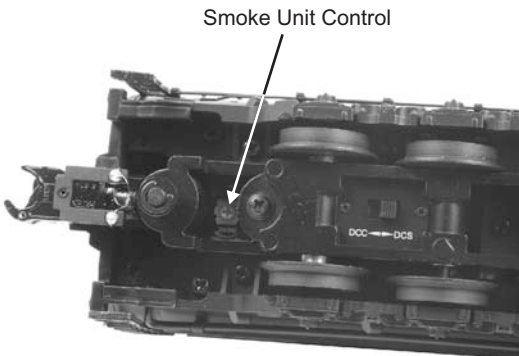

Figure 3: Smoke Unit Control

Placing The Engine On The Track

Your MTH steam engine is equipped with a tetherless drawbar. There is no unsightly cable or box showing between the engine and the tender to detract from the appearance of the model. The electrical connections pass through conductors in the drawbar, so it is important that the connector be properly inserted. The connector is fixed to the rear end of the drawbar. The mating connector is attached to a swivel connection on the front of the tender frame. The drawbar is connected to the engine chassis with a screw and should not need any attention.

In order to mate the connectors of the drawbar and the tender, place the engine and the tender on the track. Position the tender over the drawbar connector and insert the drawbar pin on the swivel connector into the hole in the drawbar.

Now grasp the tender with both hands as shown below and place a finger on each side of the drawbar near the connector. Now using your fingers, push the connectors together. The connector will make a slight click when it is properly seated. At this point you are ready to begin operating your engine.

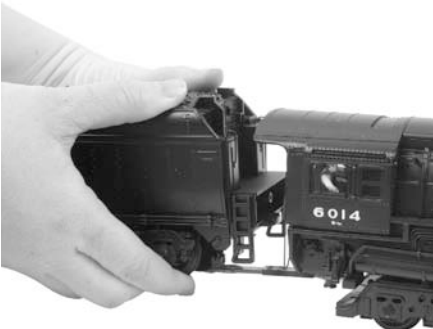

Figure 5: Connecting Locomotive to Tender



Figure 6: Engine and Tender

To disconnect the engine and tender apply downward pressure near the tender until the connectors separate.

The drawbar is able to withstand a 90 degree twist such as might be experienced in a derailment where the engine or the tender would turn over and the other unit would remain upright.

If the drawbar is not properly connected your engine may exhibit erratic or no operation. If this happens turn off the track power and make sure that the drawbar connectors are properly seated. Then reapply power to the track and continue operation.

PS 3.0 Enhancements

Here are some of the exciting changes incorporated into your new MTH Proto-Sound® 3.0 Locomotives. More advanced features such as Custom Speed Tables and Advanced Consisting can be found in the DCC section of this manual.

Conventional (Analog) AC/DC Start-up/Shut-down

Your new MTH PS3.0-equipped locomotive no longer has batteries. It uses Super Capacitors to hold the engine board alive for a short time when you shut off or interrupt track power. Because of this, when you first apply track power to your PS3.0-equipped O Gauge engine, you will notice the headlight comes on but nothing else. This is perfectly normal. The capacitors are charging up during this time. The wait time depends upon how long it's been since you last applied power to the engine. Typically it will take 1-15 seconds to fully charge. **NOTE: The 1-15 second charging wait time ONLY applies to conventional AC track power.**

Once the headlight shuts off, the engine will play its start-up sounds and all the lights will come back on, simultaneously. Smoke too if you have it turned on.

The capacitors hold enough charge to play the full shut-down sounds. Also, the capacitors allow you to operate your engine in conventional mode just like you would any other conventionally-controlled engine. Finally, because there are no batteries, you will notice there is no external charge jack on the engine.

DCS/DCC Switch

Your MTH PS3.0-equipped engine has a DCS/DCC selector switch (located on the underside of the tender in steam engines). To operate the engine in DCS mode, ensure the switch is set to DCS. If you wish to run the engine in DCC mode, ensure the switch is set to DCC.

If you inadvertently leave the switch in DCC it won't hurt anything, you just won't be able to communicate with your engine using DCS system. Likewise, if you leave the switch in DCS and try to operate the engine under DCC you may notice a humming coming from your engine and you will likely notice that your DCC system's overload light will be on.

CAUTION: Do not apply DCS signals and DCC signals to the same track simultaneously. The signals are not compatible, mixing the DCS and DCC signals WILL damage the DCS TIU unit.

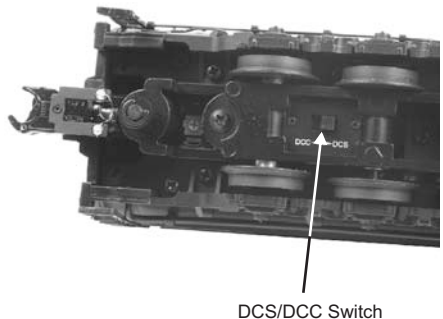

Figure 7: Changing from DCS to DCC Mode

Programming Track (for DCC operation)

Your MTH PS3.0-equipped O Gauge engine can function on Programming Track outputs from DCC systems. Most DCC systems can support the current requirements of the engine as long as it's not started up. If you plan on powering up the MTH engine on your programming track, you may want to consider a DCC Programming Track Booster.

Loading Engine Firmware

Your new MTH PS3.0-equipped O-Gauge engine affords you the ability to load Engine firmware. Loader version 2.30 or later will allow you to do this. Please refer to the Loader program's instructions for more details. So, as MTH releases new features or updates you will be able to take full advantage without having to ship your favorite engine anywhere. All new updates are available on our website. MTH will make announcements as they are available. Not all updates will apply to all engines.

NOTE: Requires a TIU w/ version 4.20 or later firmware, and requires Consumer Loader version 2.30 or later.

LED Lighting

Gone are the incandescent bulbs. Your new PS3.0-equipped engine has LED lighting. MTH uses various colored LEDs to simulate the correct lighting on your engines from the warm, yellow-orange colored light coming out of an old lantern on your favorite steam engine to the high-intensity halogen lamp on the latest modern diesels, LED's allow for various, correct colors. Also, they require less power and do not emit as much heat as incandescent bulbs.

Modes of Operation

There are 4 options for operating your MTH Proto-Sound[®] 3.0-equipped engine;

- Conventional AC
- Conventional DC
- DCS - MTH Digital Command System
- DCC

When the locomotive is placed on the track and power is applied to the track the locomotive will detect the type of control system being used and respond accordingly. Below is an overview of the 4 different systems.

NOTE: You'll need to have the DCC/DCS switch set correctly if your using one of those two modes.

Conventional AC Operation

When using conventional AC power, the engine will respond to changes in track voltage. An increase in track voltage will increase the locomotive speed and a reduction in track voltage will reduce the engine speed.

A short interruption (approximately 1 to 2 seconds) in the track voltage will cause the engine to cycle in the sequence for each track voltage interruption (neutral – forward – neutral – reverse) When power is first applied to the track, the locomotive will be silent for 1-20 seconds and the headlight will be on, indicating the super capacitors are charging (The super capacitors provide power to the sound system during direction changes or intermittent drops in track power due to dirty track or on switches, when operating in conventional mode). When the super capacitors are charged, all the lights will come on and the engine sounds will start up. There should be no movement, as the engine is in neutral. Causing a short interruption of track power by using the direction button on the transformer, or by bringing the throttle to 0 volts and back again, will change the sequence to the forward state. Then increasing the throttle will begin to move the engine forward, and speed will increase as the throttle is advanced.

If there is another interruption in track power the sequence will change to the neutral position again. The engine will remain in the neutral state until there is another interruption in track power. The next interruption in track power will move the sequence to the reverse state. The engine will now move in the reverse direction. If the power interruption was accomplished by using the direction button and the throttle position was not changed, the engine will run in the reverse direction at the same speed that it was traveling in the forward position.

Subsequent interruptions in track power of 1-2 seconds will continue the sequence rotation. If you happen to interrupt track power for longer than about 2 seconds, the engine will begin its shut down sounds. If this occurs you can cycle the direction sequence again to get back to the direction you wish to move and once the engine starts moving its shut down sounds will stop playing (SEE PAGE 9 (direction cycle phases)).

In conventional AC operation the whistle sound, the bell sound, PFA sounds and other operational functions can be accessed if your transformer has a horn/whistle button and a bell button. By using combinations of button presses, different commands besides blowing the whistle and ringing the bell can be initiated.

Proto-Sound[®] 3.0 Conventional AC Operating Instructions

Activating Proto-Sound[®] 3.0 Conventional AC Mode Features

Throttle - To increase or decrease track voltage, and therefore train speed, turn the throttle control knob. Turning clockwise will increase voltage and speed, while turning counterclockwise will decrease voltage and speed. The engine will maintain the speed you set after you release the throttle until you turn it again to change the voltage and speed.

Bell - To sound the bell, in an engine equipped with a bell firmly press and release the Bell button. To turn the bell off, press and release the Bell button again. The bell will continue to ring from the time you turn it on until you press and release the button again to turn it off.

Horn/Whistle - To sound the whistle, firmly press the Horn/Whistle button. The whistle will sound for as long as you continue to depress the button. It will stop when you release the button.

Direction - Your train is programmed to start in neutral. The train will always cycle neutral-forward-neutral-reverse with each press and release of the direction button. The engine is programmed to restart in neutral each time the track voltage is turned off for 25 seconds or more.

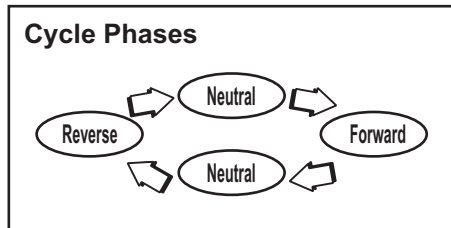

Manual Volume Control

To adjust the volume of all sounds made by this engine, turn the manual volume control (fig. 8) clockwise to increase the volume and counterclockwise to reduce the volume. Turning the manual volume control completely counterclockwise will turn off all of the engine sounds and announcements.

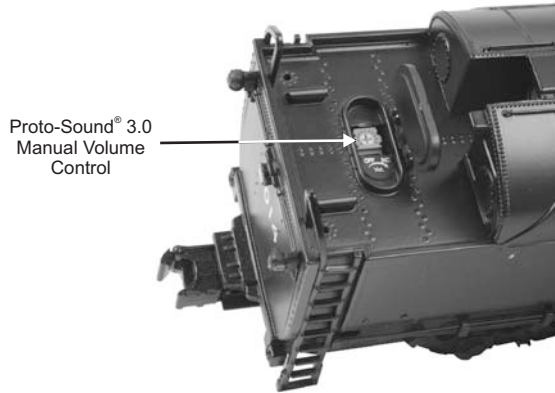

Figure 8: Manual Volume Control

Proto-Sound® 3.0 features are activated by sequences of Bell and Horn button pushes described below. Please read the full descriptions of each feature before using it. To use these buttons to activate features rather than to blow the horn or ring the bell, you should tap the buttons very quickly with a 1/2-second pause between button presses. You may need to practice your timing to make this work smoothly.

Timing Chart				
Press Horn Short & Firm	1/2 Sec. Pause	Press Bell Short & Firm	1/2 Sec. Pause	Press Bell Short & Firm
Total Time Lapse: 1 1/2 Seconds				

Feature to Be Activated	Button Code:
Marker Lights*	1 Bell, 1 Horn/Whistles
PFA (Passenger/Freight Announcements)	1 Bell, 2 Horn/Whistles
Fire the Rear Coupler	1 Bell, 3 Horn/Whistles
Fire the Front Coupler	1 Bell, 4 Horn/Whistles
Speed Control On/Off	1 Horn/Whistle, 2 Bells (from Neutral only)
Lock into a Direction	1 Horn/Whistle, 3 Bells
Reset to Factory Defaults	1 Horn/Whistle, 5 Bells (from Neutral only)

**Only applicable to engines equipped with marker lights*

Marker Lights (On/Off) (if equipped)

By default your Marker Lights are set to ON. To toggle the Marker Lights, perform the following sequence on your AC transformer:



Passenger/Freight Announcements (PFA)

Your engine is equipped with a sound package of either passenger station announcements or freight yard sounds that you can play when you pull into a station or a yard. Each sequence described below will play as long as it is left on, randomly generating sounds, but be sure to allow approximately 30 seconds between the button pushes described below to allow the PFA sufficient time to run through each sequence.

- To cue the sound system to play the PFA, quickly but firmly tap the Bell button once followed by 2 quick taps of the Horn button while the engine is moving. Tap the buttons quickly but allow approximately ½ second between each press.
- Press the Direction button once to stop the engine. This will trigger the first sequence of PFA. The reverse unit is temporarily disabled so that the train will not move as you use the Direction button to trigger the sounds. Proto-Sound 3.0 has disabled operator control over the Horn and Bell buttons until the full PFA sequence is complete.
- After waiting about 30 seconds for that sequence to run, press the Direction button again to trigger the second sequence of PFA.
- After about 30 seconds, press the Direction button again to trigger the third PFA sequence.
- Again, after allowing about 30 seconds for that sequence to run, press the Direction button one more time to trigger the fourth and final PFA sequence. The PFA will continue and within a few seconds the bell will begin ringing, then the engine will begin moving at the current throttle setting, in the same direction it was traveling when you began the sequence. Once the bell turns off, the operator regains control of the transformer's bell and Horn buttons and can ring the bell or blow the Horn as usual.

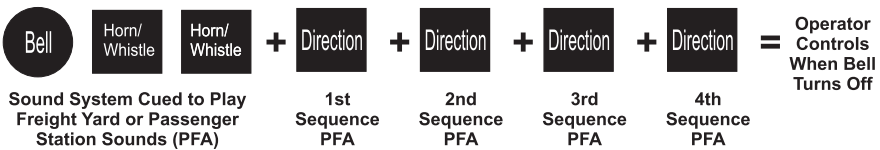

Tips on Using PFA

- You can terminate PFA at any time by turning off power to the track for 15 seconds.
- You do not have to be in Forward to use PFA. At the conclusion of the full sequence, the train will pull away from the station or yard in whatever direction you were going when you activated the feature.
- You can use PFA even if you are double-heading with another engine. If the second engine is not equipped with Proto-Sound® 3.0, you must remember not to leave the throttle at a high voltage level once you have stopped the engine to run the PFA. Otherwise, the engine without PFA will begin vibrating on the track as its motors strain to move the train, since they cannot be automatically disabled during the PFA cycle (or if an original Proto-Sound® engine, PFA are triggered differently and that engine's motor-disable feature will not be active when you run PFA in Proto-Sound® 3.0).
- PFA can be triggered from Neutral. It will operate the same as if triggered while in motion except that, at the conclusion of the PFA, the engine will depart in the next direction of travel, as opposed to the direction it was traveling before entering Neutral.

Proto-Coupler™ Operation

This locomotive is equipped with one or more coil-wound Proto-Couplers for remote uncoupling action. Because Proto-Couplers are controlled through the Proto-Sound® 3.0 microprocessor, they do not require an uncoupling track section or modification to your layout to function. You can fire a coupler from neutral or while in motion. Use the code shown below (and in the chart on p. 21) to fire the coupler(s).

Rear Coupler:

To fire the rear coupler, quickly tap the Bell button once followed by three quick taps of the Horn button, allowing approximately 1/2 second to lapse between each quick button press. The sound of the liftbar and air line depletion will play, and the knuckle will be released.



Front Coupler:

To fire the front coupler (if your engine has one), quickly tap the Bell button once followed by four quick taps of the Horn button, allowing approximately 1/2 second to lapse between each quick button press. The sound of the liftbar and air line depletion will play, and the knuckle will be released.



Speed Control

M.T.H. engines equipped with Proto-Sound® 3.0 have speed control capabilities that allow the engine to maintain a constant speed up and down grades and around curves, much like an automobile cruise control. You can add or drop cars on the run, and the engine will maintain the speed you set.

While the engine is programmed to start with the speed control feature activated, you can opt to turn it off. This means the engine's speed will fall as it labors up a hill and increase as it travels downward. It is also affected by the addition or releasing of cars while on the run. Because the engine will run more slowly at a given throttle voltage when speed control is on than when it is off, you should adjust the throttle to a lower power level for operation with speed control off to avoid high-speed derailments. When speed control is off, the volume will drop to allow for better low voltage operation.

To turn speed control on and off, put the engine in neutral, then quickly tap the transformer's Horn button one time then quickly tap the Bell button two times, allowing approximately ½ second to lapse between each quick button press. Two horn blasts will indicate that the engine has made the change. Repeat the 1 horn, 2 bells code to return it to the other condition. You will want to do this during the initial neutral upon start-up if you ever couple this engine to another engine that is not equipped with speed control to avoid damaging the motors in either engine. Each time you shut down the engine completely, it will automatically turn speed control on.



Locking Locomotive Into A Direction

You can lock your engine into a direction (forward, neutral, or reverse) so that it will not change directions. To do this, put the engine into the direction you want (or into neutral to lock it into neutral), run it at a very slow crawl (as slowly as it will move without halting), and quickly but firmly tap the Horn button once followed by three quick taps of the Bell button, allowing approximately ½ second to lapse between each quick button press. Two horn blasts will indicate that the engine has made the change. The engine will not change direction (including going into neutral) until you repeat the 1 horn, 3 bells code to return the engine to its normal condition, even if the engine is kept without power for extended periods of time.



Reset to Factory Default

To override the settings you currently have assigned to the engine and reset it to its factory defaults, while in Neutral tap the Horn button quickly once, followed by five quick taps of the Bell button, allowing approximately ½ second to lapse between each quick button press. Two horn blasts will indicate that the engine has made the change.



Automatic Sound Effects

Certain Proto-Sound® 3.0 sound effects automatically play in programmed conventional mode conditions:

- Squealing Brakes play any time the engine's speed decreases rapidly.
- Cab Chatter plays at random intervals when the engine idles in neutral.
- Engine Start-up and Shut-down sounds play when the engine is initially powered on or is powered off for five seconds or more.

Conventional DC Operation

Your MTH locomotive will operate on conventional DC track voltage also. However, functions such as sounding the horn, ringing the bell and the PFA sounds cannot be initiated in conventional DC. Only the engine sounds, smoke, squealing brakes and idle sounds will function.

Operation of your MTH Proto-Sound® 3.0 engine in conventional DC is very similar to operating a conventional AC engine. As you increase track voltage, engine speed increases.

As the track voltage is decreased, engine speed is decreased. When track voltage polarity is reversed using the polarity or direction switch on the power pack, the engine will run in the opposite direction. The electronics in your MTH Proto-Sound® 3.0 locomotive are designed to slowly change direction without a need to change the throttle, if you so desire.

Just change the polarity switch on your DC power pack and the engine will gradually come to a stop and then automatically begin traveling in the opposite direction. The speed will build up to the same speed that the engine was going in the previous direction. When power is first applied to the locomotive, the engine's sounds will start up when the track voltage reaches about 8 VDC. To get your locomotive moving, after the startup sounds have finished and the locomotive is idling, slowly increase the track voltage until the locomotive is traveling at the desired speed.

NOTE: If you apply more than 9.0VDC to the engine at start-up the engine will not move. This is normal. We refer to this as “Anti-Jackrabbit” and this feature prevents your model from taking off at high track voltages. Simply lower the track voltage down below 9.0VDC and then back up to get your engine moving. This applies only when you start up your engine.

DCS - Digital Command System

While the acronyms are close, this is where the similarity ends between DCC and DCS. Yes they are both digital control systems. However, M.T.H. DCS is not DCC. There are several proprietary versions of DCC on the market, but DCS is not one of them. M.T.H.'s DCS System is a proven technology in the O Gauge, One Gauge, and HO Gauge markets. First the power signal in DCS is not the command signal. Next DCS employs a fully functional bi-directional communication scheme opening a vast range of advanced features and yet so simple and intuitive that you can enjoy them. No programming tracks, bits and bytes, or conversion of binary to hexadecimal numbers here. To add an engine in DCS, press “ADD ENGINE”. After that, if you want to start your engine just press “START UP” or to turn the smoke unit on or off, just press “SMOKE”. No combination of letters or numbers to remember.

Additional details can be found in the DCS manual that accompanies your DCS system or on the MTH Web site, www.mthtrains.com. With DCS, you can have a whole fleet of MTH PS 3.0 engines on the rails and they will remain shut down until you command them to start up.

DCC - Digital Command Control

DCC is a popular digital command scheme wherein the track power is also a digital control signal. That is, using a DCC controller, you can communicate with multiple engines and have all of them moving at different speeds and in varying directions on the same track at the same time. The power/command signal remains constant and engines are commanded to perform as desired. Your MTH PS3.0-equipped engine has the ability to decode and respond to these DCC commands. This allows you to mix and match MTH PS3—equipped engines as well as operate them with any other manufacturer's DCC-decoder equipped engine. The best part about your MTH PS3.0-equipped engine is that the decoder is built right in. No need to remove the body shell and install speakers or boards. It's all done for you at the factory. Each PS3.0-equipped engine has a full complement of lights, sounds, smoke (if equipped). Just set the model on the rails, apply DCC power and hit F3 on your DCC handheld controller and you're off and running.

Basic DCC Operation

Your MTH PS3.0-equipped engine takes full advantage of DCC's capabilities. Below are the basic commands you'll want to know to get started running quickly. Please refer to the Advanced DCC Operation section of the manual if you want to dig into the full capability of DCC.

Each engine type may have a slightly different F Function list. This depends upon whether it's steam, diesel, or electric and whether it has smoke or not. Please refer to the table of Default CV Values for your particular engine's F Functions.

A note about enabling/disabling F Functions in DCC - Depending upon the DCC system you have you may need to toggle a particular F Function on then off to actually get it to enable. Some DCC systems do this for you automatically and others allow you to set particular F Function buttons to either be set for momentary or toggle. Please refer to your DCC control station manufacturer's manual for more information on how they handle F Function buttons.

Your MTH PS3.0-equipped engine's default short address is 3. So all you have to do is power up your DCC system and call up Locomotive 3 to begin.

Start-Up/Shut-Down

F3 – Start-Up/Shut-Down

Pressing this twice (toggle on then off) will start up your engine. When you apply DCC power your MTH PS3.0-equipped engine will remain dark and quiet. Since you likely don't want to run the engine this way, simply press F3 twice to start your engine. The lights, sound and smoke (if equipped) will come on.

Note: The engine sounds will start up and engine will move when the throttle is advanced. It is no longer necessary to start the engine using the F3 command. Although you can start the engine sounds either way.

To shut your engine down, press the F3 button twice. This will play the shut down sounds and then turn the lights and smoke and sounds off. As long as there is DCC power still on the track the engine can be started up again by pressing the F3 button twice.

Bell/Whistle (Horn)

F1 – Bell

To activate the Bell press F1. To deactivate it, hit F1 again

F2 – Whistle (Horn)

To activate the Whistle/Horn, press F2. To shut it off either let off the F2 button or press and release it

PFA

F4 – PFA

PFA in MTH lingo stands for Passenger/Freight Announcements. Your engine is pre-programmed for the appropriate type of sounds based upon the type of service the real-life engine used in daily operation.

There are five sound sequences or segments in the PFA feature. Each segment is advanced by you, the operator. You hit the F4 button twice on the DCC controller to let the engine know you want it to advance (this toggles the PFA function on then off to clear the remote for the next sequence). In most PFA sequences there is a minimum wait time of about 20-30 seconds before it will advance. So, here is how a typical PFA sequence operates:

1. Press the F4 button twice (toggle F4 on then off) to start the PFA sequence on the engine. You'll hear "Now arriving..." for passenger sound sets and cab chatter for freight sound sets. The bell will then begin ringing.
2. Slowly reduce the throttle until the train stops at the desired location and speed reaches zero. Press the F4 button twice (toggle F4 on then off) again and the bell will stop ringing. You will hear the engine sounds switch from the cab to the station or yard with all the ambient sounds you'd hear in the real thing.
3. Press the F4 button twice (toggle F4 on then off) again to advance the sequence. You'll hear "Now boarding..." for passenger sound sets and freight yard sounds for freight sound sets.
4. Press the F4 button twice (toggle F4 on then off) again to advance the sequence. You'll hear "Now departing..." for passenger sound sets and more freight yard sounds for freight sound sets.
5. Press the F4 button twice (toggle F4 on then off) the last time to advance the sequence. You'll hear "All aboard..." for passenger sound sets and more freight yard sounds for freight sound sets. The engine sounds will switch over to the cab again. When the bell begins to ring, advance the throttle to move the engine out of the station or yard. The bell will shut off automatically.

Lights

F0 – Headlight/Taillight

This toggles your headlight/taillight on and off.

F5 – Lights

This toggles your firebox and cab interior light on and off.

Master Volume

F6 – Master Volume

There are 10 volume levels. Pressing F6 twice (toggling on then off) raises the Master Volume one level. The Master Volume loops. That is, if you go past the 10th level it will loop back around to the 1st or lowest volume level.

Couplers

Your MTH PS3.0-equipped engine comes with remotely controlled Proto-Couplers. They can be fired using your DCC handheld.

F7 – Front Coupler

Pressing F7 twice (toggling on then off) will fire your Front Coupler

F8 – Rear Coupler

Pressing F8 twice (toggling on then off) will fire your Rear Coupler

Forward/Reverse Signal

Just like a real engine, you can announce the direction of intended movement using your DCC handheld and F9 and F10.

F9 – Forward Signal

Pressing F9 twice (toggling on then off) will sound the Forward Signal. This is two whistle/horn blasts

F10 – Reverse Signal

Pressing F10 twice (toggling on then off) will sound the Reverse Signal. This is three whistle/horn blasts

Grade Crossing Signal

Again, just like a real engine, you can trigger the Grade Crossing Signal on your engine. This is two long, one short, one long whistle/horn blast.

F11 – Grade Crossing Signal

Pressing F11 twice (toggling on then off) will sound your Crossing Signal.

Smoke (if Equipped)

F12 – Smoke On/Off

Enabling F12 will turn the smoke unit on. Disabling F12 will turn your smoke unit off.

F13 – Smoke Volume

There are three smoke volume levels in your MTH PS3.0-equipped engine – Low/Med/High. The default for this is set to High. You can adjust the smoke output (amount of smoke the generator puts out) by pressing the F13 button twice. This sets the level to the next step. For example, if you are currently at the High smoke output level, pressing F13 twice (toggling it on then off) will set the smoke volume to Low. Pressing F13 twice again will set it to Medium and so on.

Engine Sounds

F25 – Engine Sounds

You can turn the Engine Sounds On/Off by pressing the F25 button. Pressing it once (enabling F25) will cause the Engine Sounds to shut off. The Whistle/Horn and Bell sounds will still be active, however. To turn the engine sounds back on press the F25 button again (disable F25).

Additional F Functions

NOTE: The engine must be sitting still in order to trigger F-Functions F14 through F18

F14-F16 – Idle Sequence

Pressing F14, F15, or F16 twice (toggling on then off) will trigger an Idle Sequence if the engine is not moving. These vary from engine to engine and may include things like checking the coal load, checking the water level, using the Alemite grease gun on the drivers, etc. When triggered, these will run through the sequence that varies in duration.

F17 – Extended Start-Up

If your engine is shut down or you've just applied DCC power pressing F17 twice (toggling it on then off) will start the Extended Start-Up sounds. This is very similar to F3 except you will hear the crew talking back and forth about getting the engine ready to run.

F18 – Extended Shut-Down

If your engine is already up and running you can play the Extended Shut Down sounds by pressing F18 twice (toggling on then off). The Extended Shut Down is very similar to F3 in that the engine will ultimately shut down, but in the case of Extended Shut Down you will hear the crew talking back and forth about how the engine ran, time schedules, etc.

F19 – Labor Chuff

To force the Labor Chuff sound in a steam engine, press the F19 button once (enable F19). As long as F19 is enabled the engine will play its Labor Chuff sounds. To set the sound back to Normal Chuff press the F19 button again (disable F19).

F20 – Drift Chuff

To force the Drift Chuff sound in a steam engine, press the F20 button once (enable F20). As long as F20 is enabled the engine will play its Drift Chuff sounds. To set the sound back to Normal Chuff press the F20 button again (disable F20).

F21 – One Shot Doppler

You can set your MTH PS3.0-equipped engine to simulate the actual Doppler Effect sound a real engine makes as it passes you. To do this, press the F21 button once (enable F21) and then listen as the engine makes that pitch shift that mimics the Doppler Effect perfectly. Press the F21 button again (disable F21) to shut off the Doppler Effect. With a little practice in timing and speed you can make this happen right in front of you.

F22 – Coupler Slack

When an engine hooks up and pulls a train it has to take up the coupler slack. You can play this sound by pressing F22 twice (toggling on then off). This feature works two ways – While the engine is sitting still, press F22 twice to enable it. Then, when you move the engine, it will play the Coupler Slack sound.

The second way is to simply force the sound while the engine is moving. To do this, simply press F22 twice (toggling it on then off). The sound will play.

F23 – Coupler Close

To play the Coupler Close sound press the F23 button twice (toggling it on then off). You can play this sound as you're coupling cars together to add realism.

F24 – Single Whistle/Horn Blast

To play a Single Horn Blast press the F24 button twice (toggling in on then off). This plays a single, short horn blast.

F26 – Brake Sounds

Pressing the F26 button (enable F26) will disable the Brake Sounds for your engine. The Brake Sounds occur when you reduce the speed of your engine rapidly. To enable the Brake Sounds press the F26 button (disable F26). Brake Sounds are On by default.

F27 – Cab Chatter

Cab Chatter occurs when the engine is sitting at idle. There are various times when the crew will talk to each other when the engine is sitting at idle. Pressing the F27 button (enable F27) will disable the Cab Chatter. Pressing the F27 button again (disable F27) will enable Cab Chatter. Cab Chatter is On by default.

F28 – Feature Reset

Resets Features to defaults.

FUNCTION CHART

F Key	Description
F0	Head/Tail light
F1	Bell
F2	Horn
F3	Start-Up/Shut Down
F4	PFA
F5	Lights (except head/tail)
F6	Master Volume
F7	Front Coupler
F8	Rear Coupler
F9	Forward Signal
F10	Reverse Signal
F11	Grade Crossing
F12	Smoke (On/Off)
F13	Smoke Volume
F14	Idle Sequence 3
F15	Idle Sequence 2
F16	Idle Sequence 1
F17	Extended Start-Up
F18	Extended Shut-Down
F19	Labor Chuff
F20	Drift Chuff
F21	One Shot Doppler
F22	Coupler Slack
F23	Coupler Close
F24	Single Horn Blast
F25	Engine Sounds
F26	Brake Sounds (On/Off)
F27	Cab Chatter (On/Off)
F28	Feature Reset

***Refer to pages 25-27 for
CV Data and Function ID**

CV29

CV29 is the basic decoder setup CV that is used by all DCC decoder manufactures. So, if you are familiar with CV29 from other manufacturer's decoders MTH's is no different. The most important part of CV29 is the ability to switch between long and short addressing. By default, CV29 on your MTH PS3.0-equipped engine is set to 2.

Long and Short Addressing

Like most DCC Decoders, your MTH PS3.0-equipped engine can be programmed with both Long and Short Address. Short addresses are those from 1-127 and Long addresses are those from 128-9999. You can program the engine address either with Programming on the Main (PoM) or using a Programming Track. Since it's easiest, in most cases, to PoM the instructions will show you how to do it this way. By default, your MTH PS3.0-equipped engine comes programmed with both a long and short DCC address. The default Short address is always 3. **The default Long address will be 3333.**

To change your engine's Short Address using PoM:

1. Call up the engine's current address on your DCC handheld
2. Enter Programming on the Main on your DCC handheld
3. Enter the new address you want – Remember you can only use address 1-127 for Short Addressing
4. Once you hit Enter the engine will give you a two whistle/horn blast response
5. Call up the engine on its new address and away you go.

Alternatively, depending upon the type of DCC system you have, you can enter PoM and then write the new address in the Address Menu. This only works for short addressing. For example, on an MRC Prodigy Advance2 system, you would:

1. Call up the engine's current address on your DCC handheld
2. Hit the PROG button twice to enter PoM mode
3. Hit Enter twice so the LCD displays "Adr"
4. Type in the new Short Address (1-127) that you want and hit Enter
5. The engine will give you a two whistle/horn blast response

To change your engine's Long Address using PoM:

1. Call up the current engine's address on your DCC handheld
2. Enter Programming on the Main on your DCC handheld
3. In this step you have to tell the MTH engine that you want it to start looking at long addresses. You do this in CV29:
 - a. Bring up the CV menu on your DCC handheld
 - b. Enter “29” to edit CV29
 - c. Enter “38” to change the value of CV29 and hit Enter
 - d. The engine will give you a two whistle/horn blast response
4. In the following steps you will now need to write values to CV17 and CV18 to tell the engine what the long address should be

Feature/Factory Resetting

Please note, when making setting changes in DCS or DCC, such as address, please wait a minimum of 5 seconds after removing power to insure the settings are stored in the engines memory. Reapplying power in less than 5 seconds may result in losing the setting changes. If all else fails and you aren't sure of something, never fear. You can always get your engine back to a known state by either performing a Feature or Factory Reset.

There are a couple of ways to reset your MTH PS3.0-equipped engine:

Factory Resets – Clears everything – takes engine to just like it was when you got it brand new

- Send a decimal 08 to CV 8 to reset everything entirely back to factory default
- Send a decimal 192 to reset everything except user speed tables

Feature Resets – There are a couple of Feature Resets that you can use

- Press F28 twice (toggling on then off). This resets the smoke, volume and lights back to their defaults
- Send a decimal 64 for a Feature Reset. This resets volumes, smoke and light settings.
- Send a decimal 128 to reset only address values back to factory default
 - This is the same as writing 55 to CV55 to engine address 55

Note: The engine address has to be something other than address 55

Lost or Unknown Engine Address and the 55-55-55 Address Reset

In some cases you may not remember or have somehow lost the engine address. Following the above Feature or Factory Resets will allow you to recover an engine. The limitation to this is that for most resets you must know the engine address. If you are unsure of the engine address you can apply the 55-55-55 reset (send a value of 55 to CV55 to engine address 55). In order for this to work correctly the engine's address must NOT be 55. The engine will need to be sitting at some address other than 55.

Below is the method (55-55-55 Reset) you can employ to return an engine to its factory default short address of 3 (it will also set the engine's long address back to its default – usually 3333 or the cab number on some models) if you're unsure of the engine's current address:

- Check first to see if the engine happens to be sitting at address 55. Call up engine 55 on your DCC handheld and hit F3 to start the engine up. If it starts up then you can change the address to whatever you want using CV1 (short address) or CV17 and CV18 (long address)
- If the engine doesn't start up at address 55 then you can use the 55-55-55 reset. To perform this follow the instructions below:
 - Ensure the DCC system is powered up and power is on the rails
 - Call up engine address 55. NOTE – you are NOT changing the engine's address to 55 you are just telling the DCC system to start talking to engine address 55. You will want to make sure that no other MTH engines are on the rails or any other manufacturer's engines with an address of 55 are on the rails. MTH engines will listen for commands coming to engine address 55 when the 55-55-55 reset is enabled even though they are not programmed as address 55
 - Enter PoM mode on your DCC handheld and write a value of 55 to CV55. Again, even though your MTH engine is NOT on address 55 it will still listen for this reset command
 - Call up address 3 on your DCC handheld and hit F3. The engine should now start-up

If you have performed the 55-55-55 reset and the engine still doesn't respond then place the engine on the programming track output of your DCC system and program a value of 3 to CV1. This will set the engine's short address to 3. However, as long as the engine is NOT programmed as address 55 then the 55-55-55 reset will always set the engine's long and short addresses back to their factory defaults. It will also set the engine's addressing back to short (if you happened to have CV29 set to long addressing)

The 55-55-55 Reset can be confusing at first but the main point to note is that you are NOT setting the engine's address to 55 to perform the reset, you are just calling up engine address 55 on your DCC handheld and sending a value of 55 to CV55. Again, MTH engine's will listen to the 55-55-55 reset command even though the engine's address isn't actually 55 (and it can't be for the 55-55-55 reset to work).

MTH PS3.0 Expanded DCC Functionality

Advanced DCC Operation

This section of the manual provides more in-depth detail on how to set up and configure your MTH PS3.0-equipped engine using the NMRA-standard CV's as well as the manufacturer-specific CV's. It also explains some of the other F Functions not covered in the Basic DCC Operation section.

Configuration Variables (CV)

Configuration Variables used on MTH PS3.0-equipped engines.

CV1	Short Address: 1-127 are the valid addresses
CV2	Start Voltage ¹
CV3	Acceleration Rate ¹
CV4	Deceleration Rate ¹
CV5	Max Voltage ¹
CV8	MFG ID. MTH =27 (Also used for various resets)
CV11	Packet Timeout
CV17	High Byte of Extended Address
CV18	Low Byte of Extended Address
CV19	Consist Address (bit 7=1 on an engine will tell the engine it's reversed in a consist)
CV21	Defines active Function F1-F8 for the active consist
CV22	Defines active functions for FL and F9-F12 for the active consist (bit 0=1 will tell an engine that you want it's FL control to operate under the consist address – bit1-0/bit2=1 will configure the FL control for a reversed engine in a consist)
CV23	Consist Acceleration Rate
CV24	Consist Deceleration Adjustment
CV25	Speed Table Select
CV29	Decoder Configuration
CV49	Short Address (controllers that prohibit PoM)
CV50	Extended Addr High Byte (controllers that prohibit PoM)
CV51	Extended Addr Low Byte (controllers that prohibit PoM)
CV52	MTH/PWM Mode Configuration
CV53	MTH Acceleration (1/8 *sMPH/s) (For example - a Value of 8 written would give you 1sMPH/s acceleration)
CV54	MTH Deceleration Rate (1/8*sMPH/s)
CV55	Factory Address Reset Alternate method. Send a value of 55 to CV55 on address 55 and the model will go back to the Factory Default Address. Note: The engine address has to be something other than address 55
CV56	Marklin Configuration
CV57	Anti-Jackrabbit Toggle. A value of 7 disables the feature, a value of 0 enables the feature.
CV63	MTH Consist Acceleration Rate (1/8*sMPH/s)
CV64	MTH Consist Deceleration Rate (1/8*sMPH/s)
CV66	Forward Trim ¹
CV67- CV94	Speed Table Selection (CV29 bit 4 must be set to 1 then CV25 must be set to 0 or 1)
CV95	Reverse Trim ¹
CV105	User ID #1 – General Purpose use for customer
CV106	User ID #2 – General Purpose use for customer
CV115- CV170	MTH Function Assignments – See table of supported CV's and manual section on how to re-arrange them for further information

1. CV52, bit0 must = 1. This will enable PWM Mode.

Factory Default Values for MTH PS3.0 DCC Configuration Variables (CV's)

Default Value	Range	Description	CV	F-Key	Description	CV
3	0-127	Short Address	1	1	Function - Bell High Byte	115
16	0-255	Start Voltage (Cv52 bit 0 must =1)	1	1	Function - Bell Low Byte	116
0	0-255	Accel Adjustment	2	2	Horn High Byte	117
0	0-255	Decel Adjustment	4	2	Horn Low Byte	118
0	0-255	Max Voltage (Cv52 bit 0 must =1)	5	3	Start-Up/Shut Down High Byte	119
0	-	NMRA Mfg Version	7	3	Start-Up/Shut Down Low Byte	120
27	-	NMRA Mfg ID	8	4	PFA High Byte	121
0	0-255	Packet Timeout	11	4	PFA Low Byte	122
205	192-231	Extended Address High Byte	17	5	Lights High Byte	123
5	0-255	Extended Address Low Byte	18	5	Lights Low Byte	124
0	0-255	Consist Address	19	6	Master Volume High Byte	125
0	0-255	Consist Functions F1-F8	21	6	Master Volume Low Byte	126
0	0-255	Consist Functions F9-F12	22	7	Front Coupler High Byte	127
0	0-255	Consist Acceleration Adjustment	23	7	Front Coupler Low Byte	128
0	0-255	Consist Deceleration Adjustment	24	8	Rear Coupler High Byte	129
0	0-127	Speed Table Select	25	8	Rear Coupler Low Byte	130
2	0-255	Decoder Configuration	29	9	Forward Signal High Byte	131
-	0-127	Short Address (controllers that prohibit PoM)	49	9	Forward Signal Low Byte	132
-	192-231	Extended Addr High Byte (controllers that prohibit PoM)	50	10	Reverse Signal High Byte	133
-	0-255	Extended Addr Low Byte (controllers that prohibit PoM)	51	10	Reverse Signal Low Byte	134
0	0-255	MTH PWM Motor Configuration	52	11	Grade Crossing High Byte	135
128	0-255	MTH Acceleration Rate	53	11	Grade Crossing Low Byte	136
64	0-255	MTH Deceleration Rate	54	12	Smoke On/Off High Byte	137
0	0-255	Marklin Configuration	56	12	Smoke On/Off Low Byte	138
0	0-255	Anti-Jackrabbt	57	13	Smoke Volume High Byte	139
0	0-255	MTH Consist Acceleration Rate	63	13	Smoke Volume Low Byte	140
0	0-255	MTH Consist Deceleration Rate	64	14	Idle Sequence 3 High Byte	141
0	0-255	Forward Trim	66	14	Idle Sequence 3 Low Byte	142
0	0-255	Alternate Speed Curve Step 1	67	15	Idle Sequence 2 High Byte	143
9	0-255	Alternate Speed Curve Step 2	68	15	Idle Sequence 2 Low Byte	144
19	0-255	Alternate Speed Curve Step 3	69	16	Idle Sequence 1 High Byte	145
28	0-255	Alternate Speed Curve Step 4	70	16	Idle Sequence 1 Low Byte	146
38	0-255	Alternate Speed Curve Step 5	71	17	Extended Start-Up High Byte	147
47	0-255	Alternate Speed Curve Step 6	72	17	Extended Start-Up Low Byte	148
57	0-255	Alternate Speed Curve Step 7	73	18	Extended Shut Down High Byte	149
66	0-255	Alternate Speed Curve Step 8	74	18	Extended Shut Down Low Byte	150
76	0-255	Alternate Speed Curve Step 9	75	19	Rev Up High Byte	151
85	0-255	Alternate Speed Curve Step 10	76	19	Rev Up Low Byte	152
94	0-255	Alternate Speed Curve Step 11	77	20	Rev Down High Byte	153
104	0-255	Alternate Speed Curve Step 12	78	20	Rev Down Low Byte	154
113	0-255	Alternate Speed Curve Step 13	79	21	One Shot Doppler High Byte	155
123	0-255	Alternate Speed Curve Step 14	80	21	One Shot Doppler Low Byte	156
132	0-255	Alternate Speed Curve Step 15	81	22	Coupler Slack High Byte	157
142	0-255	Alternate Speed Curve Step 16	82	22	Coupler Slack Low Byte	158
151	0-255	Alternate Speed Curve Step 17	83	23	Coupler Close High Byte	159
161	0-255	Alternate Speed Curve Step 18	84	23	Coupler Close Low Byte	160
170	0-255	Alternate Speed Curve Step 19	85	24	Single Horn Blast High Byte	161
179	0-255	Alternate Speed Curve Step 20	86	24	Single Horn Blast Low Byte	162
189	0-255	Alternate Speed Curve Step 21	87	25	Engine Sounds High Byte	163
198	0-255	Alternate Speed Curve Step 22	88	25	Engine Sounds Low Byte	164
208	0-255	Alternate Speed Curve Step 23	89	26	Brake Sounds On/Off High Byte	165
217	0-255	Alternate Speed Curve Step 24	90	26	Brake Sounds On/Off Low Byte	166
227	0-255	Alternate Speed Curve Step 25	91	27	Cab Chatter On/Off High Byte	167
236	0-255	Alternate Speed Curve Step 26	92	27	Cab Chatter On/Off Low Byte	168
246	0-255	Alternate Speed Curve Step 27	93	28	Feature Reset High Byte	169
255	0-255	Alternate Speed Curve Step 28	94	28	Feature Reset Low Byte	170
0	0-255	Reverse Trim	95			
0	0-255	User ID #1	105			
0	0-255	User ID #2	106			

User-Settable F-Function List

This feature allows you to take the 28 F-Functions that currently reside in each MTH Proto-Sound 3.0-equipped O-Gauge Engine and change the location of that function. For example: F4 is currently PFA and you'd like that placed down to F28 which is Feature Reset. The below instructions explain how you can do this.

Note – When you set a particular F-Function to a numeric location you are overwriting that existing number's function. Further, you are leaving the location where the previous function was moved from empty, which means that F-Function no longer has any function associated with it

In order to move the F-Functions around you will need to refer to the below table.

Note: The Function Identification number IS NOT the F Function number you would use on your DCC handheld. It is used internally in the engine.

Function Identification Chart

SOUNDS	FUNCTION IDENTIFICATION	OTHER FUNCTIONS	FUNCTION IDENTIFICATION
Bell	1	Feature Reset	29
Brake Sounds	2	Front Coupler	30
Cab Chatter	3	Front Pantograph	
Clickety Clack	4	Up/Down	31
Coupler Close	5	Pantograph	
Coupler Slack	6	Auto/Manual	32
Drift Chuff	7	Rear Coupler	33
Engine Sounds	8	Rear Pantograph	
Forward Signal	9	Up/Down	34
Grade Crossing Signal	10	Rev Down	35
Horn	11	Rev Up	36
Idle Sequence 1	12	Smoke On/Off	37
Idle Sequence 2	13	Smoke Volume	38
Idle Sequence 3	14		
Idle Sequence 4	15	MOTOROLA MODE	
Labor Chuff	16	Disable Momentum (Motorola)	40
Master Volume	17	Half-Speed (Motorola)	41
Short Horn	18	Switch—Half-Speed/	
One Shot Doppler	19	Momentum Disable (Motorola)	42
Reverse Signal	20		
		LIGHTS	
SCRIPTS		Lights	39
Extended Shut Down	21	Marker (Train/No Train)	43
Extended Start Up	22	Beacon	
PFA	23	(Alt Lighting/Country)	44
Start Up/Shut Down	24		
Train Wreck	25	ELECTRIC SMOKE	
Trolley Manual Mode	26	Electric Boiler Start-Up	45
Trolley Learn Mode	27	Electric Pressure Release	46
Trolley Auto Mode	28		

The above list includes ALL F functions that an MTH PS3 engine could have. You are free to change any of the above listed items to any F function position, 1-28. For example, if you your engine came from the factory without a smoke unit but you added one at a later date you could swap out any of the F functions, 1-28, for the Smoke On/Off and the Smoke Volume.

So, using the example above of moving F4 to F28 here are the steps:

1. Refer the MTH Supported CV table to see what CV the destination Function is assigned to. In doing so, you are looking only for the Low Byte CV location. In this case it's CV170
2. Using your DCC system, bring up CV programming for CV170
3. Now tell the engine which F-Function you want to write at CV170. So, looking at the Function ID table above you can see that PFA is a value of 23
4. Using your DCC system, enter a value of 23 for CV170 and hit Enter. You have just re-assigned the PFA sound to F28 on your DCC controller. The engine will give you a two horn blast indication. Note – You've also left an empty location where PFA used to be (F4)
5. Now you can fill that location with whichever CV you'd like. For this example we are just going to move the Feature Reset up to F4 (we're just swapping F4 and F28)
6. Since F4's Low Byte is CV122 then bring up CV programming for CV122
7. Now tell the engine which F-Function you want to write at CV122. So, looking at the Function ID table above you can see that Feature Reset is a value of 29
8. Using your DCC system, enter a value of 29 for CV122 and hit Enter. Your engine will give you a two horn blast indication

Custom Speed Tables

Below is a table that shows the value to write to CV25 to achieve the desired speed curve. For example, if you would like to use speed curve 18 then:

1. Write a value of 1 to CV52 to enable PWM Mode
2. Write a value of 1 to bit 4 of CV29
3. Write a value of 18 to CV25. Your engine will now use the speed curve #18 below
4. If you want to create your own speed table using CV's 67-94 then write a value of 0 or 1 to CV25

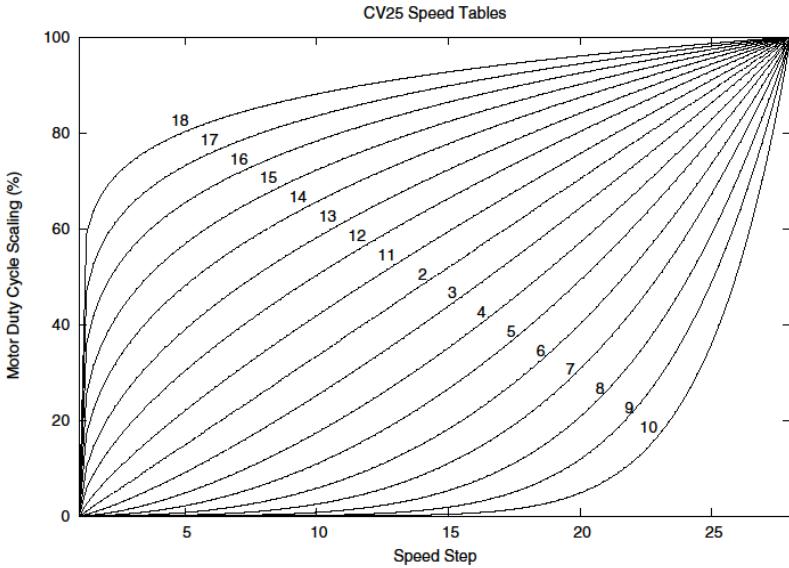

Advanced Consisting

Advanced Consisting follows the NMRA standards. Any values assigned to CV's 21-24 are ignored once the consist is removed (CV19 set to 0).

- Setting the MSB (Bit 7) of CV19 tells the engine that it is facing reverse in the consist
- Setting CV21 and CV22 determine which F Functions the consist responds to

See diagram below for example

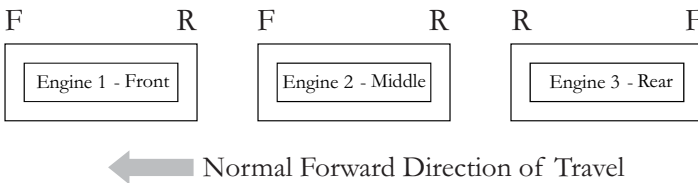

To set this consists up so that:

- The Headlight is ON in the Front engine when going Forward, OFF when the consist is in Reverse
- The Reverse light and headlight is OFF in the Rear engine when the consist is going Forward, headlight is ON, reverse light is OFF when the consist is in Reverse
- The Middle engine has no lights in either direction

Perform the following:

1. Build the consist using your DCC system per the DCC system's manufacturer's instructions. In many newer systems you have the ability to tell the system which engine is reversed. Remember the consist address you told the DCC system to be built at as you'll need to come back to that address to actually run the consist. The instructions assume only CV19 gets the consists address and nothing more
2. Call up the Front engine on your DCC handheld; address 1 in this example
3. Select CV22 and write a value of 1. This tells the engine that it's a forward facing engine and that you want F0 to control the FL function at the consist address. The engine will give you two horn blasts to announce that it received the CV change
4. Ensure F0 is deactivated at the Front engine's address. Most systems have a light bulb icon to indicate whether F0 is active or not. Ensure that it is OFF
5. Call up the Rear engine on your DCC handheld; address 3 in this example
6. Set CV19 to $128 +$ the value of your consist address
 - So, if your consist address is 4 you would add $128+4=132$. You would write 132 to CV19. This tells the Rear engine that it's reversed in the consist. You will get two horn blasts to announce that it received the CV change. Some DCC systems may already do this for you but the instructions assume your system does not. If you are in doubt then go ahead and follow step 5 as it will do no harm
7. Set CV22 to a value of 2 to the Rear engine's address to tell the Rear engine that you want to control its FL control with the F0 button at the consist address. The engine will give you two horn blasts to announce that it received the CV change
8. Ensure F0 is deactivated at the Rear engine's address. Most systems have a light bulb icon to indicate whether F0 is active or not. Ensure that it is OFF
9. Call up the Middle engine on your DCC handheld; address 2 in this example
10. Ensure F5 and F0 are toggled OFF. You may have to toggle F5 on/off a couple times to get the lights in sync with the DCC command station. This will depend upon your DCC system

11. Call up the consist address (address 4 in this example)
12. Press the F0 button to ensure the FL is toggled on. Most systems have a light bulb icon to indicate whether F0 is active or not. Ensure that it is ON

NOTE: The convenient thing about setting up the consist as described above is that it allows you flexibility in the orientation of an engine in a consist; particularly the head and tail engines where the FL control is integral. For example, if you wanted to flip the Rear engine around and make it face forward in the consist all you'd have to do is go into the Rear engine's address (address 3 in the example) and clear bit 7 of CV19. In other words, just write the consist's address to CV19. The FL control will automatically understand what you've done so there is no need to go in and change CV22.

Below is a table that outlines which bits correspond to what F Functions F0, F9-F12 are used in a consist:

Bit (Decimal Value)	7 (128) Not Used	6 (64) Not Used	5 (32)	4 (16)	3 (8)	2 (4)	1 (2)	0 (1)
F Function	Not Used	Not Used	F12	F11	F10	F9	F0 (Engine Facing Rev)	F0 (Engine Facing Fwd)

Setting Up CV21 for a Consist

CV21 allows you to set which F Functions you want the consist address to control. For example, you will likely want all of your MTH consist engines to respond to Start-Up/Shut Down (F3). Also, you'll likely want at your Front engine to respond to the Bell and Horn commands (F1 and F2, respectively) and the Front Coupler (F7 on most MTH models). Likewise, you'll want your Rear engine to respond to the Rear Coupler command (F8 on most MTH models).

Please refer to the table below to see which bits have what decimal value and which F Function they correspond to.

To do this:

1. Call up the Front engine on your DCC system
2. To set the Front engine to respond to the Bell (F1), Horn (F2), Start-Up/Shut Down (F3) and Front Coupler (F7) you will want to write a value of 71 to CV21. This is setting bits 0, 1, 2, and 6 ON.
 - a. CV21's bits are shown in the table below – the decimal value is shown in parenthesis:

Bit (Decimal Value)	7 (128)	6 (64)	5 (32)	4 (16)	3 (8)	2 (4)	1 (2)	0 (1)
F Function	F8	F7	F6	F5	F4	F3	F2	F1

NOTE: CV21 is ONLY used when you have some value other than 0 written to CV19. If CV19 = 0 then the values of CV21, CV22, CV23, and CV24 are not used

3. Call up your Middle engine (address 2 in the example)
4. Since you want to have the Middle engine respond to F3 only then write a value of 4 (CV21, bit 2 = ON)
5. Call up your Rear engine (address 3 in the example)
6. Since you want to have the Rear engine respond to the Start-Up/Shut Down (F3) and Rear Coupler (F8) functions you want to write a value of 132 to CV21

Your engines are now set up according to the example above.

You will note that there is no F0 in CV21. This is because that function (FL) is controlled by CV22. Please refer to the Advanced Consisting section for more information regarding CV22.

Programming Track

Your MTH PS3.0-equipped engine can function on Programming Track outputs from DCC systems. Because each DCC system manufacturer's output capabilities on the Programming Track differ it is recommended that you use a DCC Programming Track Booster to perform functions on the programming track. Simply put – try to program or read back the address of an MTH engine on a programming track. If you can read/write the address then you won't need a Programming Track Booster. If your DCC system can't read/write then you will likely need a Programming Track booster. There are a few different manufacturers of these boosters. Your local dealer can provide you with more information on these boosters. MTH has used the DCC Specialties Power Pax with some success.

NOTE: An alternative to writing on a Programming Track is to simply Program on the Main (PoM). MTH engines support PoM to write any CV on the main. However, read back is not supported on the main. Check with your DCC system's manufacturer to see about any limitations they may have to PoM.

DCC Bit Value Decoder

Example Value (bit 7 -> bit 0) 11011001								
Bit (Decimal Value)	7 (128)	6 (64)	5 (32)	4 (16)	3 (8)	2 (4)	1 (2)	0 (1)
Binary Example	1 (on)	1 (on)	0 (off)	1 (on)	1 (on)	0 (off)	0 (off)	1 (on)
Decimal Value	128	64	0	16	8	0	0	1

So, in the above example you simply add up the values in the “Decimal Value” row – $128+64+0+16+8 +0+0+1 = 217$. You would write 217 to the CV you were altering.

The above applies to any CV. Also, if you have a CV that already has a value assigned that you do not want to alter but need to make additions to it, for example CV29, you would simply add the additional bits you enabled to the existing value to obtain the new CV value.

For example, if you had a consist address (CV19) set to 5 and you wanted to alter this to show an engine reversed in the consist you would need to set bit 7 (decimal value = 128) for the engine you want to reverse. To do this - take 128 (the new bit you want to set) + 5 (the existing bit that you do not want to alter) = 133. You would then write a value of 133 to CV19.

Maintenance

Lubricating and Greasing Instructions

The engine should be well oiled and greased in order to run properly.

Regularly lubricate all side rods, linkage components and pickup rollers to prevent them from squeaking. Use light household oil and follow the lubrication points marked “L” below. Do not over-oil. Use only a drop or two on each pivot point.

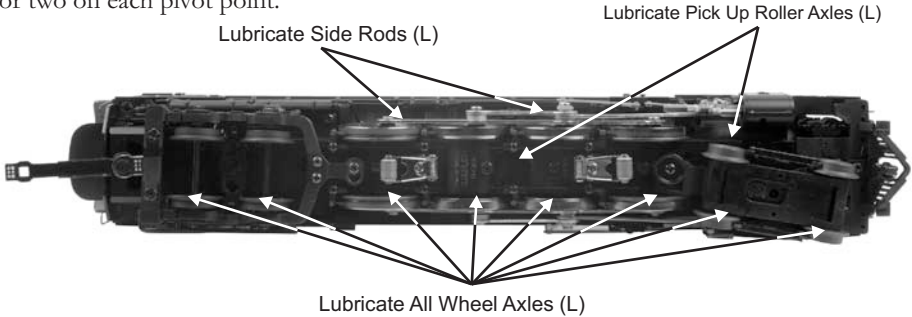

Fig. 9: Lubricating the Locomotive

The locomotive’s internal gearing was greased at the factory and should not need additional grease until after 50 hours of operation or one year, whichever comes first. Remove the grease port screws and use a grease tube dispenser to put a small amount (approx. 1-2 mL.) of lithium-based grease into each grease port. Wipe off any excess grease and replace the screws securely.

Use the diagram shown in Figure 10 below as a guide and add grease to the points marked.

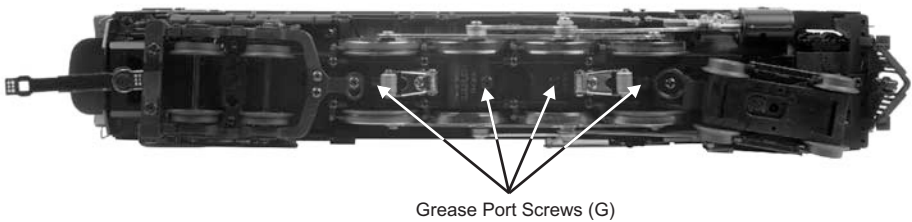

Figure 10: Grease Points

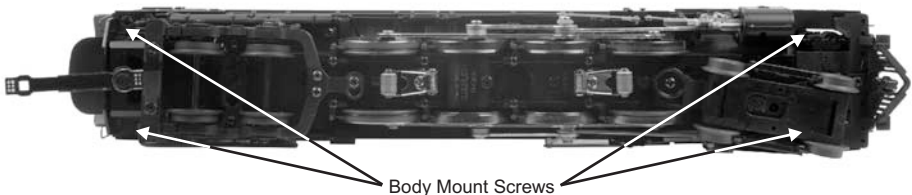

Figure 11: Removing the Body

Cleaning The Wheels, Tires, and Track

Periodically check the locomotive wheels and pickups for dirt and buildup, which can cause poor electrical contact and traction and prematurely wear out the neoprene traction tires. Wheels and tires can be cleaned using denatured (not rubbing) alcohol applied with a cotton swab.

To clean the track, use RailKing® Track Cleaning Fluid or denatured (not rubbing) alcohol and a clean rag. Unplug the transformer and wipe the rails of the track, turning the rag frequently to ensure that you are using clean cloth on the rails. Thereafter, keep an eye on the track and clean it when it gets dirty to ensure good electrical contact and to lengthen the life of the tires.



Clean any type of track with this heavy-duty track cleaning block (40-1099). Durable constructed from ABS plastic, the block includes a built-in cleaning pad. For really stubborn track, you can insert sandpaper into the block in just a few quick steps.



Maintenance Kit (30-50051)



Track Cleaning Block (40-1099)

Traction Tire Replacement Instructions

Your locomotive is equipped with two neoprene rubber traction tires on the rear set of flanged drivers. While these tires are extremely durable, they may occasionally need to be replaced.

- Remove the side rods (the rods that connect each drive wheel to the other) from the wheels in order to slip the new tire over the grooved drive wheel. These bolts can be loosened with a 5mm nutdriver.
- Clean the groove using a cotton swab and denatured alcohol
- Make sure the old tire has been completely removed from the groove in the drive wheel, using a razor blade or small flathead screwdriver to pry away any remains.

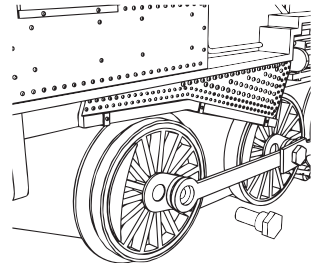

- Clean the groove using a cotton swab and denatured alcohol.
- Slip the new tire onto the wheel. You may find it useful to use two small flathead screwdrivers to stretch the tire over the wheel.
- If you twist the tire while stretching it over the wheel, you will need to remove and reinstall the tire. Otherwise your engine will wobble while operating.
- Make sure the tire is fully seated inside the groove. Use a razor blade to trim away any excess tire that doesn't seat itself inside the groove properly.

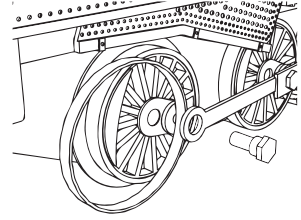

ProtoSmoke™ Unit Operation

This steam locomotive contains a smoke unit that outputs smoke through the smokestack on the boiler of the engine. The smoke unit is essentially a small heating element and wick that soaks up and then heats a mineral oil-based fluid that emits a harmless smoke. The smoke is then forced out of the stack by a small electric fan. With a few easy maintenance steps, you should enjoy trouble-free smoke unit operation for years.

- When preparing to run this engine, add 15-20 drops of smoke fluid through the smokestack. We recommend M.T.H. ProtoSmoke fluid (a small pipette of ProtoSmoke fluid is included). Do not overfill the unit or the fluid may leak out and coat the interior engine components.
- If you choose not to add the fluid (or have already added the fluid but choose to run smoke-free), turn off the smoke unit control (Full Counter Clockwise Position) located under the tender body. **Failure either to add fluid to the unit or to turn it off may damage the smoke unit heating element and/or wicking material.**
- When the smoke output while running the engine begins to diminish, add another 10-15 drops of smoke fluid or turn the smoke unit off.
- When storing the unit for long periods of time, you may want to add about 15 drops of fluid to prevent the wick from drying out.



Figure 12: Adding Fluid



Headlight Replacement Instructions

The PS 3.0 headlights and other associated lights are small LEDs that require a lot less power and generate a lot less heat than incandescent bulbs, resulting in extremely long life compared to the incandescent bulbs. The LEDs are not user serviceable

Troubleshooting Proto-Sound® 3.0 Problems

Although Proto-Sound® 3.0 has been designed and engineered for ease of use, you may have some questions during initial operation. The following table should answer most questions. If your problem cannot be resolved with this table, contact M.T.H. for assistance (telephone: 410-381-2580; fax: 410-423-0009; service@mth-railking.com, 7020 Columbia Gateway Drive, Columbia MD 21046-1532).

Conventional AC

Starting Up	Solution
Only my headlight comes on, nothing else.	This is normal behavior. The super capacitors are charging and this will take between 1-20 seconds. (see page 8 for more details)
When I first turn the power on, the engine will not begin to run.	This is normal behavior. To prevent accidental high-speed start-ups, Proto-Sound® 3.0 is programmed to start up in neutral anytime track power has been turned off for several seconds. See the "Basic Operation" section for more details.
The engine will not start after I press the Direction button.	You may not be sending enough power to the track to power the engine. Rotate throttle to increase track power.
Horn	Solution
I can't get the whistle to blow when I press the Whistle button.	You may be pressing the button too quickly. Try pressing the Horn/Whistle button more slowly, taking approximately one full second to fully depress the button.
Bell	Solution
I can't get the bell to ring when I press the bell button.	You may be pressing the button too quickly. Try pressing the bell button more slowly, taking approximately one full second to fully depress the button.
Coupler	Solution
When I try to fire the coupler, PFA starts.	You are waiting too long between Horn/Whistle button presses. See the timing instructions located at the beginning of the "Proto-Sound® 3.0 Operating Instructions" section.
The Proto-Coupler™ won't let the engine uncouple on the fly.	Try lubricating the coupler knuckle and rivet with a dry graphite lubricant.
The coupler does not fire or stay coupled.	The coupler needs to be cleaned. Wipe with denatured alcohol (not rubbing alcohol) and let dry.
Cab Chatter	Solution
Sometimes the Cab Chatter sounds don't play.	Cab Chatter plays only in neutral at random intervals.

Lock-out	Solution
<p>I can't get the engine to run after I power up the transformer. It sits still with the steam sounds and compressor sounds running. The engine won't lock into forward, neutral, or reverse.</p>	<p>The engine maybe locked into the neutral position. Follow the procedure in the "Lock into a Direction" section to unlock the engine's direction. Engine speed must be below 10 scale mph (approx. 10 volts or less in conventional mode).</p>
Volume	Solution
<p>The sounds seem distorted, especially when the Horn/Whistle or bell is activated.</p>	<p>Proto-Sound® 3.0 volume is set too high. Turn the volume control knob on the bottom of the tender counter-clockwise to reduce the volume.</p>
<p>No Sound</p>	<p>Volume is set too low, adjust volume control knob on the bottom of the chassis clockwise to increase the volume or check connector to speaker.</p>
PFA	Solution
<p>Once in PFA, the engine doesn't go into reverse.</p>	<p>So that PFA effects can be as realistic as possible, Proto-Sound® 3.0 disables the reversing unit whenever PFA is enabled. This way the engine remains still at its stop as the operator cycles through the PFA sequences.</p>
<p>When the PFA enters its last sequence the bell automatically comes on.</p>	<p>PFA is programmed to start ringing the bell at that point. After approximately 12 seconds, it will automatically turn off.</p>
<p>When PFA is enabled, pressing the Horn/Whistle and bell button has no effect.</p>	<p>Because PFA must control various effects in each sequence, Proto-Sound® 3.0 takes control of these sound effects until you exit PFA</p>
<p>I push the direction button but the next sound clip in the sequence does not play or the engine does not come out of PFA after fourth press of the direction button.</p>	<p>Each PFA clip must play for aprox. 30 seconds before PFA will advance to the next step in the PFA cycle. Wait at least 30 seconds in each PFA sound clip before pressing the direction button.</p>

Conventional DC

Start-up	Solution
When I apply power to the track my engine doesn't do anything. No lights, no sound, no nothing.	Check to see if that section of track has power Use a voltmeter or a lit passenger car.
	Slide the engine a couple of feet in either direction, you may have a bad track section
	Have you got that section electrically isolated with a toggle switch or other device?
Sound	Solution
I have no sound from my engine, but my lights are on and it moves just fine.	Check the volume pot on your tender. Full CW = Max volume
There's a crackling sound from my engine	Check to see if a screw or some other material hasn't lodged itself in the underside of the chassis or tender
	Make sure smoke volume pot is turned full CW
Smoke	Solution
My engine isn't smoking at all	Make sure smoke volume pot is turned full CW
	If you just filled it with smoke fluid sometimes the fluid can make a seal in the stack. Blow down the stack to clear the air bubble
	Check the Tender/Boiler drawbar connection. You've got to have them locked together
My engine's smoke output is low	If you've been running your engine in DCS or DCC mode the smoke may have gotten set to Low or Med. With the engine running in DCS or DCC set the smoke back to High. It'll remember what you last set it as when you run it again in Conventional DC
	Check for an obstruction in the smoke stack
	Add 10-12 drops of smoke fluid

Lights	Solution
One of my lights is out.	Most likely you had been running the engine in DCC or DCS mode and toggled that light off. Put it back into one of those modes and turn that light back on. The engine will remember that when you run it again in Conventional DC.
None of my lights are on.	Could be the same reason as "One of my lights is out"
	Is the engine getting power? Check to see if there is voltage on the track or move the engine a few feet in either direction.
Motion	Solution
When I apply power to the track my engine starts up (lights and sound) but it won't move	Lower the track voltage then raise it again. The engine should start moving. If you apply greater than 9VDC quickly the engine will just sit there. Lowering it below 9VDC then raising it will get the engine moving.
My engine hesitates at slow speeds.	An engine may do this right out of the box if it has not been lubricated. Follow the lubrication instructions. Now go ahead and run it.
	New engines even after they are lubricated may take a little bit to get everything run in. Be a little patient and let it run for a bit. It should clear up shortly after lubricating and running.

DCC

Start-up	Solution
When I apply power to the track my engine doesn't do anything. No lights, no sound.	Did you press F3 yet? F3 on your DCC handheld will start your engine up.
	Check to see if that section of track has power. Use a voltmeter or a lit passenger car, not your tongue.
	Slide the engine a couple of feet in either direction, you may have a bad track section.
	Have you got that section electrically isolated with a toggle switch or other device?
Sound	Solution
I have no sound on my engine, but my lights are on and it moves just fine.	You may have it turned off. Repeatedly press F6 to cycle through the volume levels (there are 9 levels, 0-max).
There's a crackling sound from my engine	Check to see if a screw or some other material hasn't lodged itself in the underside of the engine.
When I run Doppler I can hear the Doppler shift but then the engine sounds fade out and I can't get them back.	This is normal. You will need to press the F21 button again to turn Doppler off. Your engine sounds will now return to normal.
Smoke	Solution
My engine isn't smoking at all.	Make sure you've got the smoke switch ON. It must be ON for the smoke to operate in DCC Mode.
	Press F12 on your DCC handheld. This will activate the smoke.
	If you just filled it with the smoke fluid sometimes the fluid can make a seal in the stack blow down the stack to clear the air bubble.
My engine barely smokes.	You may have set the smoke to Low. F13 will vary the smoke levels. Or, if you were running it in DCS mode you may have toggled it there (if you don't have F13 on your DCC handheld you will have to put it back into DCS mode and change it from there), or follow the instructions starting on pg. 27 to move the smoke volume into an F Function that exists on your controller
	Check for an obstruction in the smoke stack
	Add 10-12 drops of smoke fluid

Lights	Solution
One of my lights is out.	Check your F keys. F0 is the headlight (also controls the Back-up light) and F5 will toggle the Cab light and firebox light.
None of my lights are on.	Could be the same reason as "One of my lights is out"
	Is the engine getting power? Check to see if there is voltage on the track or move the engine a few feet in either direction.
Motion	Solution
When I apply power and hit F3, my engine powers up but it won't move.	This is normal, dial up the speed on your DCC controller to make your engine move.
My engine hesitates at slow speeds.	An engine may do this right out of the box if it has not been lubricated. Follow the lubrication instructions. Now go ahead and run it.
	New engines even after they are lubricated may take a little bit to get everything run in. Be a little patient and let it run for a bit. It should clear up shortly after lubricating and running.
PFA	Solution
I hit F4 to start the PFA but the engine just keeps ringing its bell, that's all it'll do.	Bring the engine speed to 0. Now press F4. You will now hear the station arrival or freight yard sounds (pretty cool, huh?). Pressing F4 will cycle through the PFA sequences (check out the PFA section of the manual for more)
Shut Down	Solution
Okay, I give up. What do I have to do to shut it down?	Well, you can either remove power from the track or press F3 again.
Lost or Unknown Address	Solution
I can't call up my engine on the address I believe it to be set at	Perform the 55-55-55 Reset instructions on page 24
	If you are trying to talk to an engine on its short address you may have set CV29 to activate long addressing. Try to get a hold of the engine on its last known long address
	Place the engine on the Programming Track output on your DCC system and write a value of 3 to CV1

DCS (Remember, it's NOT DCC)

Start-up	Solution
When I apply power to the track my engine doesn't do anything. No lights, no sound.	This is normal. You have to hit the Start-Up button.
	Check to see if that section of track has power. Use a voltmeter or a lit passenger car, not your tongue.
	Slide the engine a couple of feet in either direction, you may have a bad track section
	Have you got that section electrically isolated with a toggle switch or other device?
I get an error when I hit Start-Up	Have you recently changed the engine address?
	Check if there is power on that section of track the engine is sitting on (there has to be power for the signal to get to the engine and for the engine to be able to hear it)
DCS is polarity sensitive when powered by a DC power supply.	Check the polarity of the DC power supply connected to the Fixed 1 or Fixed 2 Inputs. Shut down power, reverse the inputs and repower DCS. Hitting the startup button on the DCS remote should start up the engine.
	If you have two engines on the track they both may have the same address. Take one of them off the rails and try it again
Sound	Solution
When I press the Whistle Button on my DCS remote or DCS commander the whistle doesn't blow	Check if the playable whistle is active. On the DCS Commander there will be two dashes on the right side of the LCD if it's active. Press "A1" twice to ensure it's turned off. On your DCS remote press the "SPW" button twice to ensure it's disabled
I have no sound on my engine, but my lights are on and it moves just fine	You may have it turned off. Repeatedly press VOL + to bring the Master Volume up
	Did you turn off the ENG Sounds? Press the ENG SND button on your DCS controller.
	Check that you haven't lowered any of the independent engine volumes (Eng Sounds, Bell, Whistle, or Accent)
There's a crackling sound from my engine	Check to see if a screw or some other material has lodged itself in the underside of the engine.
When I run Doppler I can hear the Doppler shift but then the engine sounds fade out and I can't get them back	This is normal. You will need to press the Doppler button again to turn Doppler off. Your engine sounds will now return to normal

Smoke	Solution
My engine isn't smoking at all	Press the smoke button, this will activate the smoke
My engine barely smokes	If you just filled it with the smoke fluid sometimes the fluid can make a seal in the stack. Blow down the stack to clear the air bubble.
	You may have set the smoke to Low. This can be changed from Low to Med to High.
	Check for an obstruction in the smoke stack
	Add 10-12 drops of smoke fluid
Lights	Solution
One of my lights is out.	Check that you haven't turned it off with the DCS controller. You have independent control over lights on your engine
None of my lights are on.	Could be the same reason as "One of my lights is out"
	Is the engine getting power? Check to see if there is voltage on the track or move the engine a few feet in either direction.
Motion	Solution
When I apply power and hit Start-up, my engine powers up but it won't move.	This is normal, dial up the speed on your DCS Remote to make your engine move.
My engine hesitates at slow speeds.	An engine may do this right out of the box if it has not been lubricated. Follow the lubrication instructions. Now go ahead and run it.
	New engines even after they are lubricated may take a little bit to get everything run in. Be a little patient and let it run for a bit. It should clear up shortly after lubricating and running.
PFA	Solution
When I enter PFA all that happens is the bell rings. What do I do?	Press the DIR button. Your engine will stop and begins the arrival sequence. Pressing the DIR button will cycle you through the next 3 PFA sequences
Why does my engine run away all by itself after the PFA is over?	This is normal. The engine will leave the station at the same speed it entered (when hit the PFA button). The speed setting can be changed after the bell stops ringing.
Shut Down	Solution
Okay, I give up. What do I have to do to shut it down?	Well, you can either remove power from the track or press or press Shut-Down. Button on the DCS Remote
Lost or Unknown Address	Solution
I can't call up my engine on the address I believe it to be set at	Delete the engine from your DCS remote, and attempt to re-add it.
	On the DCS Remote, hit Menu→System→Engine Setup→Recover Engine

Transformer Compatibility and Wiring Chart

Proto-Sound® 3.0 is designed to work with most standard AC transformers. The chart below lists the many compatible transformers. Note that many of the operational commands described in these instructions require a bell button, so if your transformer does not have its own bell button, you should consider adding one to get the full benefit of the system. In addition, the chart details how the terminals on these transformers should be attached to your layout.

RECOMMENDED AC TRANSFORMERS					
Transformer Model	Center Rail	Outside Rail	Min/Max. Voltage	Power Rating	Transformer Type
MTH Z-500	Red Terminal	Black Terminal	0-18v	50-Watt	Electronic
MTH Z-750	Red Terminal	Black Terminal	0-21v	75-Watt	Electronic
MTH Z-1000	Red Terminal	Black Terminal	0-21v	100-Watt	Electronic
MTH Z-4000	Red Terminal	Black Terminal	0-22v	390-Watt	Electronic
Lionel 1032	U	A	5-16v	90-Watt	Standard
Lionel 1032M	U	A	5-16v	90-Watt	Standard
Lionel 1033	U	A	5-16v	90-Watt	Standard
Lionel 1043	U	A	5-16v	90-Watt	Standard
Lionel 1043M	U	A	5-16v	90-Watt	Standard
Lionel 1044	U	A	5-16v	90-Watt	Standard
Lionel 1053	U	A	8-17v	60-Watt	Standard
Lionel 1063	U	A	8-17v	60-Watt	Standard
Lionel LW	A	U	8-18v	75-Watt	Standard
Powermaster	U	A	8-18v	135VA	Electronic
All-Trol	Left Terminal	Right Terminal	0-24v	300-Watt	Electronic
Dallee Hostler	Left Terminal	Right Terminal			Electronic
Lionel LW	A	U	8-18v	75-Watt	Standard
Lionel KW	A or B	U	6-20v	190-Watt	Standard
Lionel MW	Outside Track Terminal	Inside Track Terminal	5-16v	50V.A.	Electronic
Lionel RS-1	Red Terminal	Black Terminal	0-18v	50V.A.	Electronic
Lionel RW	U	A	9-19v	110-Watt	Standard
Lionel SW	U	A	Unknown	130-Watt	Standard
Lionel TW	U	A	8-18v	175-Watt	Standard
Lionel ZW	A,B,C or D	U	8-20v	275-Watt	Standard
Lionel Post-War Celebration Series ZW	A,B,C or D	Common	0-20v	135/190 Watt	Electronic

DC Power Supply Chart

RECOMMENDED DC TRANSFORMERS				
Transformer Model	Min/Max. Voltage	Power Rating	Notes On Use	Transformer Type
MRC 6200	0-18.5v	60-Watt	Not Recommended For #70-3001-1 J3a	Electronic
MRC Controlmaster 20	0-20v	100-Watt		Electronic
PH Hobbies PS5	0-20v	100-Watt		Electronic
PH Hobbies PS10G	0-20v	180-Watt		Electronic
Bridgeworks Magnum 15	0-24v *	300-Watt		Electronic
Bridgeworks Magnum 200	0-24v *	300-Watt		Electronic
Bridgeworks Magnum 400	0-24v *	300-Watt		Electronic
Bridgeworks Magnum 1000	0-24v *	300-Watt		Electronic
LGB Jumbo #50101	0-24v *	240-Watt	Not recommended for #70-3001-1 J3a	Electronic
Crest CRE-55460 Power Supply w/ CRE-55401 Controller	18VDC on Supply, 0-18VDC at Controller	180-Watt	FOR ANALOG DC OPERATION ONLY Controller has PWM Output from Fixed DC Input DO NOT Use with the DCS System (TIU) PWM Output from this power supply Will DAMAGE the TIU	Electronic

* Use 22 volts maximum track voltage when operating a MTH locomotive equipped with Proto-Sound, Loco-Sound, Proto-Sound 2.0, or Proto-Sound 3.0

Additional Features Accessible with the DCS Remote Control System

(Additional equipment required)

While conventional mode operation of a Proto-Sound® 3.0 engine yields wonderfully realistic sound and several train control features, command mode operation allows the user to access a world of command functions never before accessible to O Gauge railroaders. With the addition of the DCS Remote Control System (including a DCS remote handheld and Track Interface Unit) users gain many advanced features, including:

- DCS Proto-Speed Control - Establishes desired locomotive speed in scale miles per hour increments via a thumbwheel control and allows operator to set maximum speed and acceleration/deceleration rates
- ProtoSmoke™ Variable Output Control - Controls how much smoke each engine outputs and matches smoke to locomotive speed
- Locomotive Lighting Control - Controls locomotive headlights, marker and interior lights, beacon lights, ditch lights, and MARS lights
- Emergency Stop-Single button push stops all Proto-Sound® 2.0 and Proto-Sound® 3.0 engines but does not turn off the input power to the TIU
- One Touch Global Mute/UnMute-Single button mutes or unmutes all DCS-controlled locomotives' sounds
- Proto-Dispatch Operation-Public Address-like feature allows users to speak through locomotive speaker during operation
- Proto-Cast-Allows users to play audio recordings through locomotive speaker during operation
- Proto-Doppler Sound Effects Set Up-Users can configure locomotive for Doppler Operation, including setting distance points for Doppler start, repeat, and stop modes
- Independent Volume Control of Engine Sounds, Bell, Horn & Whistle, and Accent Sounds for each Locomotive
- Control up to 99 different DCS-Equipped Locomotives at one time with multiple TIUs
- Proto-Effects™ Set Up-User can select individual Proto-Effects™ operations to be active or inactive, including cab chatter, train wreck sounds, coupler sounds, Direction Control Set Up-User can set initial individual start-up direction (start in forward or reverse) for double-heading operations
- Locomotive Consist Set-up-User can determine locomotive values for consist make-ups, allowing multiple locomotives belonging to a consist to operate together

Service & Warranty Information

How to Get Service Under the Terms of the Limited One-Year Warranty

When you suspect an item is defective, please check the operator's manual for standard operation and troubleshooting techniques that may correct the problem. Additional information may be found on the M.T.H. Website. Should you still require service, follow the instructions below to obtain warranty service. First, e-mail, write, call or fax a M.T.H. Authorized Service Center (ASC) in your area to obtain Repair Authorization. You can find the list of ASCs on the M.T.H. Website, www.mthtrains.com. Authorized Service Centers are required to make warranty repairs on items sold only from that store; all other repairs may-- or may not be done at the store's own discretion. If you did not purchase the item directly from the ASC, you will need to select a National Authorized Service Center (NASC). These centers are compensated by M.T.H. to perform warranty service for any customer whose repair qualifies for warranty service. A list of NASC retailers can be located on the M.T.H. Website or by calling 410-381-2580. Should the warranty no longer apply, you may choose either an ASC or NASC retailer to service your M.T.H. Product. A reasonable service fee will be charged.

CAUTION: Make sure the product is packed in its original factory packaging including its foam and plastic wrapping material to prevent damage to the merchandise. There is no need to return the entire set if only one of the components is in need of repair unless otherwise instructed by the Service Center. The shipment must be prepaid and we recommend that it be insured. A cover letter including your name, address, daytime phone number, e-mail address (if available), Return Authorization number (if required by the service center, a copy of your sales receipt and a full description of the problem must be included to facilitate the repairs. Please include the description regardless of whether you discussed the problem with a service technician when contacting the Service Center for your Return Authorization.

Please make sure you have followed the instructions carefully before returning any merchandise for service. Authorized M.T.H. Service Centers are independently owned and operated and are not agents or representatives of M.T.H. Electric Trains. M.T.H. assumes no responsibility, financial or otherwise, for material left in their possession, or work done, by privately owned M.T.H. Authorized Service Centers.

If you need assistance at any time email MTH Service at service@mth-railking.com, or call 410 381-2580.

Limited One-Year Warranty

All M.T.H. products purchased from an M.T.H. Authorized Retailer are covered by this warranty provided the product was manufactured within five years of the date of purchase. This warranty is for the original purchaser and is non-transferable.

See our website www.mthtrains.com to identify an M.T.H. Authorized Retailer near you.

M.T.H. products may be registered online in advance of warranty work at www.mthtrains.com/warranty. The original sales receipt and the conditions below must be met regardless of whether the product is registered on the M.T.H. website in order to obtain warranty service.

M.T.H. products manufactured within five years from the date of purchase are warranted for one year against defects in material or workmanship, excluding wear items such as light bulbs, pick-up rollers, batteries, smoke unit wicks, and traction tires. We will repair, replace, or credit (at our option) the defective part without charge for the parts or labor if the following conditions are met: (1) the item is returned to an M.T.H. Authorized Service Center* (ASC) or M.T.H. National Authorized Service Center (NASC) or M.T.H. Electric Trains Service Department, (2) was manufactured within the previous five years and (3) was purchased within one year of the original date of purchase from an M.T.H. Authorized Retailer. Products manufactured after the five year cutoff from the date of purchase are not covered under any warranty by M.T.H. Electric Trains. The manufacture date of an item can be verified on the item's detail page "shipping date field" on the M.T.H. website (www.mthtrains.com). This warranty does not cover damages caused by improper care, handling, or use. Transportation costs incurred by the customer are not covered under this warranty.

Items sent for repair must be accompanied by a return authorization number, a description of the problem, and a **copy of the original sales receipt from an M.T.H. Authorized Retailer**, which gives the date of purchase. If you are sending this product to an Authorized Service Center, contact that Center for their return authorization.

This warranty gives you specific legal rights, and you may have other rights that vary from state to state. Specific questions regarding the warranty may be forwarded to M.T.H. Directly.

* Authorized Service Centers (ASC) are only obligated to provide warranty service for any consumer who has purchased the specific M.T.H. item from them that requires service work.

Service Department:
M.T.H. Electric Trains
7020 Columbia Gateway Drive
Columbia MD 21046-1532