

RAILKING
READY-TO-RUN™
THE COMPLETE SOLUTION

www.railking.com

F-3 Freight Set® Operation Manual



DCS
PROTO-SOUND
DIGITAL COMMAND SYSTEM

RAILKING
By MTH Electric Trains

Thank you for purchasing this RailKing product.
PLEASE READ BEFORE USE AND SAVE



Table of Contents

Set Up Checklist	3
Getting Started	4
Assembling RealTrax	4
Connecting the Transformer	4
Lubricating the Engine	5
Coupling the Engine and Cars	5
Checking the Battery	5
Remote Control	5
Basic Operation	6
Operation Buttons	6
Manual Volume Control	6
Proto-Sound 2.0 Operation	7
Activating Proto-Sound 2.0 Conventional Mode Features	7
Freight Yard Sounds (FYS)	7
Tips on Using FYS	8
Proto-Coupler® Operation	8
Speed Control	9
Lock into a Direction	9
Reset to Factory Defaults	10
Automatic Sounds	10
Maintenance	11
Care of Remote Control	11
Lubrication and Greasing Instructions	11
Cleaning the Wheels, Tires and Track	12
Locomotive Traction Tire Replacement	12
Locomotive Light Bulb Replacement	13
Caboose Light Bulb Replacement	13
Self-Charging Battery Back-Up	14
RailWare Interactive CDROM	15
Troubleshooting	16
Compatibility	18
Transformer Compatibility Chart	18
Additional Features with DCS Remote Control System	19
Exploded View Parts	20
Service and Warranty Information	24

CAUTION: ELECTRICALLY OPERATED PRODUCT:

Not recommended for children under 10 years of age. M.T.H. recommends adult supervision with children ages 10-16. As with all electric products, precautions should be observed during handling and use to reduce the risk of electric shock.

WARNING: When using electrical products, basic safety precautions should be observed, including the following: Read this manual thoroughly before using this device.

- M.T.H. recommends that all users and persons supervising use examine the hobby transformer and other electronic equipment periodically for conditions that may result in the risk of fire, electric shock, or injury to persons, such as damage to the primary cord, plug blades, housing, output jacks or other parts. In the event such conditions exist, the train set should not be used until properly repaired.
- Do not operate your layout unattended. Obstructed accessories or stalled trains may overheat, resulting in damage to your layout.
- This train set is intended for indoor use. Do not use if water is present. Serious injury or fatality may result.
- Do not operate the hobby transformer with damaged cord, plug, switches, buttons or case.
- The transformer was designed to operate on regular US household current (120 volt, 50-60 Hertz). Do not connect to any other source of power.
- To avoid the risk of electrical shock, do not disassemble the transformer unit. There are no user-serviceable parts inside. If the unit is damaged, contact M.T.H. Service for instructions.
- The transformer is equipped with an internal circuit protector. If the circuit protector trips, unplug the power cord from the electrical wall outlet, check your layout for any short circuits. The circuit breaker will reset automatically when the short is removed from the circuit.
- Unplug the transformer from the electrical wall outlet when not in use.
- Do not use this transformer for other than its intended purpose.

Transformer Ratings:

Input: 120VAC, 60Hz Only, Output: 21VAC, 3.75A/78VA

Set Up Checklist

- Assemble RealTrax®
- Connect the transformer
- Lubricate the engine
- Place the engine and car on the track and couple them together
- Position remote lock-on lens
- Check to see whether the battery needs to be charged for full sound effects
- Apply power to run as described in the Basic Operation section of these instructions.

Set Includes



Steam Engine with Proto-Sound 2.0

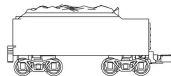

Steam Tender



8-Pieces
O-31 Curve RealTrax

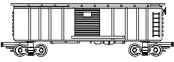

Box Car



Lock-On

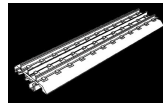

4-Pieces
Straight RealTrax

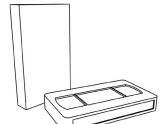

Video

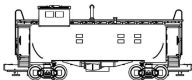

Caboose



Remote Control or

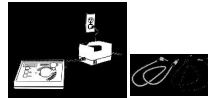

Controller with wire harness

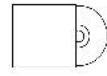

CD-Rom

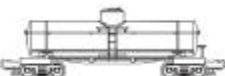

Tank Car

Tools Needed



Battery Charger (Optional)



Pliers



Scissors

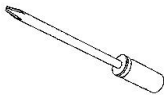

Phillips Screwdriver



Cotton Swab or Rag



RailKing Maintenance Kit or
Light Household Oil and Bearing Grease

You can obtain replacement parts and replacement instructions from the M.T.H. Parts Department

e-mail: parts@mth-railking.com

phone: 410-381-2580

mail: 7020 Columbia Gateway Drive, Columbia MD 21046-1532

Getting Started

Assembling RealTrax®

The quick connectors and built-in road bed allow you to setup RealTrax anywhere, including carpeted surfaces.

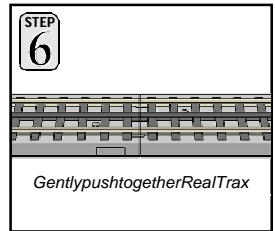
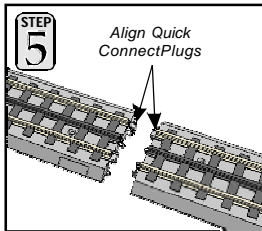
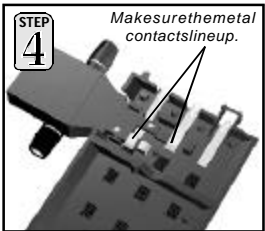
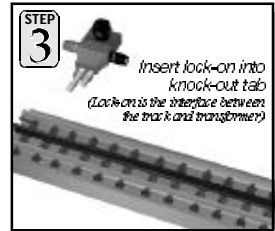
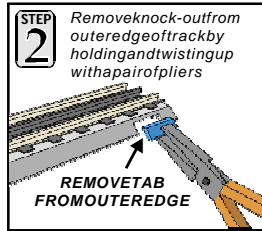
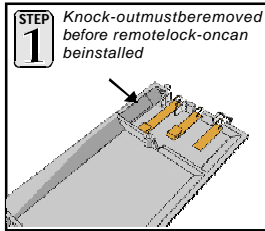

Connecting Track Clips

If you prefer not to screw your track to the table for a permanent layout, use the enclosed track clips on adjoining curved RealTrax sections to secure them in place.

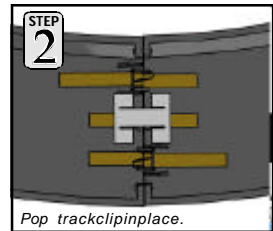
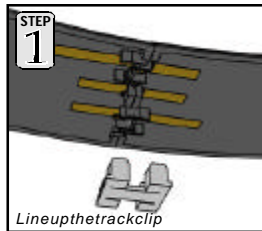

Connecting the Transformer

The 75-watt power supply included with this set provides an easy-to-use, safe power source for AC-powered trains and accessories.

- Plug the wire from the transformer into the remote lock-on's center port, then plug the transformer into the wall outlet.
- Unplug when not in use.

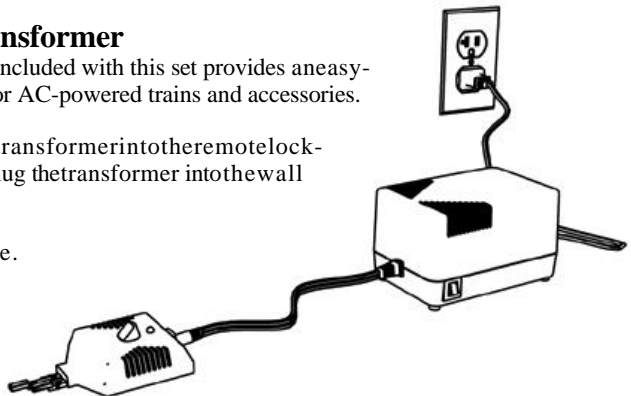

Lubricating and Greasing the Engine

Lubricate all exposed moving parts before operating using a multi-purpose, plastic-compatible oil (available with M.T.H.'s Maintenance Kit, sold separately) or a light household oil. Follow the lubrication points.

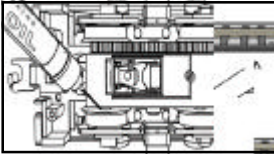

Lubricate Axles

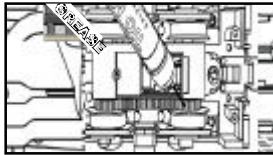

Grease Gears

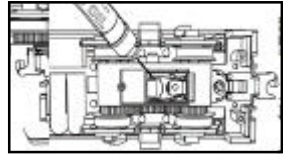

Lubricate Pick-Up Rollers
(Do Not Lubricate the Flat Part of Pick-Up Rollers)

Coupling the Engine and Car

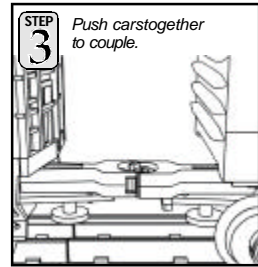
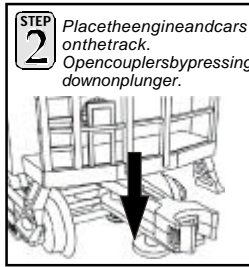
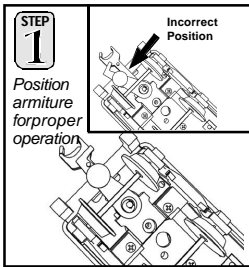

Checking the Battery

You may find, if your set was built several months before you set it up, that the rechargeable battery has run down and needs to be charged before operating. If you notice that the sounds are garbled, test and charge the engine as described in "Self-Charging Battery Back-Up" on page 14.

Remote Control

The remote and lock-on are redesigned for use with moderate power supplies such as the one included with this set. It is compatible with virtually any manufacturer's engines.

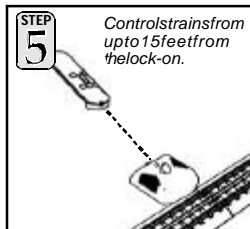
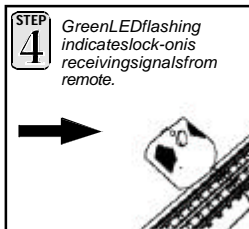
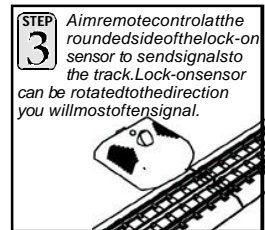
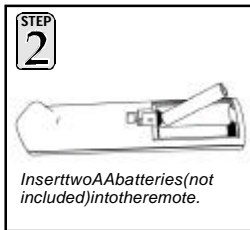
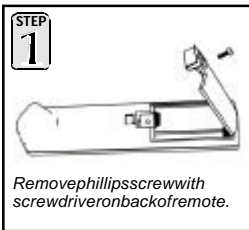

Note: The RailKing® Remote Control and Remote Lock-on will not operate engines equipped with pre-1997 versions of Proto-Sound® or with Proto-One,™ Proto-Plus,™ Proto-Deluxe,™ aftermarket systems.

Basic Operation

Operation Buttons

Throttle Up Throttle up the power to your track by pressing the top end of the Throttle Control Rocker Switch firmly for about 5 seconds, until the engine's headlight and lighted cars burn bright. Then put the engine in motion by firmly pressing the Direction button (hold it for approximately 1 second) on your remote once. If the engine does not begin to move as soon as you firmly press the Direction button, you may not have sent enough voltage to the track to make the train move. Press the throttle up for a few more seconds until the train begins to move. To increase or decrease track voltage, and therefore train speed, press the throttle control rocker switch. Pressing the top end of the throttle will increase voltage and speed. Pressing the bottom end of the throttle will decrease voltage and speed. The engine will maintain the speed you set after you release the throttle until you press it again to change the voltage and speed.

Bell - To sound the bell, firmly press and release the Bell button. To turn the bell off, press and release the Bell button again. The bell will continue to ring from the time you turn it on until you press and release the button again to turn it off.

Emergency Stop Press the Emergency Stop button and all trains on the track controlled by the remote will stop until you reapply voltage. This is an easy way to shut down your trains at the end of a session or to stop suddenly if the train's path becomes obstructed.

CAUTION: Do not mix old and new batteries. Do not mix alkaline, standard (carbon-zinc), or rechargeable (nickel-cadmium) batteries.

Manual Volume Control

To adjust the volume of all sounds made by this engine, turn the master volume control knob located under the engine clockwise to increase the volume and counter-clockwise to decrease the volume.

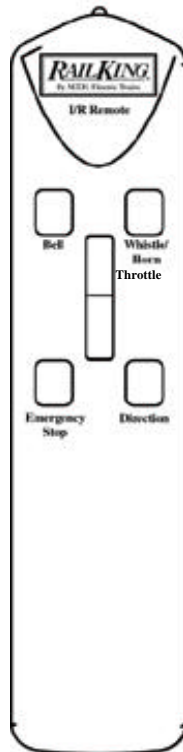

Horn/Whistle - To sound the horn, firmly press the Horn/Whistle button. The horn will sound for as long as you continue to depress the button. It will stop when you release the button.

Direction Your train is programmed to start in neutral. The train will always cycle neutral-forward-neutral-reverse with each press and release of the direction button. The engine is programmed to restart in neutral each time the track voltage is turned off for 25 seconds or more.

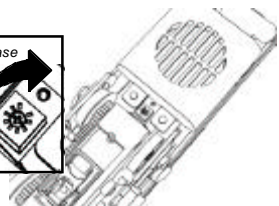
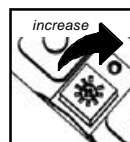
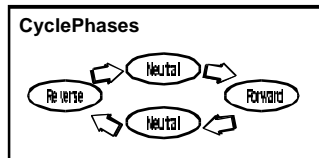

Proto-Sound 2.0 Operating Instructions

This manual contains the operating instructions for Proto-Sound 2.0 in conventional mode only. Instructions for accessing DCS command mode features accompany the DCS Remote Control System equipment.

Activating Proto-Sound 2.0 Conventional Mode Features:

Proto-Sound 2.0 features are activated by sequences of Bell and Horn button pushes described below. Please read the full descriptions of each feature before using it. To use these buttons to activate features rather than to blow the horn or ring the bell, you should tap the buttons very quickly with a 1/2-second pause between button presses. You may need to practice your timing to make this work smoothly.

Timing Chart				
Press Horn Short & Firm	1/2 Sec. Pause	Press Bell Short & Firm	1/2 Sec. Pause	Press Bell Short & Firm
Total Time Lapse: 1 1/2 Seconds				

Feature to Be Activated	Button Code:
Freight Yard Sounds	1 Bell, 2 Horns
Fire the Rear Coupler	1 Bell, 3 Horns
Fire the Front Coupler	1 Bell, 4 Horns
Speed Control On/Off	1 Horn, 2 Bells (from Neutral only)
Lock into a Direction	1 Horn, 3 Bells
Reset to Factory Defaults	1 Horn, 5 Bells (from Neutral only)

Freight Yard Sounds (FYS):

Your engine is equipped with a sound package of freight yard sounds that you can play when you pull into a yard. **Each sequence described below will play as long as it is left on, randomly generating sounds, but be sure to allow approximately 30 seconds between the button pushes described below to allow the FYS sufficient time to run through each sequence.**

- To cue the sound system to play the FYS, quickly but firmly tap the Bell button once followed by 2 quick taps of the Horn button while the engine is moving. Tap the buttons quickly but allow approximately 1/2 second between each press.
- Press the Direction button once to stop the engine. This will trigger the first sequence of FYS. Thereverse unit is temporarily disabled so that the train will not move as you use the Direction button to trigger the sounds, and Proto-Sound 2.0 has disabled operator control over the Horn and Bell buttons until the full FYS sequence is complete.
- After waiting about 30 seconds for that sequence to run, press the Direction button again to trigger the second sequence of FYS.
- After about 30 seconds, press the Direction button again to trigger the third FYS sequence.

- Again, after allowing about 30 seconds for that sequence to run, press the Direction button one more time to trigger the fourth and final FYS sequence. The FYS will continue, and within a few seconds, the engine will start and move out on its own at the current throttle setting, in the same direction it was traveling when you began the sequence. Once the bell turns off, the operator regains control of the transformer's Bell and Horn buttons and can ring the bell or blow the horn as usual.

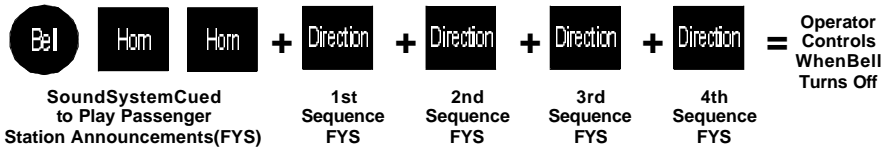

Tips on Using FYS

- You can terminate FYS at any time by turning off power to the track for 15 seconds.
- You do not have to be in Forward to use FYS. At the conclusion of the full sequence, the train will pull away from the station in whatever direction you were going when you activated the feature.
- You can use FYS even if you are double-heading with another engine. If the second engine is not equipped with Proto-Sound 2.0, you must remember not to leave the throttle at a high voltage level once you have stopped the engine to run the FYS. Otherwise, the engine without FYS will begin vibrating on the track as its motors strain to move the train, since they cannot be automatically disabled during the FYS cycle (or if an original Proto-Sound engine, FYS are triggered differently and that engine's motor-disable feature will not be active when you run FYS in Proto-Sound 2.0).
- FYS can be triggered from Neutral. It will operate the same as if triggered while in motion except that, at the conclusion of the FYS, the engine will depart in the next direction of travel, as opposed to the direction it was traveling before entering Neutral.

Proto-Coupler® Operation

This locomotive is equipped with one or more coil-wound Proto-Couplers for remote uncoupling action. Because Proto-Couplers are controlled through the Proto-Sound 2.0 microprocessor, they do not require an uncoupling track section or modification to your layout to function. You can fire a coupler from neutral or while in motion. Use the code shown below (and in the chart on p. 7) to fire the coupler(s).

Rear Coupler:

To fire the rear coupler, quickly tap the Bell button once followed by three quick taps of the Horn button, allowing approximately 1/2 second to lapse between each quick button press. The sound of the lift bar and air line depletion will play, and the knuckle will be released.



Front Coupler:

To fire the front coupler (if your engine has one), quickly tap the Bell button once followed by four quick taps of the Horn button, allowing approximately ½ second to lapse between each quick button press. The sound of the lift bar and air line depletion will play, and the knuckle will be released.



Speed Control:

M.T.H. engines equipped with Proto-Sound 2.0 have speed control capabilities that allow the engine to maintain a constant speed up and down grades and around curves, much like an automobile cruise control. You can add or drop cars on the run, and the engine will maintain the speed you set.

While the engine is programmed to start with the speed control feature activated, you can opt to turn it off. This means the engine's speed will fall as it labors up a hill and increase as it travels downward. It is also affected by the addition or releasing of cars while on the run. Because the engine will run more slowly at a given throttle voltage when speed control is on than when it is off, you should adjust the throttle to a lower power level for operation with speed control off to avoid high-speed derailments. When speed control is off, the volume will drop to allow for better low voltage operation.

To turn speed control on and off, put the engine in neutral, then quickly tap the transformer's Horn button one time then quickly tap the Bell button two times, allowing approximately ½ second to lapse between each quick button press. Two horn blasts will indicate that the engine has made the change. Repeat the 1 horn, 2 bells code to return it to the other condition. You will want to do this during the initial neutral upon start-up if you ever couple this engine to another engine that is not equipped with speed control to avoid damaging the motors in either engine. Each time you shut down the engine completely, it will automatically turn speed control on.



Lock into a Direction:

You can lock your engine into a direction (forward, neutral, or reverse) so that it will not change directions. To do this, put the engine into the direction you want (or into neutral to lock it into neutral), run it at a very slow crawl (as slowly as it will move without halting), and quickly but firmly tap the Horn button once followed by three quick taps of the Bell button, allowing approximately ½ second to lapse between each quick button press. Two horn blasts will indicate that the engine has made the change. The engine will not change direction (including going into neutral) until you repeat the 1 horn, 3 bells code to return the engine to its normal condition, even if the engine is kept without power for extended periods of time.



Reset to Factory Defaults:

To override the settings you currently have assigned to the engine and reset it to its factory defaults, while in Neutral tap the Horn button quickly once, followed by five quick taps of the Bell button, allowing approximately ½ second to lapse between each quick button press. Two horn blasts will indicate that the engine has made the change.



Automatic Sounds:

Certain Proto-Sound 2.0 sound effects automatically play in programmed conventional mode conditions:

- **Squealing Brakes** play any time the engine's speed decreases rapidly.
- **Cab Chatter** plays at random intervals when the engine idles in neutral.
- **Engine Start-up and Shut-down** sounds play when the engine is initially powered on or powered off for five seconds or more.

Maintenance

Care of the Remote Control

Your RailKing Remote Control System should offer years of trouble-free service. There are a few things you can do to ensure trouble-free operation:

- If your train responds inconsistently, replace old batteries with fresh ones. Do not mix old and new batteries.
- Remove batteries before storing for extended periods.
- Do not drop the remote. It can damage the delicate electronics inside.
- Any attempt by anyone other than an authorized M.T.H. repair person to open and repair the handheld transmitter or lock-on may result in damage and the loss of warranty protection.

Lubricating and Greasing Instructions

The engine should be oiled and greased in order to run properly.

Regularly lubricate all axles and linkage components and pickup rollers to prevent squeaking. Use light household oil, such as that found in M.T.H.'s maintenance kit. Do not overoil. Use only a drop or two on each pivot point.

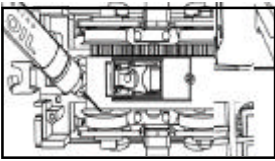

Lubricate Axles

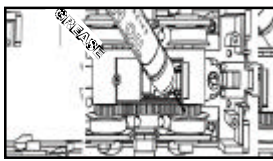

Grease Gears

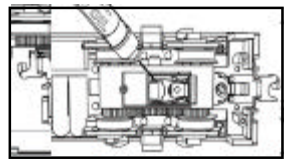

Lubricate Pick-Up Rollers
(Do Not Lubricate the Flat Part of Pick-Up Rollers)

The locomotive's internal gearing was greased at the factory. Grease engine every 50 hours of use or one year. Use a lithium based grease and follow the greasing instructions.

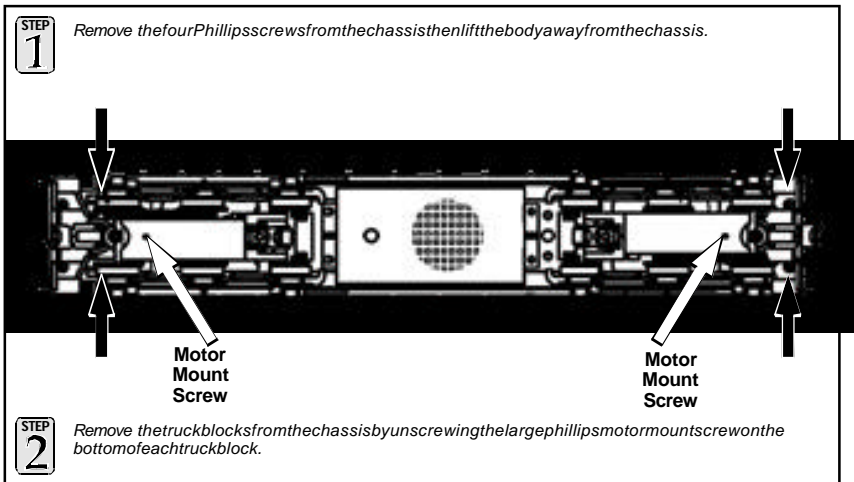

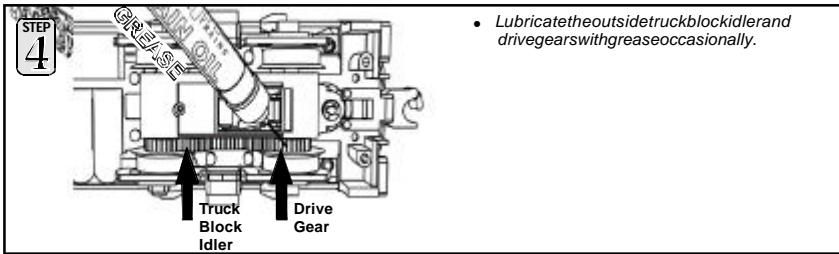
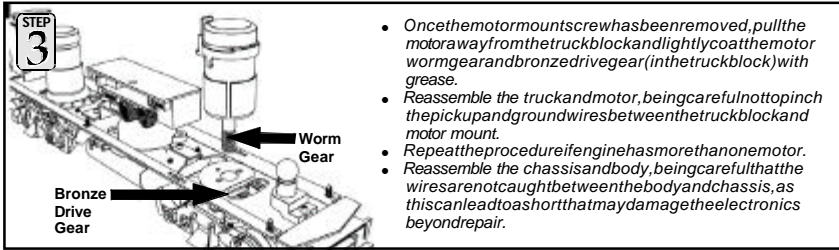

Cleaning the Wheels, Tires and Track

Periodically check the locomotive wheels and pickups for dirt and buildup, which can cause poor electrical contact and traction and prematurely wear out the neoprene traction tires. Wheels and tires can be cleaned using denatured (not rubbing) alcohol applied with a cotton swab.



To clean the track, use RailKing Track Cleaning Fluid and a clean rag or denatured (not rubbing) alcohol. Unplug the transformer and wipe the rails of the track, turning the rag frequently to ensure that you are using clean cloth on the rails. Because the manufacturing process leaves a coating on RealTrax center rail, you should clean the rails after the first 30 minutes of use (you may notice an electrical smell during initial use as the coating wears off; this is normal). Thereafter, keep an eye on the track and clean it when it gets dirty to ensure good electrical contact and to lengthen the life of the tires.

Traction Tire Replacement Instructions

Your locomotive is equipped with two neoprene rubber traction tires on the rear set of flanged drivers. While these tires are extremely durable, you may need to replace them at some point.

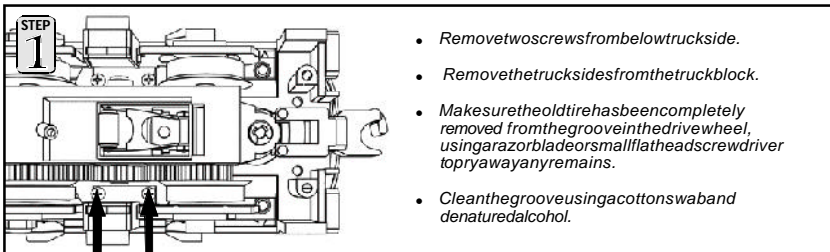

STEP 2

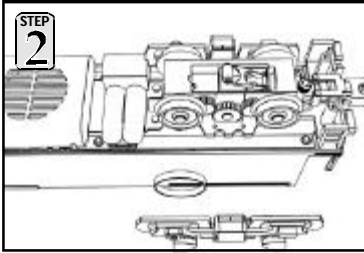

- Slip the new tire onto the wheel. You may find it useful to use two small flathead screwdrivers to stretch the tire over the wheel.
- If you twist the tire while stretching it over the wheel, you will need to remove and reinstall the tire. Otherwise your engine will wobble while operating.
- Make sure the tire is fully seated inside the groove. Use a razor blade to trim away any excess tire that doesn't seat itself inside the groove properly.
- Reassemble the truck sides to the truck blocks.

Locomotive Light Bulb Replacement

Follow the cab removal instructions found in the Greasing Instructions section of this booklet (page 11).

- Rotate the headlight bulb counter-clockwise to remove.

You can obtain replacement bulbs directly from the M.T.H. Parts Department.

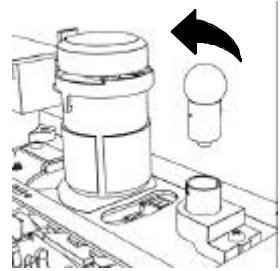

Replacement Caboose Light Bulb Replacement

To replace the interior light bulbs follow these instructions and see the diagrams below.

STEP 1

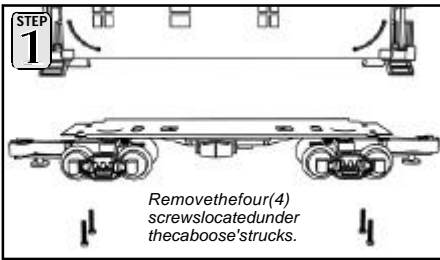

Remove the four (4) screws located under the caboose trucks.

STEP 2

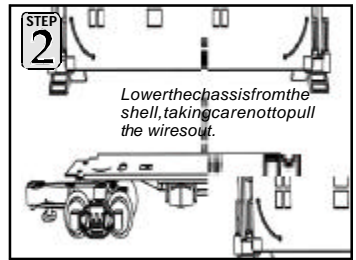

Lower the chassis from the shell, taking care not to pull the wires out.

STEP 3

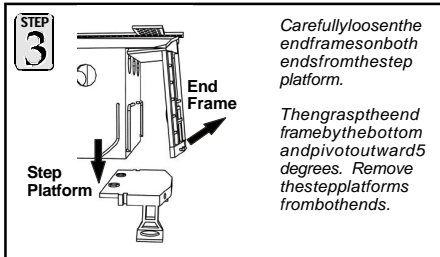

Carefully loosen the end frames on both ends from the step platform.

Then grasp the end frame by the bottom and pivot outward 5 degrees. Remove the step platforms from both ends.

STEP 4



Lower the chassis from the shell, taking care not to pull the wires out.

STEP 5



Replace the bulb by pushing it in at an angle from the bulb holder. Push the bulb from its socket.

Replace with a new bulb and reassemble the caboose.

Light Bulb
#CG-0000017)

Self-Charging Battery Back-Up

This special NiCad 7-cell 8.4v self-charging battery recharges continuously during train operation and should last for up to five years. The battery is a dry battery that should not leak or cause any damage to your engine. **Depending upon when your engine was built, it may need to be charged right out of the box.** If engine sounds seem distorted or garbled at low voltages or become silent when power from the transformer is turned off, test the battery to determine whether it should be recharged or replaced.

- **Test:** Put the engine in neutral and leave the track voltage at 10-12 volts (high enough for the lights to shine brightly and the engine to move steadily) for 15 minutes.
- **Recharge:** If the sounds are improved at the end of the 15-minute test charge, the battery charge has run down and can be recharged. There are a number of ways you can do this:
 - Leave the engine in neutral with track voltage at 10-12 volts for 6-7 hours so the battery can fully recharge (if your engine has a smoke unit, be sure it is turned off).
 - Use M.T.H.'s battery recharger (sold separately) that plugs into a wall outlet and a special port under the engine to recharge the battery overnight without leaving it on the track.

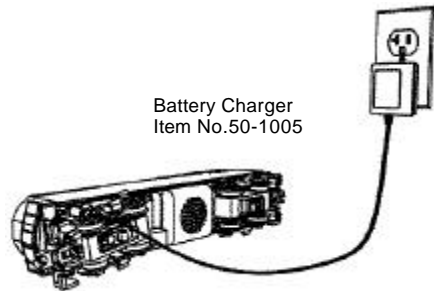

- **Replace:** If the sounds are not improved at the end of the 15-minute test charge, it is time to replace the battery. Available through M.T.H. Parts. A standard 9v alkaline battery can be substituted until your replacement arrives, but since alkaline batteries cannot be recharged, it will eventually wear down. **Do NOT use a 6-cell 7.2v battery.**

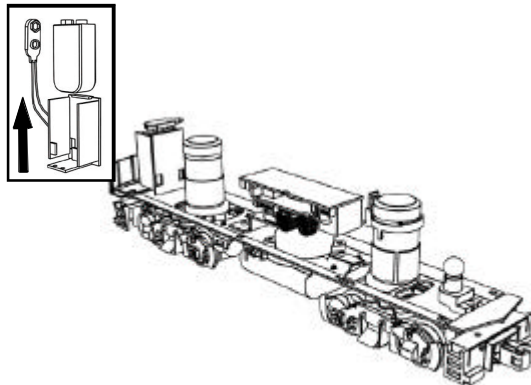

Quick-Start Video

The included VHS Quick-Start video demonstrates the start-up and basic operation of this set as well as other information about model railroading. You may find it helpful to view the video before operating this set.

RailWare Interactive CD ROM

M.T.H. provides a free RailWare CD ROM in each Ready-To-Run set. It is full of helpful information on M.T.H. product history, track planning software, a dealer finder, and information and video clips on Loco-Sound and Proto-Sound 2.0. Follow the directions below to use the CD ROM.

Minimum System Requirements: Pentium 100, 16MB RAM, Windows 95 or later, CD ROM drive, Sound Card, display properties set to greater than 256 colors. The CD will not work on a Mac OS unless you run VirtualPC®.

Running RR-Track Software

You may run the RR-Track software directly off of the CD ROM or you may install the software to your hard drive.

1. On the Desktop, click on the icon that says My Computer.
2. Find your CD ROM drive.
3. With the M.T.H. CD ROM in the drive, double click on the icon for the CD ROM drive.
4. Find the folder on the CD ROM entitled INSTALLATION.
5. Choose the folder inside entitled RRTRAXSETUP.
6. Run the file in that folder called SETUP.EXE and follow the directions it provides.

The program may ask you for a registration code. If it does type in "M.T.H." and it will run.

Additional track libraries can be obtained directly from RR-Track. See their website for more information www.rtrack.com.

Installing Adobe Acrobat Software

To read some of the electronic documents included on the CD ROM, you will need to install the Adobe Acrobat Reader® if it is not already on your computer. To install the software:

1. On the Desktop, click on the icon that says My Computer.
2. Find your CD ROM drive.
3. With the M.T.H. CD ROM in the drive, double click on the icon for the CD ROM drive.
4. Find the folder on the CD ROM entitled INSTALLATION.
5. Choose the folder inside entitled ACROBAT READER.

*If you are running Windows 95, 98 or NT choose the folder 32BIT. Run the file AR32E301.EXE and follow the directions it provides.

If you have problems you cannot resolve by using these directions, contact custserv@mth-railking.com or call 410-381-2580 for further help.

Troubleshooting Proto-Sound® 2.0 Problems

Although Proto-Sound 2.0 has been designed and engineered for ease of use, you may have some questions during initial operation. The following table should answer most questions. If your problem cannot be resolved with this table, contact M.T.H. for assistance (e-mail: service@mth-railking.com; telephone: 410-381-2580; fax: 410-423-0009; mail: 7020 Columbia Gateway Drive, Columbia MD 21046-1532).

Starting Up	Remedy
When I first turn the power on, the engine will not begin to run.	This is normal behavior. To prevent accidental high-speed start-ups, Proto-Sound 2.0 is programmed to start up in neutral any time track power has been turned off for several seconds. See the "Basic Operation" section for more details.
The engine will not start after I press the Direction button.	You may not be sending enough power to the track to power the engine. Press the throttle up for a few more seconds to increase track power.
My engine sounds are distorted and garbled.	The battery may have run down, especially if the engine has been in storage for some time. See the "Self-Charging Battery Back-Up" section of these instructions for how to test, recharge, and (if necessary) replace the battery.
Horn	Remedy
I can't get the horn to blow when I press the Horn button.	You may be pressing the button too quickly. Try pressing the Horn button more slowly, taking approximately one full second to fully depress the button.
Bell	Remedy
I can't get the bell to ring when I press the bell button.	You may be pressing the button too quickly. Try pressing the bell button more slowly, taking approximately one full second to fully depress the button.
Coupler	Remedy
When I try to fire the coupler, FYS starts.	You are waiting too long between Horn button presses. See the timing instructions located at the beginning of the "Proto-Sound 2.0 Operating Instructions" section.
The Proto-Coupler won't let the engine uncouple on the fly.	Try lubricating the coupler knuckle and drivet with a dry graphite lubricant.
The coupler does not fire or stay coupled.	The coupler needs to be cleaned. Wipe with denatured alcohol (not rubbing alcohol) and let dry.
Cab Chatter	Remedy
Sometimes the Cab Chatter sounds don't play.	Cab Chatter plays only in neutral at random intervals.
Lock-out	Remedy
I can't get the engine to run after I power up the transformer. It's still with the diesel and compressors sounds running. The engine won't lock into forward, neutral, or reverse.	The engine may be locked into the neutral position. Follow the procedure in the "Lock into a Direction" section to unlock the engine's direction. Engine speed must be below 10 scale mph (approx. 10 volts or less in conventional mode).

Volume	Remedy
The sounds seem distorted, especially when the Horn or bell is activated.	Proto-Sound 2.0 volume is set too high. Turn the volume control knob on the bottom of the chassis counter-clockwise to reduce the volume.
No Sound	Volume is set too low, adjust volume control knob on the bottom of the chassis clockwise to increase the volume or check connector to speaker.
Battery	Remedy
The engine will not leave the initial neutral setting.	Check to be sure the battery is installed and fully charged. See the "Self-Charging Battery Back-Up" section.
I get no sounds when the engine shifts between directions.	The battery may be dead or need to be charged. See the "Self-Charging Battery Back-Up" section.
After I turn off my transformer, my engine continues to make sounds before quitting.	Proto-Sound 2.0 is designed to continue to sound for a few seconds after power to the track has been shut off to allow for a more realistic shut-down.
FYS	Remedy
The FYS sounds occasionally repeat themselves.	Proto-Sound 2.0 has a built-in random number generator that randomly selects each sound clip to play. Because there are a limited number of sound clips available in each FYS sequence, it is probable that some of these sound clips will be repeated from time to time.
Once in FYS, the engine doesn't go into reverse.	So that FYS effects can be as realistic as possible, Proto-Sound 2.0 disables the reversing unit whenever FYS is enabled. This way the engineer remains still at its stop as the operator cycles through the FYS sequences.
When the FYS enters its last sequence the bell automatically comes on.	FYS is programmed to start ringing the bell and then to put the engine in motion at that point. After approximately 15 rings of the bell, it will automatically turn off.
When FYS is enabled, pressing the Horn and bell button has no effect.	Because FYS must control various effects in each sequence, Proto-Sound 2.0 takes control of these sound effects until you exit FYS.
I push the Direction button but the next sound clip in the sequence does not play or the engine does not come out of FYS after the fourth press of the Direction button.	Each FYS clip must play for a certain amount of time before FYS will advance to the next step in the FYS cycle. Wait at least 30 seconds in each FYS sound clip before pressing the Direction button.

Compatibility

While this Ready-To-Run set is equipped with everything you need to operate it, the design allows flexibility. The train will operate on any traditional O-31 or larger O Gauge track system, including the RealTrax® included with this set or traditional tubular track. It is also compatible with most standard AC transformers, including the hobby transformer packaged with your set.

Transformer Compatibility and Wiring Chart

Note that many of the operational commands described in these instructions require a bell button, so if you are using a transformer other than the one included in this set and your transformer does not have its own bell button, you should consider adding one to get the full benefit of the system.

Transformer Model	Center Rail	Outside Rail	Min/Max. Voltage	Power Rating	Transformer Type
MTHZ-500	Red Terminal	Black Terminal	0-18v	50-Watt	Electronic
MTHZ-750	Red Terminal	Black Terminal	0-21v	75-Watt	Electronic
MTH Z-4000	Red Terminal	Black Terminal	0-22v	390-Watt	Electronic
Lionel1032	U	A	5-16v	90-Watt	Standard
Lionel1032M	U	A	5-16v	90-Watt	Standard
Lionel1033	U	A	5-16v	90-Watt	Standard
Lionel1043	U	A	5-16v	90-Watt	Standard
Lionel1043M	U	A	5-16v	90-Watt	Standard
Lionel1044	U	A	5-16v	90-Watt	Standard
Lionel1053	U	A	8-17v	60-Watt	Standard
Lionel1063	U	A	8-17v	60-Watt	Standard
All-Trol	Left Terminal	Right Terminal	0-24v	300-Watt	Electronic
Dallee Hostler	Left Terminal	Right Terminal			Electronic
Lionel LW	A	U	8-18v	75-Watt	Standard
Lionel KW	A or B	U	6-20v	190-Watt	Standard
Lionel MW	Outside Track Terminal	Inside Track Terminal	5-16v	50V.A.	Electronic
Lionel RS-1	Red Terminal	Black Terminal	0-18v	50V.A.	Electronic
Lionel RW	U	A	9-19v	110-Watt	Standard
Lionel SW	U	A	Unknown	130-Watt	Standard
Lionel TW	U	A	8-18v	175-Watt	Standard
Lionel ZW	A, B, C or D	U	8-20v	275-Watt	Standard
Lionel Post-War Celebration Series ZW	A, B, C or D	Common	0-20v	135/190 Watt	Electronic

Additional Features Accessible with the DCS Remote Control System: (additional equipment required)

While conventional mode operation of a Proto-Sound 2.0 engine yields wonderfully realistic sound and several train control features, command mode operation allows the user to access a world of command functions never before accessible to O Gauge railroaders. With the addition of the DCS Remote Control System (including a DCS remote handheld and Track Interface Unit) users gain many advanced features, including:

- DCS Proto-Speed Control - Establishes desired locomotive speed in scale miles per hour increments via a thumb wheel control and allows operator to set maximum speed and acceleration/deceleration rates
- ProtoSmoke[®] Variable Output Control - Controls how much smoke each engine outputs and matches smoke to locomotive speed
- Locomotive Lighting Control - Controls locomotive headlights, marker and interior lights, beacon lights, ditch lights, and MARS lights
- Emergency Stop-Single button push stops all Proto-Sound 2.0 trains but does not turn off the power
- One Touch Global Mute/UnMute-Single button mutes or unmutes all DCS-controlled locomotives' user-defined actions, including sound, lights, and smoke
- Proto-Dispatch Operation-Public Address-like feature allows user to speak through locomotive speaker during operation
- Proto-Cast-Allows users to play audio recordings through locomotive speaker during operation
- Proto-Doppler Sound Effects Set Up-Users can configure locomotive for Doppler Operation, including setting distance points for Doppler start, repeat, and stop modes
- Independent Volume Control of Engine Sounds, Bell, Horn & Whistle for each Locomotive
- Control up to 50 different DCS-Equipped Locomotives at one time with multiple TIUs
- Proto-Effects[™] Set Up-User can select individual Proto-Effects[™] operations to be active or inactive, including cab chatter, train wreck sounds, coupler sounds, and wheel clickety-clack sounds
- Direction Control Set Up-User can set initial individual start-up direction (start in forward or reverse) for double-heading operations
- Locomotive Consist Set-up-User can determine locomotive values for consist make-ups, allowing multiple locomotives belonging to a consist to operate together
- Query Locomotive Information-User can query locomotive programming to learn locomotive address and engine data information, including scale miles traveled
- User Can Query, Set and Operate Track and Accessory Interface Units for Programming Digital Command Operations for up to 250 Accessories and 250 Individual Switches
- User Can Script, Record and Playback Train Routes

Operating instructions for all DCS Command features will accompany the DCS remote control equipment.

F-3 Diesel Locomotive Engine Parts

~~Engine Parts~~

Name and Number		Part #	\$Price Per Unit
1.)	Diaphragm (black)(3 rib) (26.0x50.0x10.0mm)(2 center mount tabs)	FI-0000027	2.00
2.)	Shell (black, yellow, green) (John Deere)	FC-2200375	*65.00
3.)	Lens (clear) (portal)(9.3x8.3x1.7mm)	FA-2260001	2.00
4.)	Horn (nickel)(1 chime)	FC-2200010	3.00
5.)	Battery charger jack (complete)	BG-0000001	3.00
6.)	Number board (#4010) (white numbers on black background)(sticker) (John Deere)(#4010)	FG-2200104	0.25
7.)	Lens (clear) (headlight)(7.7x6.7x4.5mm)	FA-2230009	2.00
8.)	Windows (clear)(front & sides)	FA-2230008	5.00
9.)	Rubber band	BI-4500004	0.50
10.)	Tach board (standard)(for Proto-Sound 2.0® and Loco-Sound™)	AG-0000033	6.00
11.)	Motor (RS-365SH) (7.8x17.0mm worm gear w/ 10.5mm long threads) (9.0x30.0mm white tapered flywheel w/ black stripes) (w/ tach board mount)	BE-0000142	25.00
12.)	Boards (Proto-Sound® 2.0) (Proto-Sound® 2.0)(w/ Rom memory)(5v board)	AE-0000001	*200.00
13.)	Motor (RS-365SH) (7.8x17.0mm worm gear w/ 10.5mm long threads) (9.0x30.0mm black tapered flywheel)	BE-0000143	25.00
14.)	Bulb (6v)(small globe) (bayonet base)(headlight/cab interior)	CG-0000024	1.00
15.)	Socket (black)(plastic)(7.0mm thick bayonet base)	CH-0000037	3.00
16.)	Screw (M3x6.0mm)(roundhead)	IA-0000016	0.15
17.)	Motor mount (black)	BI-0000005	15.00
18.)	Screw (4/40x6.0mm)(roundhead)	IA-0000003	0.15
19.)	Screw (6/32x12.0mm)(roundhead)	IA-0000062	0.15
20.)	Screw (M3x4.0mm)(roundhead)	IA-0000010	0.15
21.)	Screw (yellow Zinc) (M2.5x6.0mm)(roundhead)(w/ lock washer)	IA-0000089	0.15
22.)	Screw	IA-0000012	0.15

23.)	(M3x14.0mm)(roundhead)(w/ lock washer) Screw	IA-0000035	0.15
24.)	(M3x8.0mm)(roundhead) Bracket (Aluminum) (for Proto-Sound® 2.0 boards) (mounts boards sideways)	IH-0000385	4.00
25.)	Wire strap (black)(metal)(small)	IH-0000012	1.00
26.)	Insulator (white) (washer)(3.0x6.0x3.0mm)(plastic)	ID-0000025	0.15
27.)	Voltage regulator (LM2937ET)	AG-0000032	3.00
28.)	Volume pot (small) (blue pot mounted on green PC board)	BI-0000040	5.00
29.)	Spacer (black) (3.0x6.0x4.0mm)(plastic)	ID-0000071	0.15
30.)	Insulator (clear) (13.0x16.0x0.1mm)(single hole)	ID-0000024	0.15
31.)	Switch (large)(2 position)	BB-0000006	5.00
32.)	Screw (M2x4.0mm)(roundhead)	IA-0000058	0.15
33.)	Bracket (brass)(speaker) (6.0x8.5x1.0mm)(rounded corners on one end)	IH-0000372	1.00
34.)	Wire nut (yellow)	BI-4500003	0.25
35.)	Battery leads (60.0mm long wires w/ small black male 2 pin plug) (80.0mm long wires w/ battery charger jack)	BC-0000189	6.00
36.)	Battery (8.4 volts)(re-chargable)(nickel-cadium)	BG-4000001	10.00
37.)	Bracket (black)(metal) (9.3x46.0x34.4mm)(horizontal mount)(battery)	IH-0000165	3.00
38.)	Screw (4/40x6.0mm)(flathead)	IA-0000038	0.15
39.)	Pilot (black)(front) (2 screw holes for mounting pilot)	DG-2230026	15.00
40.)	Chassis (black)(A unit) (Proto-Sound® 2.0 & Loco-Sound™) (w/ holes for battery charger jack)	DH-2200079	*20.00
41.)	Speaker (Star)(NR-045-A1Z04)(16 ohms)(2.0 watt)	BF-0000031	10.00
42.)	Screw (M3x16.0mm)(washer head)(self-drilling)	IA-0000025	0.15
43.)	T-bar (black) (4.0x20.0mm)(plastic)	IG-0000001	0.50
44.)	Proto-Coupler® (Proto-Coupler® 2.0)(44.5mm long)	DD-0000033	10.00
45.)	Spring (nickel) (6.5x14.0mm)(0.5mm thick wire)	IE-0000022	0.50
46.)	Washer (4.5x10.0x0.6mm)	ID-0000041	0.15
47.)	E-clip (3.0x8.0x0.5mm)	IF-0000002	0.15

48.) Truck (black)(2 axle) (powered)(2 holes tapped for mounting pilot) (2 M2.5 holes tapped for mounting PCB under coupler) (truck sides mount from bottom)	DA-2000030	*30.00
49.) Insulator (black) (pick-up)(plastic)(top)(square)	BD-0000047	2.00
50.) Traction tire (black) (rubber)(4.0x17.0mm)	DE-0000018	0.75
51.) Nut (nickel)(2.5x5.0x10.0mm)	IC-0000005	0.50
52.) Insulator (black) (pick-up)(plastic)(bottom)(square)	BD-0000039	2.00
53.) Pick-up (8.0x11.0mm roller)(28.0mm long)	BD-0000025	5.00
54.) Truck side (black) (fits 2 axle truck)(truck side screws mount from bottom)	DB-2150002	7.00
55.) Screw (M2x4.0mm)(roundhead)	IA-0000058	0.15
56.) Wire harness (black flat male 4 pin plug w/ 130.0mm long wires) (w/ black female 4 pin plug on PC board)	BC-0000190	10.00
57.) Spacer (black)(hexagon shaped) (25.0mm long)(4.0mm long M2.5 screw on one end) (M2 tapped hole on the other end)	ID-0000121	1.00
58.) Truck (black)(powered) (2 axle)(2 holes tapped for mounting pilot) (truck sides mount from bottom)	DA-2000012	*30.00
59.) Screw (nickel) (M3x6.0mm)(roundhead)	IA-0000015	0.15
60.) Gasket (black)(foam) (39.0x45.0x2.0mm)(for 45.0mm speakers)	IB-0000013	1.00
61.) Screw (M3x3.0mm)(roundhead)	IA-0000296	0.15
NS.) Speaker cone (cardboard)	BF-0000032	2.00
NS.) Bracket (black)(metal) (8.0x62.5mm)(18.5mm step)(2 mounting holes) (mounts speaker cone)	IH-0000386	3.00
NS.) Screw (M3x3.0mm)(roundhead) (mounts speaker cone bracket to chassis)	IA-0000296	0.15
NS.) Wire harness (black male 7 pin plug) (215.0mm long wires w/ standard tach board) (60.0mm long red & black wires)	BC-0000191	8.00
NS.) Wire harness (black male 5 pin plug)(for motors) (200.0mm & 90.0mm long yellow & white wires)	BC-0000192	5.00
NS.) Wire harness (for speaker) (110.0mm long wires w/ white male 2 pin plug)	BC-0000138	3.00

NS.)	Wire harness (90.0mm long wires w/ black male 2 pin plug) (black wire shield on wires)(for Proto-Coupler®)	BC-1100008	4.00
NS.)	Wire harness (125.0mm long red & black wires w/ eyelets) (has black wire shield on wires) (power supply from pick-ups)	BC-0000193	4.00
NS.)	Wire harness (black male 12 pin plug) (115.0mm long wires w/ small volume pot) (65.0mm long black wire w/ black female 2 pin plug) (90.0mm long brown wire w/ large switch) (60.0mm long wires w/ white female 2 pin plug) (100.0mm long green wire w/ black female 4 pin plug) (165.0mm long light blue wire)	BC-2200075	16.00

Loco-Sound™ Only Parts

41.)	Speaker (Unison) (U4508BSR, 8 ohms, 0.9 watts)	BF-4500013	8.95
45.)	Spring (nickel) (6.5x9.0mm)(0.4mm thick wire)	IE-0000009	0.50
46.)	Washer (black)(plastic) (4.6x8.5x0.5mm)(cup shaped for spring to fit in)	ID-0000060	0.15
NS.)	Coupler (black) (mechanical)(44.0mm long)	DD-0000003	3.00
NS.)	Armature (black) (37.8mm long)	DD-0000010	1.00
NS.)	Board (Loco-Sound®)(DIESEL/ELECTRIC)	AE-0000002	*100.00
NS.)	Bracket (Aluminum) (14.0x63.0mm)(24.0mm step) (for mounting Loco-Sound® board)	IH-0000387	3.00
NS.	Wire harness (black male 5 pin plug)(for motors) (170.0mm & 170.0mm long yellow & white wires)	BC-0000194	5.00
NS.)	Wire harness (black male 12 pin plug) (115.0mm long wires w/ small volume pot) (50.0mm long wires w/ white female 2 pin plug) (170.0mm long light blue wire) (140.0mm long purple wire)	BC-2200076	12.00

*Requires Exchange
All parts are priced as each

F-3 Diesel Locomotive Engine Parts

F-3 A Unit Diesel Engine Engine Parts

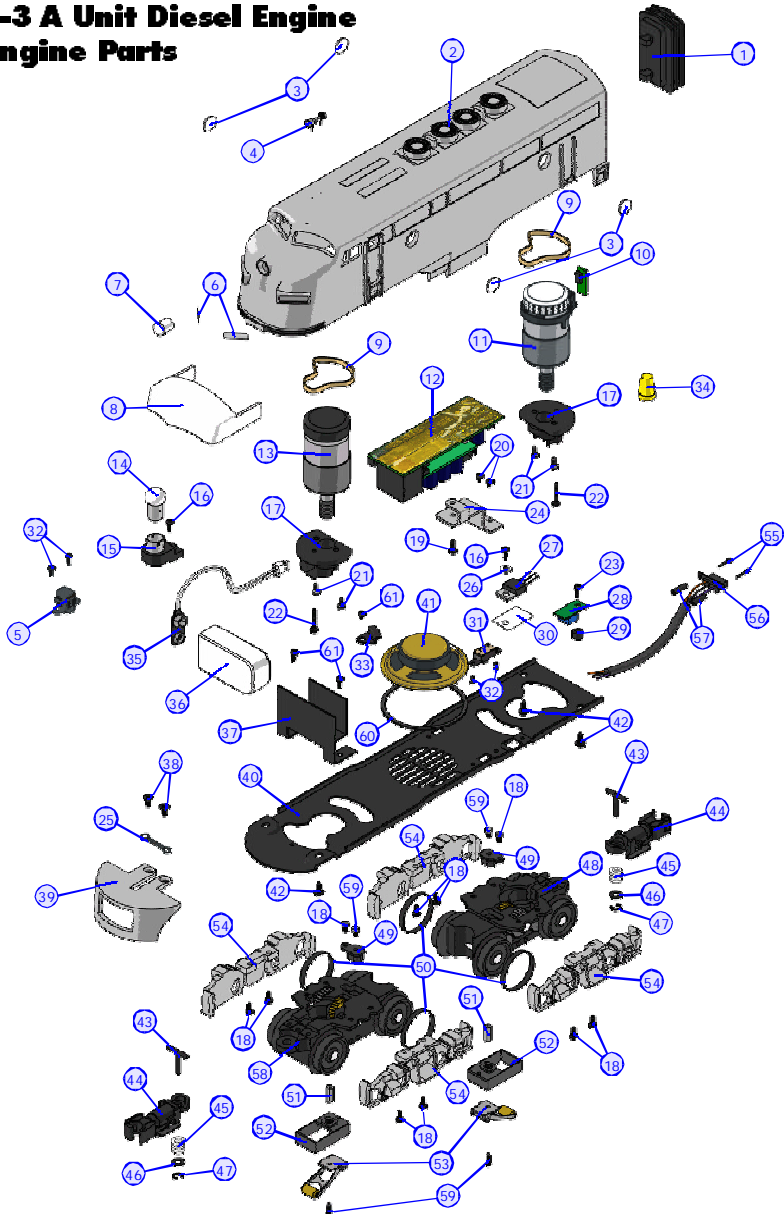

Service & Warranty Information

How to Get Service Under the Terms of the Limited One-Year Warranty

When you suspect an item is defective, please check the operator's manual for standard operation and trouble-shooting techniques that may correct the problem. Additional information may be found on the M.T.H. Website. Should you still require service, follow the instructions below to obtain warranty service.

First, e-mail, write, call or fax a M.T.H. Authorized Service Center (ASC) in your area to obtain Repair Authorization. You can find the list of ASCs on the M.T.H. Website, www.mth-railking.com. Authorized Service Centers are required to make warranty repairs on items sold *only* from that store; all other repairs may -- or may not be done at the store's own discretion. If you did not purchase the item directly from the ASC, you will need to select a National Authorized Service Center (NASC). These centers are compensated by M.T.H. to perform warranty service for any customer whose repair qualifies for warranty service. A list of NASC retailers can be located on the M.T.H. Website or by calling 1-888-640-3700. Should the warranty no longer apply, you may choose either an ASC or NASC retailer to service your M.T.H. Product. A reasonable service fee will be charged.

CAUTION: Make sure the product is packed in its original factory packaging including its foam and plastic wrapping material to prevent damage to the merchandise. There is no need to return the entire set if only one of the components is in need of repair *unless otherwise instructed by the Service Center. The shipment must be prepaid and we recommend that it be insured. A cover letter including your name, address, daytime phone number, e-mail address (if available), Return Authorization number (if required by the service center, a copy of your sales receipt and a full description of the problem must be included to facilitate the repairs. Please include the description regardless of whether you discussed the problem with a service technician when contacting the Service Center for your Return Authorization.*

Please make sure you have followed the instructions carefully before returning any merchandise for service. Authorized M.T.H. Service Centers are independently owned and operated and are not agents or representatives of M.T.H. Electric Trains. M.T.H. assumes no responsibility, financial or otherwise, for material left in their possession, or work done, by privately owned M.T.H. Authorized Service Centers.

If you need assistance at any time email MTH Service at service@mth-railking.com, or call 1-888-640-3700.

Limited One-Year Warranty

All M.T.H. products purchased from an Authorized M.T.H. Train Merchant are covered by this warranty.

See our website at www.mth-railking.com or call 1-888-640-3700 to identify an Authorized M.T.H. Train Merchant near you.

M.T.H. products are warranted for one year from the date of purchase against defects in material or workmanship, excluding wear items such as light bulbs, pick-up rollers, batteries, smoke unit wicks, and traction tires. We will repair or replace (at our option) the defective part without charge for the parts or labor, if the item is returned to an M.T.H. Authorized Service Center (ASC) or M.T.H. National Authorized Service Center (NASC) within one year of the original date of purchase. This warranty does not cover damages caused by improper care, handling, or use. Transportation costs incurred by the customer are not covered under this warranty.

Items sent for repair must be accompanied by a return authorization number, a description of the problem, and a **copy of the original sales receipt from an Authorized M.T.H. Train Merchant**, which gives the date of purchase. If you are sending this product to an Authorized Service Center, contact that Center for their return authorization.

This warranty gives you specific legal rights, and you may have other rights that vary from state to state. If you have any questions regarding the warranty, they may be forwarded to M.T.H. directly.

Service Department
M.T.H. Electric Trains
7020 Columbia Gateway Drive



www.railking.com



AUTHORIZED SERVICE CENTER

7020 Columbia Gateway Dr. - Columbia, MD 21046

Information: 410-381-2580 Fax: 410-381-6122

www.mth-railking.com

PARTICIPATING N.A.S.C. RETAILER LIST

CANADA

TOYTRAIN WORKSHOP
CUMBERLAND
613-833-3125

THETRAINROOM
ERGUS
519-787-3280

CALIFORNIA
TINPLATEJUNCTION
OAKLAND
510-444-4780

COLORADO
MIZELLTRAINSINC
WESTMINSTER
303-429-4811

CONNECTICUT
NEW ENGLANDHOBBY
SUPPLY
MANCHESTER
860-646-0610

FLORIDA
ROUNDHOUSEOUTH
PORTORANGE
386-304-7002

MARYLAND
PLAZA HOBBY
CUMBERLAND
301-729-6424

ENGINE HOUSEHOBBIES
GATHERSBURG
301-590-0816

CATOCTINMOUNTAINTRAINS
THURMONT
301-694-8331

MICHIGAN
MICHIGANMODELTRAIN
CENTER
PINCKNEY
734-426-1651

BRASSEUR ELECTRICTRAINS,
INC.
SAGINAW
989-793-4753

NEW HAMPSHIRE
TREASUREDTOYS
SALEM
603-898-7224

NEW YORK
AURORARAILS&HOBBIES
EAST AURORA
716-652-5718

OHIO
DAVISELECTRONICS
MILFORD
513-831-6425

RICK'STOYTRAINS
TOLEDO
419-478-0171

PENNSYLVANIA
BUSSINGERTRAINS
AMBLER
215-628-2366

FAIRCHANCEPHARMACY
FAIRCHANCE
724-564-7817

THESTATION
NEWCUMBERLAND
717-774-7096

VIRGINIA
LOCUST GROVETRAINS
LOCUST GROVE
540-854-8955

DAVIS HOBBYSUPPLIES
PORTSMOUTH
757-397-1983

T S G HOBBIES
WARRENTON
540-347-9212

WISCONSIN
SOMMERFELD'STRAINS
BUTLER
262-783-7797

GRAMPA'STRAINSHOP
RICELAKE
715-234-2996



AUTHORIZED SERVICE CENTER

7020 Columbia Gateway Dr. - Columbia, MD 21046

Information: 410-381-2580 Fax: 410-381-6122

www.mth-railking.com

PARTICIPATING A.S.C. RETAILER LIST

CANADA

TOYTRAIN WORKSHOP
CUMBERLAND
613-833-3125

THETRAINROOM
ERGUS
519-787-3280

CREDITVALLEYRAILWAY
COMPANY
STREETSVILLE
905-826-1306

B&HTRAINS
TERREBONNE, QUEBEC
450-492-0317

ALABAMA
SOUTHERLANDSTATION
HUNTSVILLE
256-533-4720

LIL'BOBBY'SHOBBIES
MONTGOMERY
334-277-1715

ARIZONA
ARIZONA TRAINDEPOT
MESA
480-833-9486

CENTRALCOASTTRAINS
ATASCEDERO
805-466-1391

CALIFORNIA
CENTRALCOASTTRAINS
ATASCEDERO
805-466-1391

TRAINSHACK
BURBANK
818-842-3330

ROUNDHOUSE
NORTHHOLLYWOOD
818-769-0403

DOLLHOUSES, TRAINS &
MORE
NOVATO
415-883-0388

TIN PLATEJUNCTION
OAKLAND
510-444-4780

RON'SWORLD
SAN CLEMENTE
949-361-5596

TRUCKS&TRAINSHOBBIES
SANTAROSA
707-537-6586

COLORADO
CUSTOMRAILWAYSUPPLY
COLORADOSPRINGS
719-634-4616

MIZELLTRAINSINC
WESTMINSTER
303-429-4811

CONNECTICUT
NEW ENGLANDHOBBY
SUPPLY
MANCHESTER
860-646-0610

DELAWARE
KRRBMODELTRAINSINC.
NEWARK
302-292-2779

FLORIDA
HOLLYWOODSTATION
HOLLYWOOD
954-921-2700

DEPOTHOBBYSHOP
LAKEWORTH
561-585-1982
READYTOROLL
MIAMI
305-688-8868

FRANK'STRAINS&HOBBIES
INC.
OLDSMAR
813-855-1041

COLONIAL PHOTO & HOBBY
ORLANDO
407-841-1485

WARRICKCUSTOMHOBBIES
PLANTATION
954-370-0708

ROUNDHOUSE SOUTH
PORT ORANGE
386-304-7002

ILLINOIS
BIKE&CHOOCHOO
CONNECTION
SCHAUMBURG
847-882-7728

INDIANA
Y.O.R.K.TRAINS
MUNSTER
219-838-9999

SAMUELSON'STRAINSHOP
VALPARAISO
219-462-2708

IOWA
CABOOSESTOPHOBBIES
CEDAR FALLS
800-642-7012

KENTUCKY
L&N TRAINS & THINGS
LOUISVILLE
502-897-9005

LOUISIANA
AMERICA'S TRAIN YARD
BATON ROUGE
225-926-5592

MAINE
WHEELS, WINGS & THINGS
LUDLOW
207-532-6277

MARYLAND
PLAZA HOBBY
CUMBERLAND
301-729-6424

HOBBYTOWN U S A
FREDERICK
301-694-7395

ENGINE HOUSE HOBBIES
GAITHERSBURG
301-590-0816

J & B TRAINS
HAGERSTOWN
240-420-4930

THE TRAIN ROOM
HAGERSTOWN
301-745-6681

PURKEY'S TOY TRAINS
SYKESVILLE
410-549-6061

CATOC TIN MOUNTAIN TRAINS
THURMONT
301-694-8331

N & W TRAINS HED
WILLIAMSPORT
301-223-8801

MASSACHUSETTS
NORTHEAST TRAINS
PEABODY
978-532-1615
EAST BAY HOBBIES
SEEKONK
508-336-5573

MICHIGAN
MICHIGAN MODEL TRAIN
CENTER
PINCKNEY
734-426-1651

BRASSEUR ELECTRIC TRAINS,
INC.
SAGINAW
989-793-4753

MISSOURI
SWITCHSTAND
SAINT LOUIS
314-781-4458

MARK TWAIN HOBBY CENTER
ST. CHARLES
636-946-2816

NEVADA
RENO RAILS
RENO
775-337-6669

NEW HAMPSHIRE
RAILROAD SPECIALTIES
NASHUA
603-801-0801

TREASURED TOYS
SALEM
603-898-7224

NEW JERSEY
COUNTRY AND STUFF
ANDOVER
973-786-7086

COLUMBUS TRAIN STATION
COLUMBUS
609-518-1800

ATLANTIC RAILS
HAMMONTON
609-567-8490

GRAND CENTRAL STATION
KEARNY
201-955-6200

J & B TRAINS, INC.
MAPLE SHADE
856-414-0092

HOBBY SHOP
MATAWAN
732-583-0505

HOBBY MASTERS, INC
REDBANK
732-842-6020

RIDGEFIELD HOBBY
RIDGEFIELD
201-943-2636

TRAINS & THINGS
TRENTON
609-883-8790

COAST TRAINS AND
COLLECTIBLES
WALL
732-556-9005

HOLLY BEACH TRAIN DEPOT
WILDWOOD
609-522-2379

NEW YORK
AURORA RAILS & HOBBIES
EAST AURORA
716-652-5718

NASSAU HOBBY CENTER, INC.
FREEPORT
516-378-9594

HOBBY WORLD
MONTICELLO
845-794-8770

CITY DEPOT, INC.
NEW HAMPTON
845-374-3010

AMERICAN STORE
TIVOLI
845-757-4246

KROSS HARDWARE
WEST BABYLON
631-669-3069

NORTH CAROLINA
THE ROUNDHOUSE &
BACKSHOP
CARY
919-465-0810

TRAINS LTD.
CHARLOTTE
704-566-9070

DRY BRIDGE STATION
MOUNTAIRY
336-786-9811

THE FREIGHTYARD
SMITHFIELD
919-934-6229

TRAIN LOFT
WINSTON-SALEM
336-760-9817

OHIO
GLEN'S TRAIN SHOP
AKRON
330-253-6527

E & S TRAINS
AKRON
330-745-0785

T & K HOBBY SHOP
BRIDGEPORT
740-633-6607

SCHAFFNER'S TRAINS
CANTON
330-452-4444

TRAINS-N-THINGS
CANTON
330-499-1666

PARMA HOBBY
CLEVELAND
216-741-6440

SANDY'SHOBBY'S&
COLLECTIBLES
ELYRIA
440-365-9999

HUDSONTOY,TRAIN&
HOBBY
HUDSON
330-653-2997

CLEARVIEW TRAIN&HOBBY
LORAIN
440-277-4488

DIXIEUNIONSTATION
MASON
513-459-0460

DAVISELECTRONICS
MILFORD
513-831-6425

GRANDPACIFICJUNCTION
OLMSTEAD FALLS
440-235-4777

RICK'STOYTRAINS
TOLEDO
419-478-0171

ERIERAILWAYDEPOT
TROY
937-440-9972

PENNSYLVANIA
AMERICANHOBBY CENTER
ALIQUIPPA
724-378-3930

ALLENTOWNTOYTRAIN
SERVICE
ALLENTOWN
610-821-0740

ONTHERIGHTTRACK
ALTOONA
814-942-4345

BUSSINGERTRAINS
AMBLER
215-628-2366

YEOLDETRAIN&CHRISTMAS
SHOPPE
BOYERTOWN
610-369-0755

CHARLEROI SWEEPER
CENTER
CHARLEROI
724-483-3397

CRANBERRYHOBBYDEPOT
CRANBERRYTPW
724-776-3640

FAIRCHANCE PHARMACY
FAIRCHANCE
724-564-7817

TOY TRAINSTATION
FEASTERVILLETRV
215-322-5182

THECABOOSE
LEHIGHTON
570-386-5352

HOBBYCITY
McMURRAY
724-942-2557

THESTATION
NEWCUMBERLAND
717-774-7096

FRYER'SSTORE
ORWIGSBURG
570-366-2258
CHESTNUTTOYBOX
PHILADELPHIA
215-545-0455

TOBYTYLER'SHOBBY
CENTER
PITTSBURGH
412-653-5030

C.T.MCCORMICKHARDWARE
ZELIENOPE
724-452-6130

SOUTHCAROLINA
EMERALDTRAIN & HOBBY
GREENWOOD
864-223-2247

TENNESSEE
MODEL RAILROAD & HOBBY
SHOP
MEMPHIS
901-384-6500

TEXAS
HOBBYTIME
AMARILLO
806.352.9660

RIVERVIEWTRAINS
ANGLETON
979-848-3895

GREATTRAINS&HOBBIES
LONGVIEW
903-757-2720

VIRGINIA
LOCUST GROVETRAINS
LOCUST GROVE
540-854-8955

TRAINS,ETC.
LORTON
703-550-1779

TRAINDEPOT
MANASSAS
703-335-2216

CHESTERFIELDHOBBIES
MIDLOTHIAN
804-379-9091

DAVISHOBBYSUPPLIES
PORTSMOUTH
757-397-1983

TOYTRAINCENTER
RICHMOND
804-288-4475

TSGHOBBIES
WARRENTON
540-347-9212

NORGE STATION
WILLIAMSBURG
757-564-7623

WESTVIRGINIA
PATRICK'STRAINS
WHEELING
304-232-0714

WISCONSIN
SOMMERFELD'STRAINS
BUTLER
262-783-7797

WOODCRAFTER'S
BURLINGTON
262-763-5239

HOBBY OUTLET
FONDDULAC
920-924-3770

GB TV & TRAINS
GREENBAY
920-496-9697

GRAMPA'STRAIN SHOP
RICELAKE
715-234-2996

THETRAINSTORE
WAUKESHA
262-650-6675