

*RAILKING*  
**READY-TO-RUN™**  
*sets*  
**THE COMPLETE SOLUTION**

[www.railking.com](http://www.railking.com)

# Union Pacific 2-8-0 Steam Freight Set

## Operation Manual



**DLS**  
**PROTO-SOUND**  
**DIGITAL COMMAND SYSTEM**

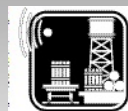

**RAILKING®**  
By MTH Electric Trains

Thank you for purchasing this RailKing product.  
**PLEASE READ BEFORE USE AND SAVE**

# Table of Contents

<b>Set Up Checklist</b> .....	<b>3</b>
<b>Getting Started</b> .....	<b>4</b>
Assembling RealTrax .....	4
Installing the Lock-on .....	4
Connecting the Transformer .....	4
Lubricating the Engine .....	5
Priming the Smoke Unit .....	5
Coupling the Engine and Cars .....	5
Remote Control .....	6
Checking the Battery .....	6
<b>Basic Operation</b> .....	<b>7</b>
Operation Buttons .....	7
Manual Volume Control .....	7
<b>Proto-Sound 2.0 Operation</b> .....	<b>8</b>
Activating Proto-Sound 2.0 Conventional Mode Features .....	8
Freight Yard Sounds (FYS) .....	8
Tips on Using FYS .....	9
Proto-Coupler® Operation .....	9
Speed Control .....	10
Lock into a Direction .....	10
Reset to Factory Defaults .....	10
Automatic Sounds .....	11
<b>Maintenance</b> .....	<b>12</b>
Care of Remote Control .....	12
Lubrication and Greasing Instructions .....	12
Cleaning the Wheels, Tires and Track .....	13
Locomotive Traction Tire Replacement .....	13
Smoke Unit Maintenance .....	13
Locomotive Light Bulb Replacement .....	14
Caboose Light Bulb Replacement .....	15
Self-Charging Battery Back-Up .....	16
<b>RailWare Interactive CD ROM</b> .....	<b>17</b>
<b>Troubleshooting</b> .....	<b>18</b>
<b>Compatibility</b> .....	<b>20</b>
<b>Transformer Compatibility Chart</b> .....	<b>20</b>
<b>Additional Features with DCS Remote Control System</b> .....	<b>21</b>
<b>Exploded View Parts</b> .....	<b>22</b>
<b>Service and Warranty Information</b>	

**CAUTION: ELECTRICALLY OPERATED PRODUCT:**

Not recommended for children under 10 years of age. M.T.H. recommends adult supervision with children ages 10 - 16. As with all electric products, precautions should be observed during handling and use to reduce the risk of electric shock.

**WARNING:** When using electrical products, basic safety precautions should be observed, including the following: Read this manual thoroughly before using this device.

- M.T.H. recommends that all users and persons supervising use examine the hobby transformer and other electronic equipment periodically for conditions that may result in the risk of fire, electric shock, or injury to persons, such as damage to the primary cord, plug blades, housing, output jacks or other parts. In the event such conditions exist, the train set should not be used until properly repaired.
- Do not operate your layout unattended. Obstructed accessories or stalled trains may overheat, resulting in damage to your layout.
- This train set is intended for indoor use. Do not use if water is present. Serious injury or fatality may result.
- Do not operate the hobby transformer with damaged cord, plug, switches, buttons or case.
- The transformer was designed to operate on regular US household current (120 volt, 50-60 Hertz). Do not connect to any other source of power.
- To avoid the risk of electrical shock, do not disassemble the transformer unit. There are no user-serviceable parts inside. If the unit is damaged contact M.T.H. Service for instructions.
- The transformer is equipped with an internal circuit protector. If the circuit protector trips, unplug the power cord from the electrical wall outlet, check your layout for any short circuits. The circuit breaker will reset automatically when the short is removed from the circuit.
- Unplug the transformer from the electrical wall outlet when not in use.
- Do not use this transformer for other than its intended purpose.

**Transformer Ratings:**

Input: 120 VAC, 60 Hz Only Output: 21VAC, 3.75A78VA

# Set Up Checklist

- Assemble RealTrax®
- Connect the transformer
- Lubricate the engine
- Priming the Smoke Unit
- Place the engine and cars on the track and couple them together
- Check to see whether the battery needs to be charged for full sound effects
- Apply power to run as described in the Basic Operation section of these instructions.

## Set Includes

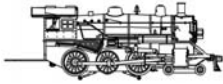

Steam Engine with Proto-Sound® 2.0



Steam Tender



8-Pieces  
O-31 Curve RealTrax



Box Car



Lock-On

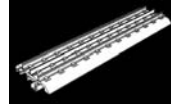

4-Pieces  
Straight RealTrax

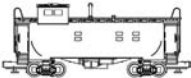

Caboose

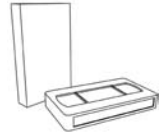

Video

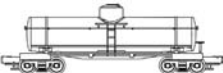

Tank Car



Remote Control

or

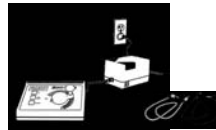

Controller with Wiring Harness

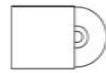

CD-Rom

## Tools Needed

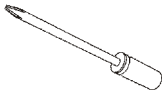

Phillips Screwdriver



Pliers



Scissors



Cotton Swab or Rag



RailKing Maintenance Kit or  
Light Household Oil and Bearing Grease

**You can obtain replacement parts and replacement instructions from the M.T.H. Parts Department**

e-mail: [parts@meth-railking.com](mailto:parts@meth-railking.com)

phone: 410-381-2580

mail: 7020 Columbia Gateway Drive, Columbia MD 21046-1532

# Getting Started

## Assembling RealTrax®

The quick connectors and built-in roadbed allow you to set up RealTrax anywhere, including carpeted surfaces.

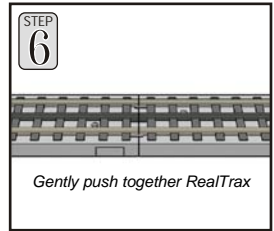
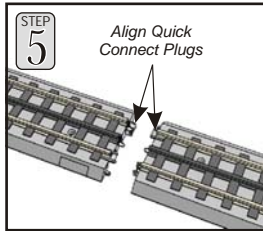
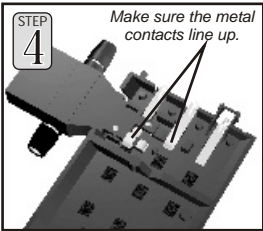
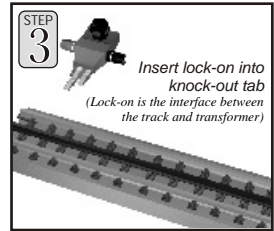
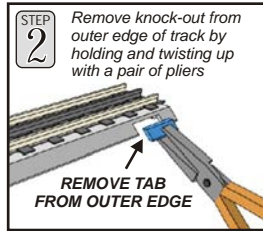
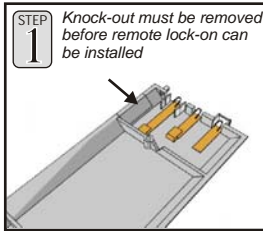

### Connecting Track Clips

If you prefer not to screw your track to the table for a permanent layout, use the enclosed track clips on adjoining curved RealTrax sections to secure them in place.

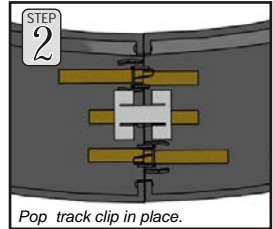
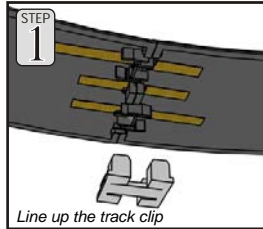

### Connecting the Transformer

The 75-watt power supply included with this set provides an easy-to-use, safe power source for AC-powered trains and accessories.

- Plug the wire from the transformer into the remote lock-on's center port, then plug the transformer into the wall outlet.
- Unplug when not in use.

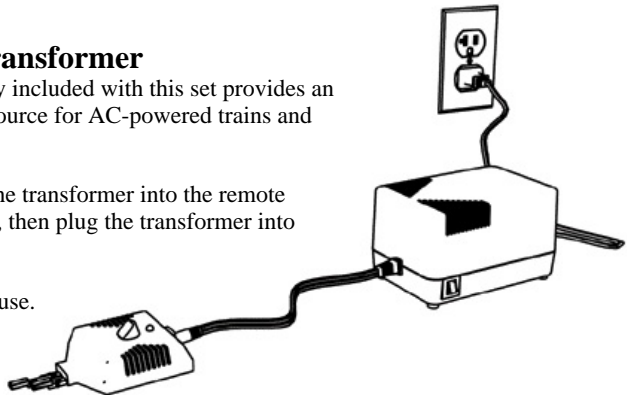

## Lubricating the Engine

Lubricate all exposed moving parts before operating using a multi-purpose, plastic-compatible oil (available with M.T.H.'s Maintenance Kit, sold separately) or a light household oil. Follow the lubrication points.

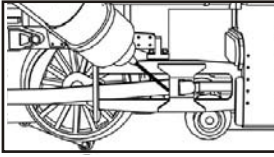

Lubricate Valve Gear

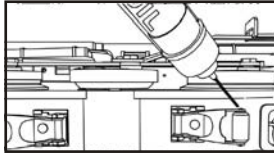

Lubricate Pick-Up Rollers  
(Do Not Oil the Flat Part of Pick-Up Rollers)

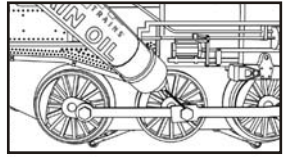

Lubricate Side Rods

## Priming the Smoke Unit

You should prime the smoke unit with smoke fluid before operating. Add 15-20 drops of smoke fluid from the included pipette through the smokestack, then gently blow into the stack to eliminate any air bubbles in the fluid.

If you choose not to prime the unit with fluid, turn the smoke unit switch located under the tender to the OFF position. **Running the engine without a primed smoke unit may cause damage.** See the "ProtoSmoke Unit Operation" section of this book for more information on smoke unit maintenance.

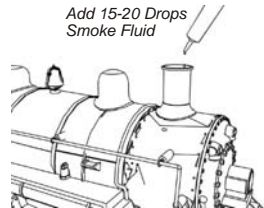

Add 15-20 Drops  
Smoke Fluid

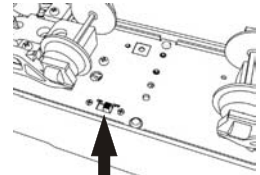

Smoke Unit  
ON/OFF Switch



**Running the engine without a primed smoke unit may cause damage**

## Coupling the Engine and Cars

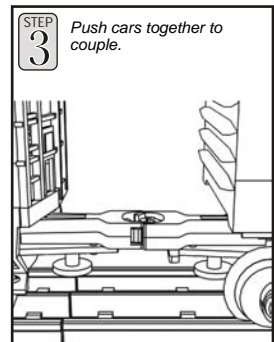
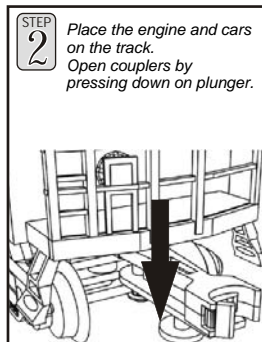
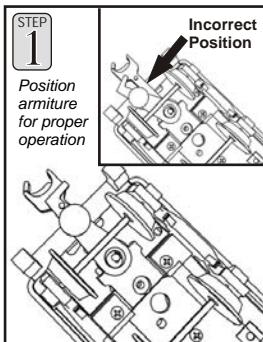

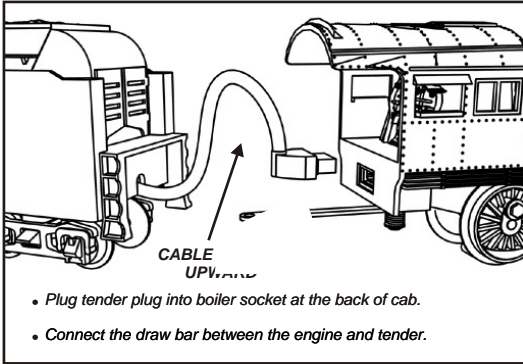

**! DO NOT CONNECT This Engine To A Tender From Another Engine; It May Cause Serious Damage.**

*Look at the bottom of the engine and tender where each will have a color-coded stamp. If they match you may connect those two pieces; if not, don't.*

## Checking the Battery

You may find, if your set was built several months before you set it up, that the rechargeable battery has run down and needs to be charged before operating. If you notice that the sounds are garbled, test and charge the engine as described in the "Self-Charging Battery Back-Up" on page 16.

## Remote Control

The remote and lock-on are designed for use with moderate power supplies such as the one included with this set. It is compatible with virtually any manufacturer's engines.

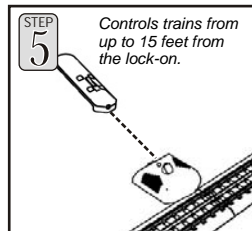
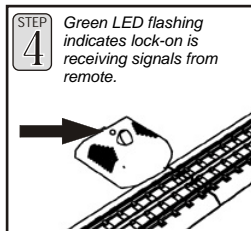
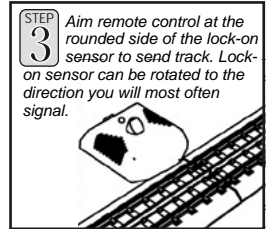
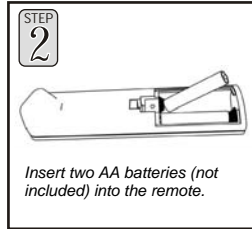
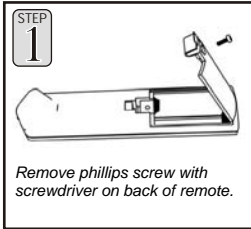

**Note:** The RailKing® Remote Control and Remote Lock-on will not operate engines equipped with pre-1997 versions of Proto-Sound® or with Proto-One,™ Proto-Plus,™ Proto-Deluxe,™ aftermarket systems.

# Basic Operation

## Operation Buttons

**Throttle Up** Throttle up the power to your track by pressing the top end of the Throttle Control Rocker Switch firmly for about 5 seconds, until the engine's headlight and lighted cars burn bright. Then put the engine into motion by firmly pressing the Direction button (hold it for approximately 1 second) on your remote once. If the engine does not begin to move as soon as you firmly press the Direction button, you may not have sent enough voltage to the track to make the train move. Press the throttle up for a few more seconds until the train begins to move. To increase or decrease track voltage, and therefore train speed, press the throttle control rocker switch. Pressing the top end of the throttle will increase voltage and speed. Pressing the bottom end of the throttle will decrease voltage and speed. The engine will maintain the speed you set after you release the throttle until you press it again to change the voltage and speed.

**Bell** - To sound the bell, firmly press and release the Bell button. To turn the bell off, press and release the Bell button again. The bell will continue to ring from the time you turn it on until you press and release the button again to turn it off.

**Emergency Stop** Press the Emergency Stop button and all trains on the track controlled by the remote will stop until you reapply voltage. This is an easy way to shut down your trains at the end of a session or to stop suddenly the train's path becomes obstructed.

**CAUTION:** Do not mix old and new batteries. Do not mix alkaline, standard (carbon-zinc), or rechargeable (nickel-cadmium) batteries.

## Manual Volume Control

To adjust the volume of all sounds made by this engine, turn the master volume control knob located under the tender clockwise to increase the volume and counter-clockwise to decrease the volume.

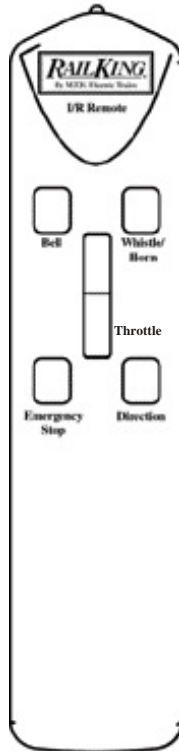

**Horn/Whistle** - To sound the whistle, firmly press the Horn/Whistle button. The whistle will sound for as long as you continue to depress the button. It will stop when you release the button.

**Direction** Your train is programmed to start in neutral. The train will always cycle neutral-forward-neutral-reverse with each press and release of the direction button. The engine is programmed to restart in neutral each time the track voltage is turned off for 25 seconds or more.

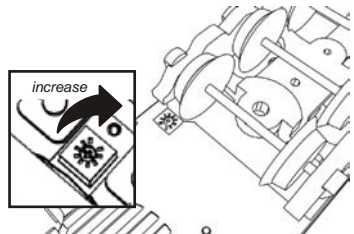
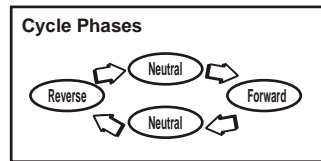

# Proto-Sound 2.0 Operating Instructions

This manual contains the operating instructions for Proto-Sound 2.0 in conventional mode only. Instructions for accessing DCS command mode features accompany the DCS Remote Control System equipment.

## Activating Proto-Sound 2.0 Conventional Mode Features:

Proto-Sound 2.0 features are activated by sequences of Bell and Whistle button pushes described below. Please read the full descriptions of each feature before using it. To use these buttons to activate features rather than to blow the whistle or ring the bell, you should tap the buttons very quickly with a ½-second pause between button presses. You may need to practice your timing to make this work smoothly.

Timing Chart				
Press Whistle Short & Firm	½ Sec. Pause	Press Bell Short & Firm	½ Sec. Pause	Press Bell Short & Firm
Total Time Lapse: 1 ½ Seconds				

Feature to Be Activated	Button Code:
Freight Yard Sounds	1 Bell, 2 Whistles
Fire the Rear Coupler	1 Bell, 3 Whistles
Fire the Front Coupler	1 Bell, 4 Whistles
Speed Control On/Off	1 Whistle, 2 Bells (from Neutral only)
Lock into a Direction	1 Whistle, 3 Bells
Reset to Factory Defaults	1 Whistle, 5 Bells (from Neutral only)

## Freight Yard Sounds (FYS):

Your engine is equipped with a sound package of freight yard sounds that you can play when you pull into a yard. **Each sequence described below will play as long as it is left on, randomly generating sounds, but be sure to allow approximately 30 seconds between the button pushes described below to allow the FYS sufficient time to run through each sequence.**

- To cue the sound system to play the FYS, quickly but firmly tap the Bell button once followed by 2 quick taps of the Whistle button while the engine is moving. Tap the buttons quickly but allow approximately ½ second between each press.
- Press the Direction button once to stop the engine. This will trigger the first sequence of FYS. The reverse unit is temporarily disabled so that the train will not move as you use the Direction button to trigger the sounds, and Proto-Sound 2.0 has disabled operator control over the Whistle and Bell buttons until the full FYS sequence is complete.
- After waiting about 30 seconds for that sequence to run, press the Direction button again to trigger the second sequence of FYS.
- After about 30 seconds, press the Direction button again to trigger the third FYS sequence.



- Again, after allowing about 30 seconds for that sequence to run, press the Direction button one more time to trigger the fourth and final FYS sequence. The FYS will continue, and within a few seconds, the engine will start and move out on its own at the current throttle setting, in the same direction it was traveling when you began the sequence. Once the bell turns off, the operator regains control of the transformer's Bell and Whistle buttons and can ring the bell or blow the whistle as usual.

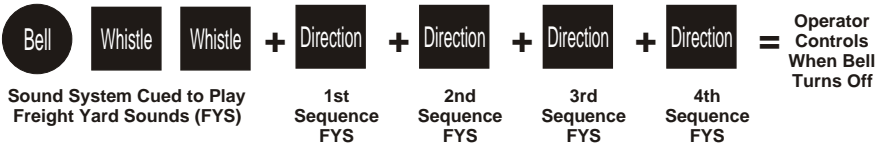

## Tips on Using FYS

- You can terminate FYS at any time by turning off power to the track for 15 seconds.
- You do not have to be in Forward to use FYS. At the conclusion of the full sequence, the train will pull away from the station in whatever direction you were going when you activated the feature.
- You can use FYS even if you are double-heading with another engine. If the second engine is not equipped with Proto-Sound 2.0, you must remember not to leave the throttle at a high voltage level once you have stopped the engine to run the FYS. Otherwise, the engine without FYS will begin vibrating on the track as its motors strain to move the train, since they cannot be automatically disabled during the FYS cycle (or if an original Proto-Sound engine, FYS are triggered differently and that engine's motor-disable feature will not be active when you run FYS in Proto-Sound 2.0).
- FYS can be triggered from Neutral. It will operate the same as if triggered while in motion except that, at the conclusion of the FYS, the engine will depart in the next direction of travel, as opposed to the direction it was traveling before entering Neutral.

## Proto-Coupler<sup>®</sup> Operation

This locomotive is equipped with one or more coil-wound Proto-Couplers for remote uncoupling action. Because Proto-Couplers are controlled through the Proto-Sound 2.0 microprocessor, they do not require an uncoupling track section or modification to your layout to function. You can fire a coupler from neutral or while in motion. Use the code shown below (and in the chart on page 8) to fire the coupler(s).

### Rear Coupler:

To fire the rear coupler, quickly tap the Bell button once followed by three quick taps of the Whistle button, allowing approximately ½ second to lapse between each quick button press. The sound of the liftbar and air line depletion will play, and the knuckle will be released.



## Front Coupler:

To fire the front coupler (if your engine has one), quickly tap the Bell button once followed by four quick taps of the Whistle button, allowing approximately ½ second to lapse between each quick button press. The sound of the liftbar and air line depletion will play, and the knuckle will be released.



## Speed Control:

M.T.H. engines equipped with Proto-Sound 2.0 have speed control capabilities that allow the engine to maintain a constant speed up and down grades and around curves, much like an automobile cruise control. You can add or drop cars on the run, and the engine will maintain the speed you set.

While the engine is programmed to start with the speed control feature activated, you can opt to turn it off. This means the engine's speed will fall as it labors up a hill and increase as it travels downward. It is also affected by the addition or releasing of cars while on the run. Because the engine will run more slowly at a given throttle voltage when speed control is on than when it is off, you should adjust the throttle to a lower power level for operation with speed control off to avoid high-speed derailments. When speed control is off, the volume will drop to allow for better low voltage operation.

To turn speed control on and off, put the engine in neutral, then quickly tap the transformer's whistle button one time then quickly tap the Bell button two times, allowing approximately ½ second to lapse between each quick button press. Repeat the 1 whistle, 2 bells code to return it to the other condition. You will want to do this during the initial neutral upon start-up if you ever couple this engine to another engine that is not equipped with speed control to avoid damaging the motors in either engine. Each time you shut down the engine completely, it will automatically turn speed control on.



## Lock into a Direction:

You can lock your engine into a direction (forward, neutral, or reverse) so that it will not change directions. To do this, put the engine into the direction you want (or into neutral to lock it into neutral), run it at a very slow crawl (as slowly as it will move without halting), and quickly but firmly tap the Whistle button once followed by three quick taps of the Bell button, allowing approximately ½ second to lapse between each quick button press. Two whistle blasts will indicate that the engine has made the change. The engine will not change direction (including going into neutral) until you repeat the 1 whistle, 3 bells code to return the engine to its normal condition, even if the engine is kept without power for extended periods of time.



### Reset to Factory Defaults:

To override the settings you currently have assigned to the engine and reset it to its factory defaults, while in Neutral tap the Whistle button quickly once, followed by five quick taps of the Bell button, allowing approximately ½ second to lapse between each quick button press. Two whistle blasts will indicate that the engine has made the change.



### Automatic Sounds:

Certain Proto-Sound 2.0 sound effects automatically play in programmed conventional mode conditions:

- **Squealing Brakes** play any time the engine's speed decreases rapidly.
- **Cab Chatter** plays at random intervals when the engine idles in neutral.
- **Engine Start-up and Shut-down** sounds play when the engine is initially powered on or is powered off for five seconds or more.

# Maintenance

## Care of the Remote Control

Your RailKing Remote Control System should offer years of trouble-free service. There are a few things you can do to ensure trouble-free operation:

- If your train responds inconsistently, replace old batteries with fresh ones. Do not mix old and new batteries.
- Remove batteries before storing for extended periods.
- Do not drop the remote. It can damage the delicate electronics inside.
- Any attempt by anyone other than an authorized M.T.H. repair person to open and repair the handheld transmitter or lock-on may result in damage and the loss of warranty protection.

## Lubrication Instructions

The engine should be oiled and greased in order to run properly.

Regularly lubricate all side rods and linkage components and pickup rollers to prevent squeaking. Use light household oil, such as that found in M.T.H.'s maintenance kit. Do not over oil. Use only a drop or two on each pivot point.

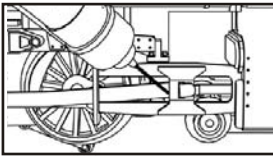

Lubricate Valve Gear

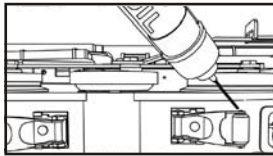

Lubricate Pick-Up Rollers  
(Do Not Oil the Flat Part of  
Pick-Up Rollers)

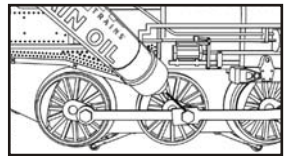

Lubricate Side Rods

## Greasing Instructions

The locomotive's internal gearing was greased at the factory. Grease engine every 50 hours of use or one year. Use a lithium based grease and follow the greasing instructions.

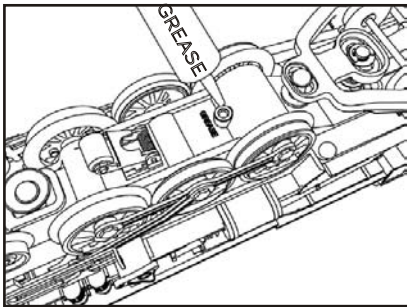

- Remove the screw from the chassis to open the grease port.
- Insert the grease tube tip into the port and squeeze the tube once or twice to add grease to the gearbox.
- Wipe off any excess grease and replace the phillips screw securely.

## Cleaning the Wheels, Tires and Track

Periodically check the locomotive wheels and pickups for dirt and buildup, which can cause poor electrical contact and traction and prematurely wear out the neoprene traction tires. Wheels and tires can be cleaned using denatured (not rubbing) alcohol applied with a cotton swab.



To clean the track, use RailKing Track Cleaning Fluid and a clean rag or denatured (not rubbing) alcohol. Unplug the transformer and wipe the rails of the track, turning the rag frequently to ensure that you are using clean cloth on the rails. Because the manufacturing process leaves a coating on RealTrax center rail, you should clean the rails after the first 30 minutes of use (you may notice an electrical smell during initial use as the coating wears off; this is normal). Thereafter, keep an eye on the track and clean it when it gets dirty to ensure good electrical contact and to lengthen the life of the tires.

## Traction Tire Replacement Instructions

Your locomotive is equipped with two neoprene rubber traction tires on the rear set of flanged drivers. While these tires are extremely durable, you may need to replace them at some point.

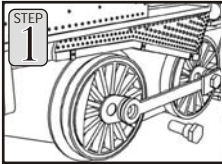

- Remove the side rods (the rods that connect each drive wheel to the other) from the wheels in order to slip the new tire over the grooved drive wheel. These bolts can be loosened with a 5mm nutdriver.
- Clean the groove using a cotton swab and denatured alcohol.

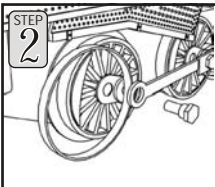

- Make sure the old tire has been completely removed from the groove in the drive wheel, using a razor blade or small flathead screwdriver to pry away any remains.
- Clean the groove using a cotton swab and denatured alcohol.
- Slip the new tire onto the wheel. You may find it useful to use two small flathead screwdrivers to stretch the tire over the wheel.
- If you twist the tire while stretching it over the wheel, you will need to remove and reinstall the tire. Otherwise your engine will wobble while operating.
- Make sure the tire is fully seated inside the groove. Use a razor blade to trim away any excess tire that doesn't seat itself inside the groove properly.

## ProtoSmoke<sup>®</sup> Unit Operation

This steam locomotive contains a smoke unit that outputs smoke through the smokestack on the boiler of the engine. The smoke unit is essentially a small heating element and wick that soaks up and then heats a mineral oil-based fluid that emits a harmless smoke. The smoke is then forced out of the stack by a small electric fan.

With a few easy maintenance steps, you should enjoy trouble-free smoke unit operation for years.

- When preparing to run this engine, add 15-20 drops of smoke fluid through the smokestack. We recommend M.T.H. ProtoSmoke, Seuthe, LGB, or LVTS fluids (a small pipette of ProtoSmoke fluid is included). Do not overfill the unit or the fluid may leak out and coat the interior engine components.

- If you choose not to add the fluid (or have already added the fluid but choose to run smoke-free), turn off the smoke unit switch located under the tender body. **Failure either to add fluid to the unit or to turn it off may damage the smoke unit heating element and/or wicking material.**

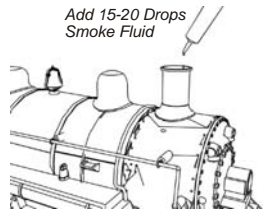

**⚠ Running the engine without a primed smoke unit may cause damage**

- When the smoke output while running the engine begins to diminish, add another 10-15 drops of smoke fluid or turn the smoke unit off.
- When storing the unit for long periods of time, you may want to add about 15 drops of fluid to prevent the wick from drying out.
- After removing the engine from storage, add another 25 drops of fluid, letting the wick soak up the fluid for 15 minutes prior to operation.

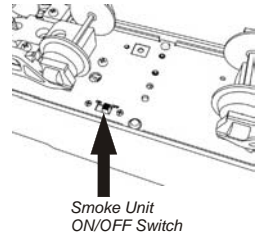

If you experience poor or no smoke output when the smoke unit is on and has fluid, check the wick to see if it has become hard, blackened, and unabsorbent around the heating element. Remove the boiler as shown below. Remove the smoke unit inspection cover from the locomotive's body (see right). After removing the chassis and inspection cover screws, lift the inspection plate away and inspect the wick. If it is darkly discolored and hard, it should be replaced. When priming new wick add 40 drops.



## Locomotive Light Bulb Replacement

To replace the light bulb in the locomotive, follow the boiler removal instructions below.

**STEP 1** Remove the four Phillips screws from the chassis then lift the body away from the chassis.

STEP  
2

Once the locomotive boiler has been removed from its chassis, locate the bulb bracket as seen in the illustration on the right and rotate the headlight bulb counter-clockwise to remove.

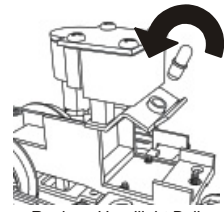

## Caboose Light Bulb Replacement

To replace the interior light bulbs follow these instructions and see the diagrams below.

You can obtain replacement bulbs directly from the M.T.H. Parts Department.

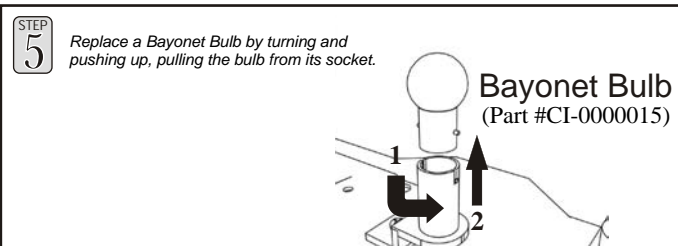
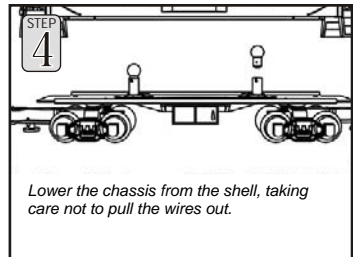
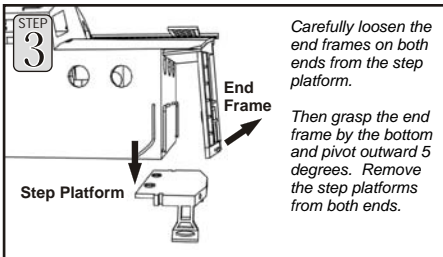
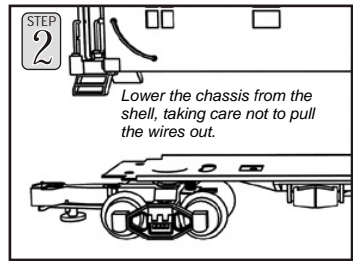
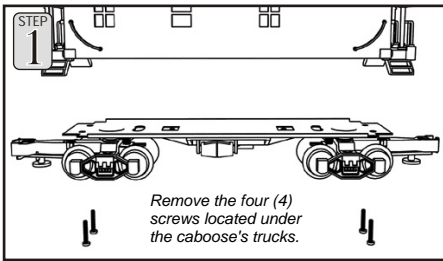

## Self-Charging Battery Back-Up

The special NiCad 7-cell 8.4v self-charging battery recharges continuously during train operation and should last for up to five years. The battery is a dry battery that should not leak or cause any damage to your engine. **Depending upon when your engine was built, it may need to be charged right out of the box.** If engine sounds seem distorted or garbled at low voltages or become silent when power from the transformer is turned off, test the battery to determine whether it should be recharged or replaced.

- **Test:** Put the engine in neutral and leave the track voltage at 10-12 volts (high enough for the lights to shine brightly and the engine to move steadily) for 15 minutes.
- **Recharge:** If the sounds are improved at the end of the 15-minute test charge, the battery charge has run down and can be recharged. There are a number of ways you can do this:
  - Leave the engine in neutral with track voltage at 10-12 volts for 6-7 hours so the battery can fully recharge (if your engine has a smoke unit, be sure it is turned off).
  - Use M.T.H.'s battery recharger (sold separately) that plugs into a wall outlet and a special port under the tender to recharge the battery overnight without leaving it on the track.

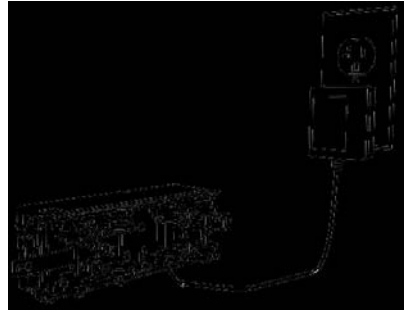

- **Replace:** If the sounds are not improved at the end of the 15-minute test charge, it is time to replace the battery. Available through M.T.H. Parts. A standard 9v alkaline battery can be substituted until your replacement arrives, but since alkaline batteries cannot be recharged, it will eventually wear down. **Do NOT use a 6-cell 7.2v battery.**

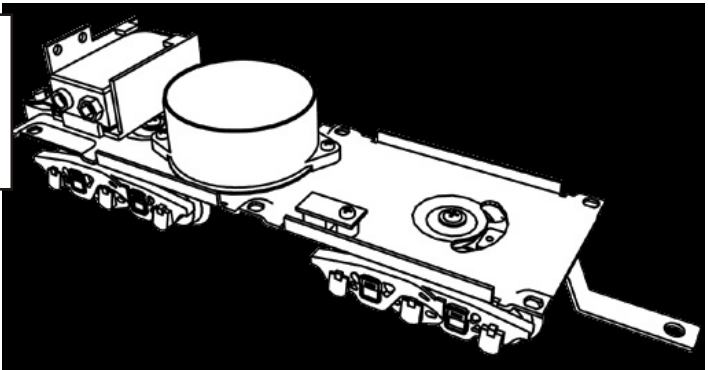
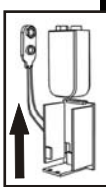



# Quick-Start Video

The included VHS Quick-Start video demonstrates the start-up and basic operation of this set as well as other information about model railroading. You may find it helpful to view the video before operating this set.

# RailWare Interactive CD ROM

M.T.H. provides a free RailWare CD ROM in each Ready-To-Run set. It is full of helpful information on M.T.H. product history, track planning software, a dealer finder, and information and video clips on Loco-Sound and Proto-Sound 2.0. Follow the directions below to use the CD ROM.

Minimum System Requirements: Pentium 100, 16MB RAM, Windows 95 or later, CD ROM drive, Sound Card, display properties set to greater than 256 colors. The CD will not work on a Mac OS unless you run VirtualPC®.

# Running RR-Track Software

You may run the RR-Track software directly off of the CD ROM or you may install the software to your hard drive.

1. On the Desktop, click on the icon that says My Computer.
2. Find your CD ROM drive.
3. With the M.T.H. CD ROM in the drive, double click on the icon for the CD ROM drive.
4. Find the folder on the CD ROM entitled INSTALLATION.
5. Choose the folder inside entitled RRTRAXSETUP.
6. Run the file in that folder called SETUP.EXE and follow the directions it provides.

The program may ask you for a registration code. If it does type in "M.T.H." and it will run.

Additional track libraries can be obtained directly from RR-Track. See their website for more information [www.rtrack.com](http://www.rtrack.com).

# Installing Adobe Acrobat Software

To read some of the electronic documents included on the CD ROM, you will need to install the Adobe Acrobat Reader® if it is not already on your computer. To install the software:

1. On the Desktop, click on the icon that says My Computer.
2. Find your CD ROM drive.
3. With the MTH CD ROM in the drive, double click on the icon for the CD ROM drive.
4. Find the folder on the CD ROM entitled INSTALLATION.
5. Choose the folder inside entitled ACROBAT READER.

\*If you are running Windows 95, 98 or NT choose the folder 32 BIT. Run the file AR32E301.EXE and follow the directions it provides.

If you have problems you cannot resolve by using these directions, contact [custserv@mth-railking.com](mailto:custserv@mth-railking.com) or call 410-381-2580 for further help.

# Troubleshooting Proto-Sound® 2.0 Problems

Although Proto-Sound 2.0 has been designed and engineered for ease of use, you may have some questions during initial operation. The following table should answer most questions. If your problem cannot be resolved with this table, contact M.T.H. for assistance (e-mail: [service@mth-railking.com](mailto:service@mth-railking.com); telephone: 410-381-2580; fax: 410-423-0009; mail: 7020 Columbia Gateway Drive, Columbia MD 21046-1532).

<b>Starting Up</b>	<b>Remedy</b>
When I first turn the power on, the engine will not begin to run.	This is normal behavior. To prevent accidental high-speed start-ups, Proto-Sound 2.0 is programmed to start up in neutral anytime track power has been turned off for several seconds. See the "Basic Operation" section for more details.
The engine will not start after I press the Direction button.	You may not be sending enough power to the track to power the engine. Press the throttle up for a few more seconds to increase track power.
My engine sounds are distorted and garbled.	The battery may have run down, especially if the engine has been in storage for some time. See the "Self-Charging Battery Back-Up" section of these instructions for how to test, recharge, and (if necessary) replace the battery.
<b>Whistle</b>	<b>Remedy</b>
I can't get the whistle to blow when I press the whistle button.	You may be pressing the button too quickly. Try pressing the Whistle button more slowly, taking approximately one full second to fully depress the button.
<b>Bell</b>	<b>Remedy</b>
I can't get the bell to ring when I press the bell button.	You may be pressing the button too quickly. Try pressing the bell button more slowly, taking approximately one full second to fully depress the button.
<b>Coupler</b>	<b>Remedy</b>
When I try to fire the coupler, FYS starts.	You are waiting too long between whistle button presses. See the timing instructions located at the beginning of the "Proto-Sound 2.0 Operating Instructions" section.
The Proto-Coupler won't let the engine uncouple on the fly.	Try lubricating the coupler knuckle and rivet with a dry graphite lubricant.
The coupler does not fire or stay coupled.	The coupler needs to be cleaned. Wipe with denatured alcohol (not rubbing alcohol) and let dry.
<b>Cab Chatter</b>	<b>Remedy</b>
Sometimes the Cab Chatter sounds don't play.	Cab Chatter plays only in neutral at random intervals.
<b>Lock-out</b>	<b>Remedy</b>
I can't get the engine to run after I power up the transformer. It sits still with the diesel and compressor sounds running. The engine won't lock into forward, neutral, or reverse.	The engine maybe locked into the neutral position. Follow the procedure in the "Lock into a Direction" section to unlock the engine's direction. Engine speed must be below 10 scale mph (approx. 10 volts or less in conventional mode).

<b>Volume</b>	<b>Remedy</b>
The sounds seem distorted, especially when the whistle or bell is activated.	Proto-Sound 2.0 volume is set too high. Turn the volume control knob on the bottom of the chassis counter-clockwise to reduce the volume.
No Sound	Volume is set too low, adjust volume control knob on the bottom of the chassis clockwise to increase the volume or check connector to speaker.
<b>Battery</b>	<b>Remedy</b>
The engine will not leave the initial neutral setting.	Check to be sure the battery is installed and fully charged. See the "Self-Charging Battery Back-Up" section.
I get no sounds when the engine shifts between directions.	The battery may be dead or need to be charged. See the "Self-Charging Battery Back-Up" section.
After I turn off my transformer, my engine continues to make sounds before quitting.	Proto-Sound 2.0 is designed to continue to sound for a few seconds after power to the track has been shut off to allow for a more realistic shut-down.
<b>FYS</b>	<b>Remedy</b>
The FYS sounds occasionally repeat themselves.	Proto-Sound 2.0 has a built-in random number generator that randomly selects each sound clip to play. Because there are a limited number of sound clips available in each FYS sequence, it is probable that some of these sound clips will be repeated from time to time.
Once in FYS, the engine doesn't go into reverse.	So that FYS effects can be as realistic as possible, Proto-Sound 2.0 disables the reversing unit whenever FYS is enabled. This way the engine remains still at its stop as the operator cycles through the FYS sequences.
When the FYS enters its last sequence the bell automatically comes on.	FYS is programmed to start ringing the bell and then to put the engine in motion at that point. After approximately 15 rings of the bell, it will automatically turn off.
When FYS is enabled, pressing the whistle and bell buttons has no effect.	Because FYS must control various effects in each sequence, Proto-Sound 2.0 takes control of these sound effects until you exit FYS.
I push the Direction button but the next sound clip in the sequence does not play or the engine does not come out of FYS after the fourth press of the Direction button.	Each FYS clip must play for a certain amount of time before FYS will advance to the next step in the FYS cycle. Wait at least 30 seconds in each FYS sound clip before pressing the Direction button.

# Compatibility

While this Ready-To-Run set is equipped with everything you need to operate it, the design allows flexibility. The train will operate on any traditional O-31 or larger O Gauge track system, including the ScaleTrax™ included with this set or traditional tubular track. It is also compatible with most standard AC transformers, including the hobby transformer packaged with your set.

## Transformer Compatibility and Wiring Chart

Note that many of the operational commands described in these instructions require a bell button, so if you are using a transformer other than the one included in this set and your transformer does not have its own bell button, you should consider adding one to get the full benefit of the system.

Transformer Model	Center Rail	Outside Rail	Min/Max. Voltage	Power Rating	Transformer Type
MTH Z-500	Red Terminal	Black Terminal	0-18v	50-Watt	Electronic
MTH Z-750	Red Terminal	Black Terminal	0-21v	75-Watt	Electronic
MTH Z-4000	Red Terminal	Black Terminal	0-22v	390-Watt	Electronic
Lionel 1032	U	A	5-16v	90-Watt	Standard
Lionel 1032M	U	A	5-16v	90-Watt	Standard
Lionel 1033	U	A	5-16v	90-Watt	Standard
Lionel 1043	U	A	5-16v	90-Watt	Standard
Lionel 1043M	U	A	5-16v	90-Watt	Standard
Lionel 1044	U	A	5-16v	90-Watt	Standard
Lionel 1053	U	A	8-17v	60-Watt	Standard
Lionel 1063	U	A	8-17v	60-Watt	Standard
All-Trol	Left Terminal	Right Terminal	0-24v	300-Watt	Electronic
Dallee Hostler	Left Terminal	Right Terminal			Electronic
Lionel LW	A	U	8-18v	75-Watt	Standard
Lionel KW	A or B	U	6-20v	190-Watt	Standard
Lionel MW	Outside Track Terminal	Inside Track Terminal	5-16v	50V.A.	Electronic
Lionel RS-1	Red Terminal	Black Terminal	0-18v	50V.A.	Electronic
Lionel RW	U	A	9-19v	110-Watt	Standard
Lionel SW	U	A	Unknown	130-Watt	Standard
Lionel TW	U	A	8-18v	175-Watt	Standard
Lionel ZW	A,B,C or D	U	8-20v	275-Watt	Standard
Lionel Post-War Celebration Series ZW	A,B,C or D	Common	0-20v	135/190 Watt	Electronic

# Additional Features Accessible with the DCS Remote Control System: (additional equipment required)

While conventional mode operation of a Proto-Sound 2.0 engine yields wonderfully realistic sound and several train control features, command mode operation allows the user to access a world of command functions never before accessible to O Gauge railroaders. With the addition of the DCS Remote Control System (including a DCS remote handheld and Track Interface Unit) users gain many advanced features, including:

- DCS Proto-Speed Control - Establishes desired locomotive speed in scale miles per hour increments via a thumbwheel control and allows operator to set maximum speed and acceleration/deceleration rates
- ProtoSmoke<sup>®</sup> Variable Output Control - Controls how much smoke each engine outputs and matches smoke to locomotive speed
- Locomotive Lighting Control - Controls locomotive headlights, marker and interior lights, beacon lights, ditch lights, and MARS lights
- Emergency Stop-Single button push stops all Proto-Sound 2.0 trains but does not turn off the power
- One Touch Global Mute/UnMute-Single button mutes or unmutes all DCS-controlled locomotives' user-defined actions, including sound, lights, and smoke
- Proto-Dispatch Operation-Public Address-like feature allows users to speak through locomotive speaker during operation
- Proto-Cast-Allows users to play audio recordings through locomotive speaker during operation
- Proto-Doppler Sound Effects Set Up-Users can configure locomotive for Doppler Operation, including setting distance points for Doppler start, repeat, and stop modes
- Independent Volume Control of Engine Sounds, Bell, Horn & Whistle for each Locomotive
- Control up to 50 different DCS-Equipped Locomotives at one time with multiple TIUs
- Proto-Effects<sup>™</sup> Set Up-User can select individual Proto-Effects<sup>™</sup> operations to be active or inactive, including cab chatter, train wreck sounds, coupler sounds, and wheel clickety-clack sounds
- Direction Control Set Up-User can set initial individual start-up direction (start in forward or reverse) for double-heading operations
- Locomotive Consist Set-up-User can determine locomotive values for consist make-ups, allowing multiple locomotives belonging to a consist to operate together
- Query Locomotive Information-User can query locomotive programming to learn locomotive address and engine data information, including scale miles traveled
- User Can Query, Set and Operate Track and Accessory Interface Units for Programming Digital Command Operations for up to 250 Accessories and 250 Individual Switches
- User Can Script, Record and Playback Train Routes

Operating instructions for all DCS Command features will accompany the DCS remote control equipment.

## 2-8-0 Steam Locomotive Engine Parts

Name and Number	Part #
1.) Stanchion ( black ) ( plastic )( 3.0mm long )	FB-1200242
2.) Handrail ( nickel )( boiler )	FB-1200099
3.) Sand dome ( black )	FB-1200246
4.) Bell ( nickel )	FB-1200101
5.) Steam dome ( black )	FB-1200247
6.) Screw ( 4/40x6.0mm )( roundhead )	IA-0000003
7.) Shell ( black ) ( Union Pacific )( # 1757 )	FB-1200238
8.) Lens ( green )( marker )	FA-1230025
9.) Lens ( clear )( headlight )	FA-1230022
10.) Number board ( black ) ( Union Pacific )( # 1757 )	FB-1200250
11.) Smoke unit ( 7.0x8.0x2.0x3.7mm brass cup )( 7.5mm long posts ) ( Proto-Sound 2.0® & Loco Sound™ )	AA-0000029
12.) Insulator washer ( white ) ( 3.0x6.0x3.0mm )	ID-0000025
13.) Voltage regulator ( LM2937ET )	AG-0000032
14.) Insulator ( clear ) ( 13.0x16.0x0.1mm )( single hole )	ID-0000024
15.) Bulb ( clear )( headlight ) ( 6V )( small globe )( screw base )	CA-0000038
16.) Bracket ( black ) ( smoke unit / headlight )	IH-0000085
17.) Crosshead ( nickel ) ( 38.8mm long )	EC-1250016
18.) Drive rod ( nickel )	EC-1250015
19.) Bolt ( nickel ) ( M3x9.5mm long )( hex head 5.0mm ) ( 4.0x2.5mm shoulder )	IA-0000253
20.) Side rod ( nickel ) ( 116.0mm long )( 4 holes )	EC-1250017
21.) Traction tires	DE-0000023
22.) Insulator ( black ) ( top )( square )( pick-up )	BD-0000026
23.) Screw ( nickel ) ( M3x6.0mm )( roundhead )	IA-0000015
24.) Screw ( 6/32x12.0mm )( roundhead )	IA-0000103
25.) Screw ( M3x4.0mm )( roundhead )	IA-0000010
26.) Boards ( Proto-Sound 2.0® )	AE-0000001
27.) Bracket ( Aluminum ) ( for Proto-Sound 2.0® boards ) ( 16.2x32.9mm )( side mounting )	IH-0000210

28.) Switch ( small )	BB-0000009
29.) Screw ( M2x4.0mm )( roundhead )	IA-0000058
30.) Screw ( yellow Zink ) ( M2.5x6.0mm )( roundhead w/ lock washer )	IA-0000089
31.) Motor mount ( black )	BI-0000034
32.) Screw ( 6/32x8.0mm )( roundhead )	IA-0000050
33.) Tach board ( no spacer between board and optical sensor )	AG-0000033
34.) Motor ( RS-365SH ) ( 8.0x21.0mm gear shaft )( 13.0mm gear threads ) ( 9.0x30.0mm white flywheel w/ black stripes ) ( tach board mounting strap )	BE-0000076
35.) Screw ( 6/32x6.0mm )( roundhead )	IA-0000027
36.) Bracket ( black ) ( metal )( 18.6x32.4x40.5mm )( T shaped )	IH-0000211
37.) PC board ( green ) ( w/ 10 pin female plug )	AG-0000039
38.) Wire nut ( yellow )	BI-4500003
39.) Draw bar ( black ) ( 67.5mm long )	FB-1200079
40.) Spring ( 6.5x10.0mm )( w/ 0.6mm thick wire )	IE-0000061
41.) Screw ( 4/40x6.0mm )( washer head )	IA-0000028
42.) Nut ( nickel )( 2.5x5.0x10.0mm )	IC-0000005
43.) Insulator ( black ) ( pick-up )( bottom )( flat )( square )	BD-0000024
44.) Pick-up ( 8.0x11.0mm roller )( 24.0mm long )	BD-0000050
45.) Bolt ( nickel )( M3x9.5mm long ) ( 4.0x2.5mm shoulder )( 5.0mm hex head )	IA-0000253
46.) E-clip ( 2.5x6.0x0.5mm )	IF-0000004
47.) Truck ( lead )( single axle )	DA-1230013
48.) Washer ( 3.0x7.0x0.4mm )	ID-0000028
49.) Spring ( 6.5x11.0mm )( w/ 0.4mm thick wire )	IE-0000007
50.) Pin ( 3.0x9.0mm )( flathead )( 1 e-clip groove )	IG-0000007
51.) Pivot plate ( nickel ) ( for lead truck )	IH-0000021
52.) Drive block ( black )( 4 axle )	DF-1200037
NS.) Wire harness ( 12 pin black male plug )	BC-1200098
NS.) Wire harness ( 7 pin black male plug )	BC-1200099
NS.) Wire harness ( 5 pin black male plug )	BC-1200100
NS.) Wire harness ( 4 pin black male plug )	BC-1200101

# 2-8-0 Steam Locomotive Engine Parts

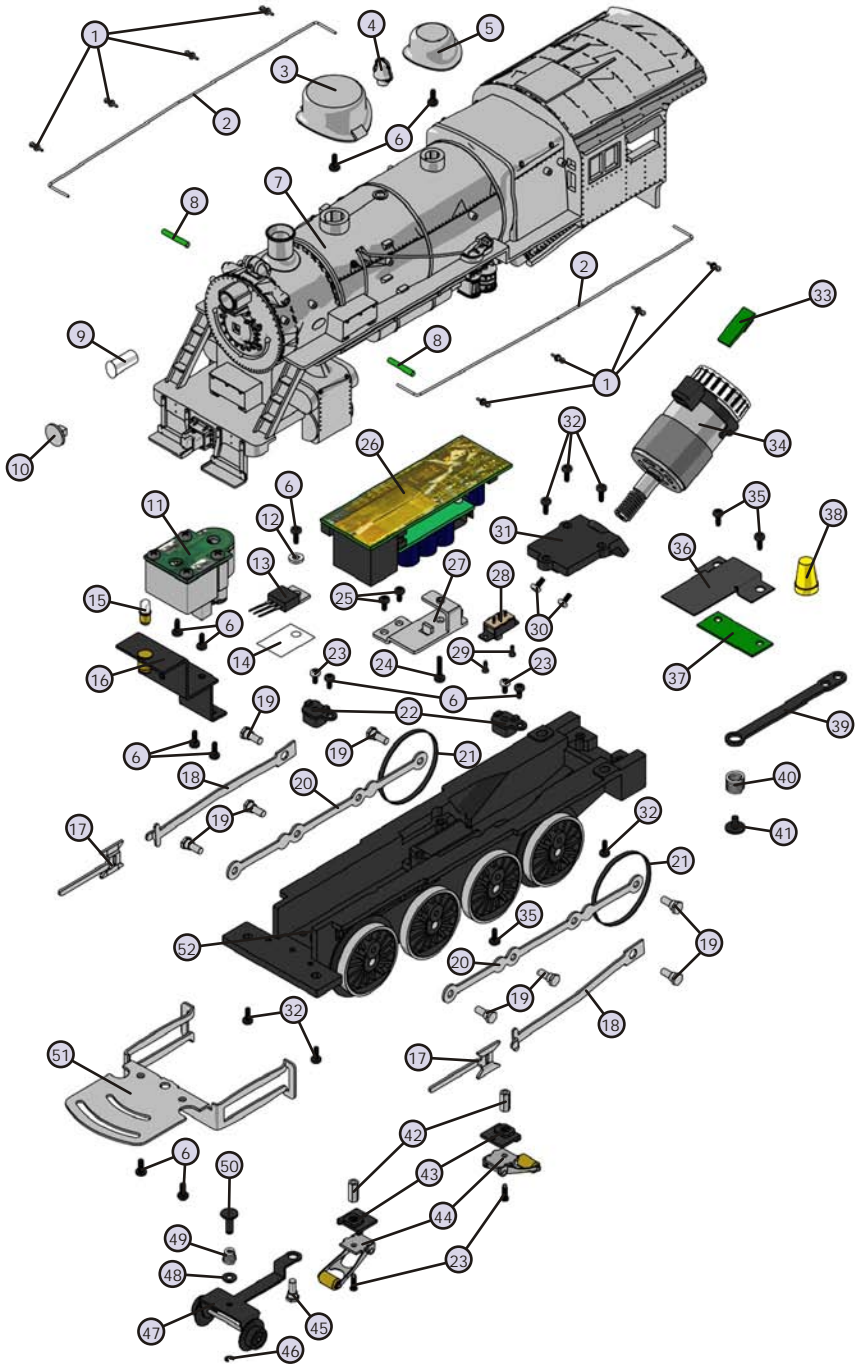



## 2-8-0 Steam Engine Tender Parts

Name and Number	Part #
1.) Shell ( black )( tender )( plastic ) ( Union Pacific )( # 1757 )	GA-1200095
2.) Screw ( M3x8.0mm )( roundhead )	IA-0000035
3.) Speaker cone ( black ) ( 44.0x48.3x37.0mm )( plastic )( 2 screw hole tabs )	BF-0000020
4.) Speaker ( STAR )( PR-050-A111 )( 16 ohms )( MAX 2W )	BF-0000007
5.) Gasket ( black ) ( speaker ring )( 43.8x49.8x3.0mm )( foam )	IB-0000009
6.) Wire harness ( black ) ( 10 pin male plug )( w/ 295.0mm long wires ) ( black, white & blue 2 pin female plugs ) ( battery jack & small volume pot )	BC-1200102
7.) Battery jack ( black )	BG-0000001
8.) Screw ( M2x4.0mm )( roundhead )	IA-0000058
9.) Spacer ( black ) ( 3.0x6.0x4.3mm )( plastic )	ID-0000071
10.) Volume pot ( small ) ( blue pot mounted on green PC board )	BI-0000040
11.) Battery leads ( 60.0mm long wires w/ blue 2 pin male plug )	BC-0000094
12.) Screw ( M3x4.0mm )( roundhead )	IA-0000010
13.) Battery	BG-4000001
14.) Bracket ( black ) ( battery )( horizontal side mount )( plastic )	IH-0000116
15.) Chassis ( black ) ( 58.0x175.0mm )( has new hole for battery jack )	GB-1200047
16.) T-bar ( black )( plastic )	IG-0000001
17.) Proto-Coupler 2.0® ( 51.0mm long )	DD-0000032
18.) Spring ( nickel ) ( 6.5x14.0mm )( 0.5mm thick wire )	IE-0000022
19.) E-clip ( 3.0x8.0x0.5mm )	IF-0000002
20.) Screw ( M3x16.0mm )( washer head )( self-drilling threads )	IA-0000025
21.) Screw ( 6/32x6.0mm )( washer head )	IA-0000214
22.) Truck ( black )( tender )( 2 axle )	DA-1250012
23.) Screw ( 4/40x6.0mm )( roundhead )	IA-0000003
24.) Washer ( 4.5x10.0x0.6mm )	ID-0000041

# 2-8-0 Steam Engine Tender Parts

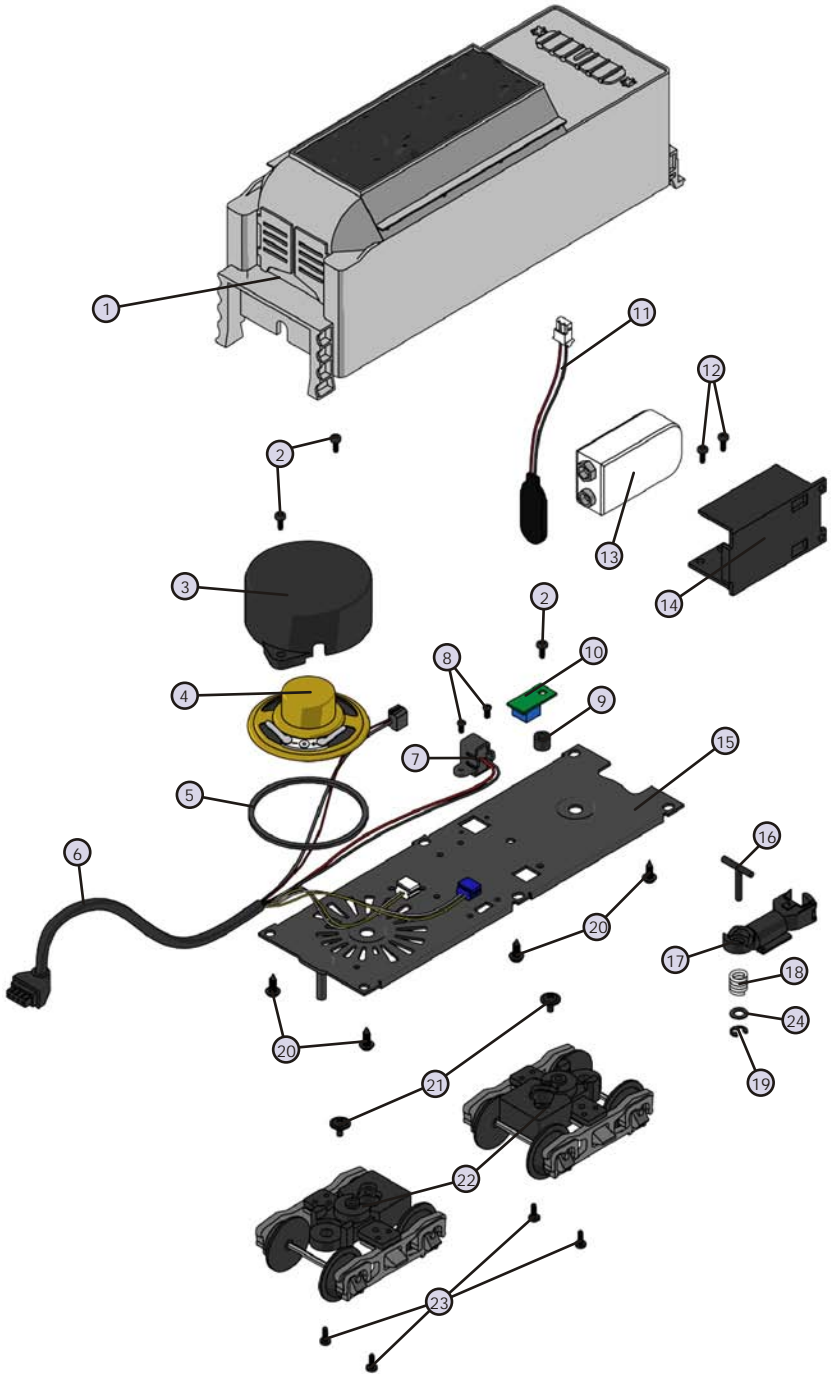

# Service & Warranty Information

## How to Get Service Under the Terms of the Limited One-Year Warranty

For warranty repair, follow the instructions below to obtain warranty service.

First, e-mail, write, call or fax an Authorized M.T.H. Service Center in your area or M.T.H. Electric Trains to obtain Repair Authorization. You can find the list of Authorized Service Centers on the M.T.H. website, [www.mth-railking.com](http://www.mth-railking.com). Authorized Service Centers are required only to make warranty repairs on items sold from that store; all other repairs may or may not be done at the store's own discretion. Otherwise, contact M.T.H. (fill out the Service Contact form in the Service Section of [www.mth-railking.com](http://www.mth-railking.com); send US mail to the address listed below; tel: 410-381-2580; fax: 410-423-0009), stating when the item was purchased and describing the problem. If you contact M.T.H., you will be given a return authorization number to assure that your merchandise will be properly handled upon its receipt.

**CAUTION:** Make sure the product is packed in its original factory packaging including its foam and plastic wrapping material so as to prevent damage to the merchandise. The shipment must be prepaid and we recommend that it be insured. *A cover letter including your name, address, daytime phone number, e-mail address (if available), Return Authorization number, a copy of your sales receipt and a full description of the problem must be included to facilitate the repairs. Please include the description regardless of whether you discussed the problem with a service technician when contacting the Service Center or M.T.H. for your Return Authorization.*

Please make sure you have followed the instructions carefully before returning any merchandise for service.

## Limited One-Year Warranty

All M.T.H. products purchased from an Authorized M.T.H. Train Merchant are covered by this warranty.

See our website at [www.mth-railking.com](http://www.mth-railking.com) or call 1-888-640-3700 to identify an Authorized M.T.H. Train Merchant near you.

M.T.H. products are warrantied for one year from the date of purchase against defects in material or workmanship, excluding wear items such as light bulbs, pick-up rollers, batteries, smoke unit wicks, and traction tires. We will repair or replace (at our option) the defective part without charge for the parts or labor, if the item is returned to an Authorized M.T.H. Service Center or M.T.H. Electric Trains within one year of the original date of purchase. This warranty does not cover damages caused by improper care, handling, or use. Transportation costs incurred by the customer are not covered under this warranty.

Items sent for repair must be accompanied by a return authorization number, a description of the problem, and a **copy of the original sales receipt from an Authorized M.T.H. Train Merchant**, which gives the date of purchase. If you are sending the item to M.T.H., fill out the Service Contact form in the Service Section of [www.mth-railking.com](http://www.mth-railking.com); send US mail to the address listed below; call 410-381-2580, or fax 410-423-0009 to obtain a return authorization number. If you are sending this product to an Authorized Service Center, contact that Center for their return authorization.

This warranty gives you specific legal rights, and you may have other rights that vary from state to state.

Service Department



## AUTHORIZED SERVICE CENTER

7020 Columbia Gateway Dr. - Columbia, MD 21046

Information: 410-381-2580 Fax: 410-381-6122

[www.mth-railking.com](http://www.mth-railking.com)

## PARTICIPATING N.A.S.C. RETAILER LIST

### CANADA

TOY TRAIN WORKSHOP  
CUMBERLAND  
613-833-8331

THE TRAIN ROOM  
FERGUS  
519-787-3280

### CALIFORNIA

TIN PLATE JUNCTION  
OAKLAND  
510-444-4780

### COLORADO

MIZELL TRAINS INC  
WESTMINSTER  
303-429-4811

### CONNECTICUT

NEW ENGLAND HOBBY  
SUPPLY  
MANCHESTER  
860-646-0610

### FLORIDA

ROUNDHOUSE SOUTH  
PORT ORANGE  
386-304-7002

### MARYLAND

PLAZA HOBBY  
CUMBERLAND  
301-729-6424

ENGINE HOUSE HOBBIES  
GAITHERSBURG  
301-590-0816

CATOCTIN MOUNTAIN TRAINS  
& HOBBIES  
THURMONT  
301-694-8331

### MICHIGAN

MICHIGAN MODEL TRAIN  
CENTER  
PINCKNEY  
734-426-1651

BRASSEUR ELECTRIC TRAINS  
INC.  
SAGINAW  
989-793-4753

### NEW HAMPSHIRE

TREASURED TOYS  
SALEM  
603-898-7224

### NEW YORK

AURORA RAILS & HOBBIES  
EAST AURORA  
716-652-5718

### OHIO

DAVIS ELECTRONICS  
MILFORD  
513-831-6425

RICK'S TOY TRAINS  
TOLEDO  
419-478-0171

### PENNSYLVANIA

BUSSINGER TRAINS  
AMBLER  
215-628-2366

FAIRCHANCE PHARMACY  
FAIRCHANCE  
724-564-7817

TOBY TYLER'S HOBBY  
CENTER  
PITTSBURGH  
412-653-5030

### VIRGINIA

LOCUST GROVE TRAINS  
LOCUST GROVE  
540-854-8955

DAVIS HOBBY SUPPLIES  
PORTSMOUTH  
757-397-1983

T S G HOBBIES  
WARRENTON  
540-347-9212

### WISCONSIN

SOMMERFELD'S TRAINS  
BUTLER  
262-783-7797

GRAMPA'S TRAIN SHOP  
RICE LAKE  
715-234-2996



# AUTHORIZED SERVICE CENTER

7020 Columbia Gateway Dr. - Columbia, MD 21046

Information: 410-381-2580 Fax: 410-381-6122

[www.mth-railking.com](http://www.mth-railking.com)

## PARTICIPATING A.S.C. RETAILER LIST

### CANADA

TOY TRAIN WORKSHOP  
CUMBERLAND  
613-833-8331

THE TRAIN ROOM  
ERGUS  
519-787-3280

CREDIT VALLEY RAILWAY  
COMPANY  
STREETSVILLE  
905-826-1306

B H TRAINS  
TERREBONNE  
450-492-0317

ALABAMA  
SOUTHERLAND STATION  
HUNTSVILLE  
256-533-4720

LIL' BOBBY'S HOBBIES  
MONTGOMERY  
334-277-1715

ARIZONA  
ARIZONA TRAIN DEPOT  
MESA  
480-833-9486

CALIFORNIA  
CENTRAL COAST TRAINS  
ATASCADERO  
805-466-1391

TRAIN SHACK  
BURBANK  
818-842-3330

ROUNDHOUSE  
NORTH HOLLYWOOD  
818-769-0403

DOLLHOUSES TRAINS & MORE  
NOVATO  
415-883-0388

TIN PLATE JUNCTION  
OAKLAND  
510-444-4780

RON'S WORLD  
SAN CLEMENTE  
949-361-5596

TRUCKS & TRAINS HOBBIES  
SANTA ROSA  
707-537-6586

COLORADO  
CUSTOM RAILWAY SUPPLY  
COLORADO SPRINGS  
719-634-4616

CABOOSE HOBBIES  
DENVER  
303-777-6766

MIZELL TRAINS  
WESTMINSTER  
303-429-4811

CONNECTICUT  
NEW ENGLAND HOBBY  
SUPPLY  
MANCHESTER  
860-646-0610

FLORIDA  
HOLLYWOOD STATION  
HOLLYWOOD  
954-921-2700

DEPOT HOBBY SHOP  
LAKE WORTH  
561-585-1982

READY TO ROLL  
MIAMI  
305-688-8868

FRANK'S TRAINS & HOBBIES  
OLDSMAR  
813-855-1041

COLONIAL PHOTO & HOBBY  
ORLANDO  
407-841-1485

WARRICK CUSTOM HOBBIES  
PLANTATION  
954-370-0708

ROUNDHOUSE SOUTH  
PORT ORANGE  
386-304-7002

ILLINOIS  
BIKE & CHOO CHOO  
CONNECTION  
SCHAUMBURG  
847-882-7728

INDIANA  
Y. O. R. K. TRAINS  
MUNSTER  
219-838-9999

SAMUELSON'S TRAIN SHOP  
VALPARAISO  
219-462-2708

IOWA  
CABOOSE STOP HOBBIES  
CEDAR FALLS  
800-642-7012

KENTUCKY  
L&N TRAINS & THINGS  
LOUISVILLE  
502-897-9005

LOUISIANA  
AMERICA'S TRAIN YARD  
BATON ROUGE  
225-926-5592

**MAINE**

WHEELS, WINGS & THINGS  
LUDLOW  
207-532-6277

**MARYLAND**

PLAZA HOBBY  
CUMBERLAND  
301-729-6424

HOBBYTOWN U S A  
FREDERICK  
301-694-7395

ENGINE HOUSE HOBBIES  
GAITHERSBURG  
301-590-0816

J & B TRAINS  
HAGERSTOWN  
240-420-4930

THE TRAIN ROOM  
HAGERSTOWN  
301-745-6681

PURKEY'S TOY TRAINS  
SYKESVILLE  
410-549-6061

CATOCTIN MOUNTAIN TRAINS  
& HOBBIES  
THURMONT  
301-694-8331

**MASSACHUSETTS**

NORTHEAST TRAINS  
PEABODY  
978-532-1615

EAST BAY HOBBIES  
SEEKONK  
508-336-5573

**MICHIGAN**

MICHIGAN MODEL TRAIN  
CENTER  
PINCKNEY  
734-426-1651

BRASSEUR ELECTRIC TRAINS  
INC.  
SAGINAW  
989-793-4753

**MISSOURI**

SWITCH STAND  
SAINT LOUIS  
314-781-4458

MARK TWAIN HOBBYCENTER  
ST. LOUIS  
636-946-2816

**NEVADA**

RENO RAILS  
RENO  
775-337-6669

**NEW HAMPSHIRE**

RAILROAD SPECIALTIES  
NASHUA  
603-801-0801

**TREASURED TOYS**

SALEM  
603-898-7224

**NEW JERSEY**

COUNTRY AND STUFF  
ANDOVER  
973-786-7086

**COLUMBUS TRAIN STATION**

COLUMBUS  
609-518-1800

**ATLANTIC RAILS**

HAMMONTON  
609-567-8490

**GRAND CENTRAL STATION**

KEARNY  
201-955-6200

**J & B TRAINS, INC.**

MAPLE SHADE  
856-414-0092

**HOBBY SHOP**

MATAWAN  
732-583-0505

**HOBBYMASTERS, INC**

RED BANK  
732-842-6020

**RIDGEFIELD HOBBY**

RIDGEFIELD  
201-943-2636

**TOM'S MODEL TRAINS**

SCOTCH PLAINS  
908-322-6122

**TRAINS & THINGS**

TRENTON  
609-883-8790

**COAST TRAINS AND**

COLLECTIBLES  
WALL  
732-556-9005

**HOLLY BEACH TRAIN DEPOT**

WILDWOOD  
609-522-2379

**NEW YORK**

AURORA RAILS & HOBBIES  
EAST AURORA  
716-652-5718

**NASSAU HOBBY CENTER, INC.**

FREEPORT  
516-378-9594

**HOBBY WORLD**

MONTICELLO  
845-794-8770

**CITY DEPOT, INC.**

NEW HAMPTON  
845-374-3010

**SCAG'S ELECTRIC TRAINS**

STATEN ISLAND  
718-727-7373

**AMERICANA STORE**

TIVOLI  
845-757-4246

**KROSS HARDWARE**

WEST BABYLON  
631-669-3069

**NORTH CAROLINA**

THE ROUNDHOUSE &  
BACKSHOP  
CARY  
919-465-0810

**TRAINS LTD.**

CHARLOTTE  
704-566-9070

**DRY BRIDGE STATION**

MOUNT AIRY  
336-786-9811

**THE FREIGHT YARD**

SMITHFIELD  
919-934-6229

**TRAIN LOFT**

WINSTON-SALEM  
336-760-9817

**OHIO****GLEN'S TRAIN SHOP**

AKRON  
330-253-6527

**E & S TRAINS**

AKRON  
330-745-0785

**T & K HOBBY SHOP**

BRIDGEPORT  
740-633-6607

**PARMAHOBBY**

CLEVELAND  
216-741-6440

**SANDY'S HOBBY'S &**

COLLECTIBLES

ELYRIA  
440-365-9999

**HUDSON TOY, TRAIN &**

HOBBY

HUDSON  
330-653-2997

**CLEARVIEW TRAIN & HOBBY**

LORAIN  
440-277-4488

**DIXIE UNION STATION**

MASON  
513-459-0460

**DAVIS ELECTRONICS**

MILFORD  
513-831-6425

TRAINS-N- THINGS  
NORTH CANTON  
330-499-1666

GRAND PACIFIC JUNCTION  
OLMSTEAD FALLS  
440-235-4777

RICK'S TOY TRAINS  
TOLEDO  
419-478-0171

ERIE RAILWAY DEPOT  
TROY  
937-440-9972

**PENNSYLVANIA**  
AMERICAN HOBBY CENTER  
ALIQUIPPA  
724-378-3930

ALLENTOWN TOY TRAIN  
SERVICE  
ALLENTOWN  
610-821-0740

ON THE RIGHT TRACK  
ALTOONA  
814-942-4345

BUSSINGER TRAINS  
AMBLER  
215-628-2366

JIM'S HOBBY SERVICE  
BERWICK  
570-759-2695

YE OLDE TRAIN & CHRISTMAS  
SHOPPE  
BOYERTOWN  
610-369-0755

NICHOLAS SMITH  
BROOMALL  
610-353-8585

CHARLEROI SWEEPER  
CENTER  
CHARLEROI  
724-483-3397

CRANBERRY HOBBY DEPOT  
CRANBERRY TWP  
724-776-3640

FAIRCHANCE PHARMACY  
FAIRCHANCE  
724-564-7817

TOY TRAIN STATION  
FEASTERVILLE TREV  
215-322-5182

THE CABOOSE  
LEHIGHTON  
570-386-5352

HOBBY CITY  
MC MURRAY  
724-942-2557

THE STATION  
NEW CUMBERLAND  
717-774-7096

FRYER'S STORE  
ORWIGSBURG  
570-366-2258

CHESTNUT TOYBOX  
PHILADELPHIA  
215-545-0455

TOBY TYLER'S HOBBY  
CENTER  
PITTSBURGH  
412-653-5030

WILCOX GREENHOUSE &  
NURSERY  
TITUSVILLE  
814-827-3823

EASTERN DEPOT  
TROY  
570-297-1975

J&J RAILROAD CROSSING  
TURTLE CREEK  
412-824-6009

TRAINS R FUN  
LEESBURG  
703-779-8600

**SOUTH CAROLINA**  
EMERALD TRAIN & HOBBY  
GREENWOOD  
864-223-2247

**TENNESSEE**  
MODEL RAILROAD & HOBBY  
SHOP  
MEMPHIS  
901-384-6500

**TEXAS**  
HOBBY TIME  
AMARILLO  
806.352.9660

RIVERVIEW TRAINS  
ANGLETON  
979-848-3895

GREAT TRAINS & HOBBIES  
LONGVIEW  
903-757-2720

**VIRGINIA**  
LEESBURG HOBBIES  
LEESBURG  
703-779-8600

LOCUST GROVE TRAINS  
LOCUST GROVE  
540-854-8955

TRAIN DEPOT  
MANASSAS  
703-335-2216

CHESTERFIELD HOBBIES  
MIDLOTHIAN  
804-379-9091

DAVIS HOBBY SUPPLIES  
PORTSMOUTH  
757-397-1983

TOY TRAIN CENTER  
RICHMOND  
804-288-4475

NUTBUSH EXPRESS  
VICTORIA  
434-696-1902

T S G HOBBIES  
WARRENTON  
540-347-9212

NORGE STATION  
WILLIAMSBURG  
757-564-7623

**WASHINGTON**  
EASTSIDE TRAINS  
KIRKLAND  
425-828-4098

**WEST VIRGINIA**  
PATRICK'S TRAINS  
WHEELING  
304-232-0714

**WISCONSIN**  
WOODCRAFTERS SHOP  
BURLINGTON  
262-763-5239

SOMMERFELD'S TRAINS  
BUTLER  
262-783-7797

HOBBY OUTLET  
FOND DU LAC  
920-924-3770

G B T V & TRAINS  
GREEN BAY  
920-496-9697

GRAMPA'S TRAIN SHOP  
RICE LAKE  
715-234-2996

THE TRAIN STORE  
WAUKESHA  
262-650-6675