

RAILKING
READY-TO-RUN™
sets
THE COMPLETE SOLUTION

www.railking.com

6-8-6 Bantam Turbine Steam Passenger Set

Operation Manual



DLS
PROTO-SOUND
DIGITAL COMMAND SYSTEM



RAILKING
By MICHIGAN TRAINS

Thank you for purchasing this RailKing product.
PLEASE READ BEFORE USE AND SAVE

Table of Contents

Set Up Checklist	3
Getting Started	4
Assembling Real Trax	4
Installing the Lock-on	4
Connecting the Transformer	4
Lubricating the Engine	5
Priming the Smoke Unit	5
Coupling the Engine and Cars	5
Remote Control	6
Checking the Battery	6
Basic Operation	7
Operation Buttons	7
Manual Volume Control	7
Proto-Sound 2.0 Operation	8
Activating Proto-Sound 2.0 Conventional Mode Features	8
Passenger Station Announcements (PSA)	8
Tip on Using PSA	9
Proto-Coupler® Operation	9
Speed Control	10
Lock into a Direction	10
Reset to Factory Defaults	11
Automatic Sounds	11
Maintenance	12
Care of Remote Control	12
Lubrication and Greasing Instructions	12
Cleaning the Wheels, Tires and Track	13
Locomotive Traction Tire Replacement	13
Smoke Unit Maintenance	13
Locomotive Light Bulb Replacement	14
Passenger Car Light Bulb Replacement	15
Self-Charging Battery Back-Up	16
RailWare Interactive CDROM	17
Troubleshooting	18
Compatibility	20
Transformer Compatibility Chart	20
Additional Features with DCS Remote Control System	21
Exploded View Parts	22
Service and Warranty Information	

CAUTION: ELECTRICALLY OPERATED PRODUCT:

Not recommended for children under 10 years of age. M.T.H. recommends adult supervision with children ages 10-16. As with all electric products, precautions should be observed during handling and use to reduce the risk of electric shock.

WARNING: When using electrical products, basic safety precautions should be observed, including the following:

Read this manual thoroughly before using this device.

- M.T.H. recommends that all users and persons supervising use examine the hobby transformer and other electronic equipment periodically for conditions that may result in the risk of fire, electric shock, or injury to persons, such as damage to the primary cord, plug blades, housing, output jacks or other parts. In these conditions exist, the train set should not be used until properly repaired.
- Do not operate your layout unattended. Obstructed accessories or stalled trains may overheat, resulting in damage to your layout.
- This train set is intended for indoor use. Do not use if water is present. Serious injury or fatality may result.
- Do not operate the hobby transformer with damaged cord, plug, switches, buttons or case.
- The transformer was designed to operate on regular US household current (120 volt, 50-60 Hertz). Do not connect to any other source of power.
- To avoid the risk of electrical shock, do not disassemble the transformer unit. There are no user-serviceable parts inside. If the unit is damaged contact M.T.H. Service for instructions.
- The transformer is equipped with an internal circuit protector. If the circuit protector trips, unplug the power cord from the electrical wall outlet, check your layout for any short circuits. The circuit breaker will reset automatically when the shorts are removed from the circuit.
- Unplug the transformer from the electrical wall outlet when not in use.
- Do not use this transformer for other than its intended purpose.

Transformer Ratings:

Input: 120 VAC, 60 Hz Only, Output: 21 VAC, 3.75A 78VA

Set Up Checklist

- Assemble RealTrax®
- Connect the transformer
- Lubricate the engine
- Prime the Smoke Unit
- Place the engine and cars on the track and couple them together
- Check to see whether the battery needs to be charged for full sound effects
- Apply power or run as described in the Basic Operation section of these instructions.

Set Includes



Steam Engine with Loco-Sound™



Steam Tender



8-Pieces
O-31 Curve RealTrax



Track Clips



3 Passenger Cars



Remote Control



Lock-On



CD-Rom



Video

Tools Needed

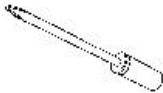

Phillips Screwdriver



Pliers



Scissors



Cotton Swab or Rag



Rail King Maintenance Kit or
Light Household Oil and Bearing Grease

Optional Equipment



Microphone w/ 1/8" Plug



1/8" Male to Male Plug



Cassette Player

You can obtain replacement parts and replacement instructions from the **M.T.H. Parts Department**

e-mail: parts@nth-railking.com

phone: 410-381-2580

mail: 7020 Columbia Gateway Drive, Columbia MD 21046-1532

Getting Started

Assembling RealTrax®

The quick connectors and built-in road bed allow you to setup RealTrax anywhere, including carpeted surfaces.

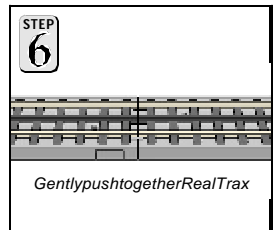
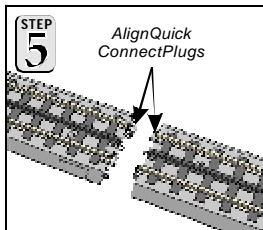
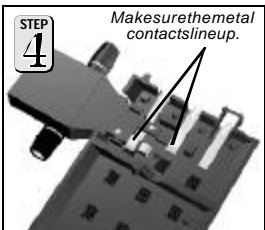
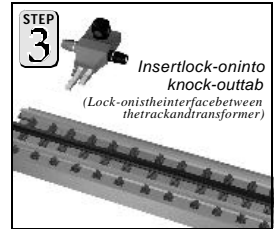
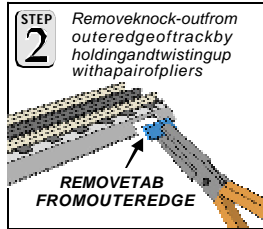
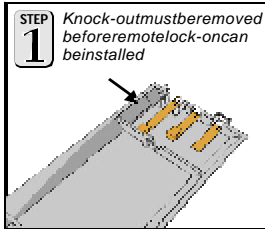

Connecting TrackClips

If you prefer not to screw your track to the table for a permanent layout, use the enclosed track clips on adjoining curved RealTrax sections to secure them in place.

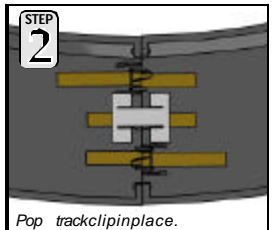
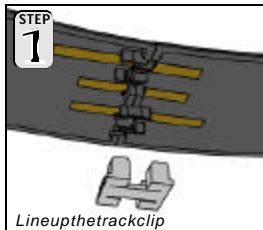

Connecting the Transformer

The 75-watt power supply included with this set provides an easy-to-use, safe power source for AC-powered trains and accessories.

- Plug the wire from the transformer into the remote lock-on's center port, then plug the transformer into the wall outlet.
- Unplug when not in use.

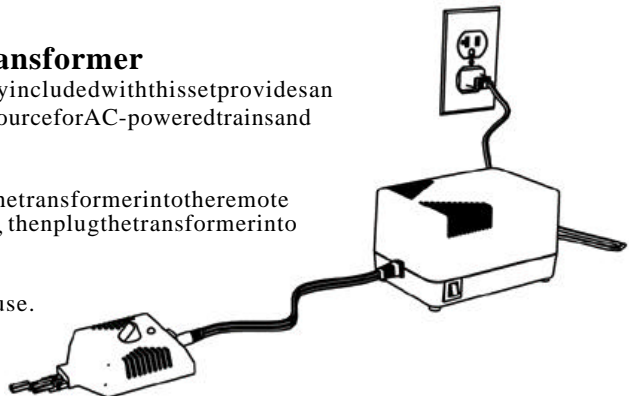

Lubricating the Engine

Lubricate all exposed moving parts before operating using a multi-purpose, plastic-compatible oil (available with M.T.H.'s Maintenance Kit, sold separately) or a light household oil. Follow the lubrication points.

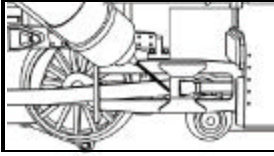

Lubricate Valve Gear

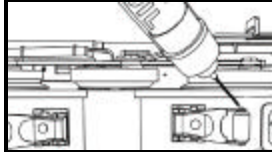

Lubricate Pick-Up Rollers
(Do Not Oil the Flat Part of Pick-Up Rollers)

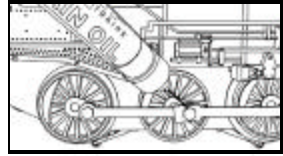

Lubricate Side Rods

Priming the Smoke Unit

You should prime the smoke unit with smoke fluid before operating. Add 15-20 drops of smoke fluid from the included pipette through the smoke stack, then gently blow into the stack to eliminate any air bubbles in the fluid.

If you choose not to prime the unit with fluid, turn the smoke unit switch located under the engine to the OFF position. **Running the engine without a primed smoke unit may cause damage.** See the "Proto Smoke Unit Operation" section of this book for more information on smoke unit maintenance.

Add 15-20 Drops
Smoke Fluid

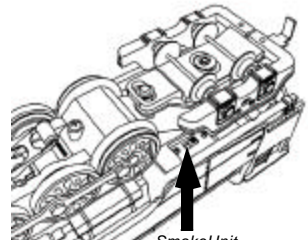
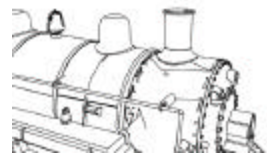

Smoke Unit
ON/OFF switch



Running the engine without a primed smoke unit may cause damage

Coupling the Engine and Cars

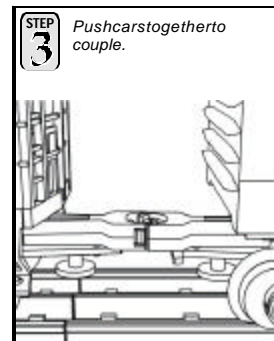
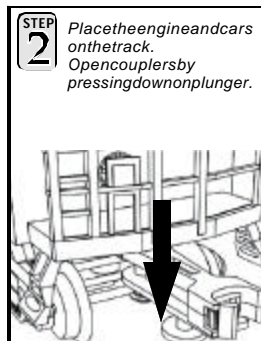
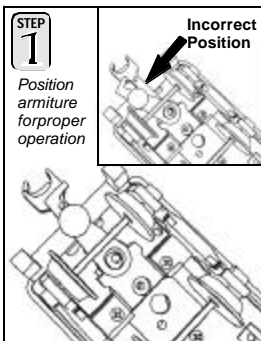

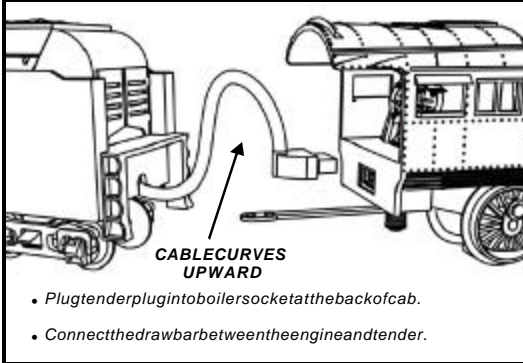

! DONOTCONNECT This Engine To A Tender From Another Engine; It May Cause Serious Damage.

Look at the bottom of the engine and tender where each will have a color-coded stamp. If they match you may connect those two pieces; if not, don't.

Checking the Battery

You may find, if your set was built several months before you set it up, that the rechargeable battery has run down and needs to be charged before operating. If you notice that the sounds are garbled, test and charge the engine as described in the "Self-Charging Battery Back-Up" on page 16.

Remote Control

The remote and lock-on are designed for use with moderate power supplies such as the one included with this set. It is compatible with virtually any manufacturer's engines.

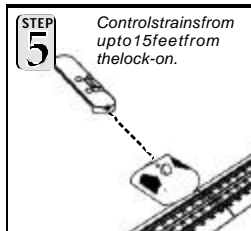
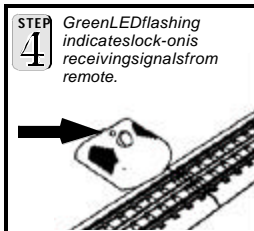
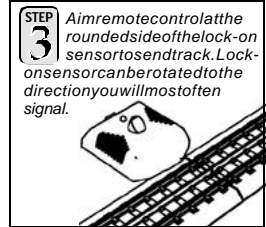
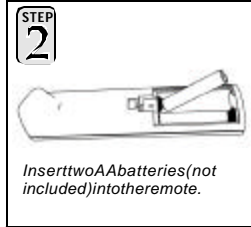
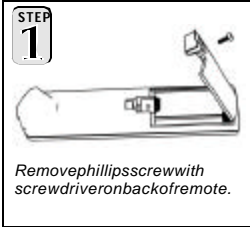

Note: The RailKing® Remote Control and Remote Lock-on will not operate engines equipped with pre-1997 versions of Proto-Sound® or with Proto-One,™ Proto-Plus,™ Proto-Deluxe,™ aftermarket systems.

Basic Operation

Operation Buttons

Throttle Up Throttle up the power to your track by pressing the top end of the Throttle Control Rocker Switch firmly for about 5 seconds, until the engine's headlight and lighted cars burn bright. Then put the engine in motion by firmly pressing the Direction button (hold it for approximately 1 second) on your remote once. If the engine does not begin to move as soon as you firmly press the Direction button, you may not have sent enough voltage to the track to make the train move. Press the throttle up for a few more seconds until the train begins to move. To increase or decrease track voltage, and therefore train speed, press the throttle control rocker switch. Pressing the top end of the throttle will increase voltage and speed. Pressing the bottom end of the throttle will decrease voltage and speed. The engine will maintain this speedy you set after you release the throttle until you press it again to change the voltage and speed.

Bell - To sound the bell, firmly press and release the Bell button. To turn the bell off, press and release the Bell button again. The bell will continue to ring from the time you turn it on until you press and release the button again to turn it off.

Emergency Stop Press the Emergency Stop button and all trains on the track controlled by the remote will stop until you reapply voltage. This is an easy way to shut down your trains at the end of a session or to stop suddenly if the train's path becomes obstructed.

CAUTION: *Do not mix old and new batteries. Do not mix alkaline, standard (carbon-zinc), or rechargeable (nickel-cadmium) batteries.*

Manual Volume Control

To adjust the volume of all sounds made by this engine, turn the master volume control knob located under the tender clockwise to increase the volume and counter-clockwise to decrease the volume.

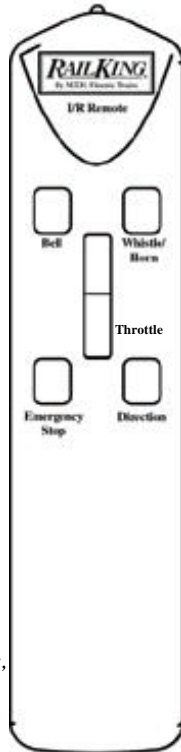

Horn/Whistle - To sound the whistle, firmly press the Horn/Whistle button. The whistle will sound for as long as you continue to depress the button. It will stop when you release the button.

Direction Your train is programmed to start in neutral. The train will always cycle neutral-forward-neutral-reverse with each press and release of the direction button. The engine is programmed to restart in neutral each time the track voltage is turned off for 25 seconds or more.

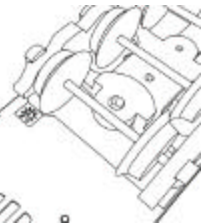
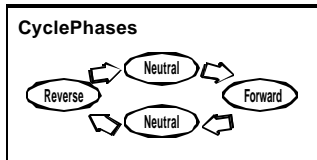

Proto-Sound 2.0 Operating Instructions

This manual contains the operating instructions for Proto-Sound 2.0 in conventional mode only. Instructions for accessing DC S command mode features accompany the DC S Remote Control System equipment.

Activating Proto-Sound 2.0 Conventional Mode Features:

Proto-Sound 2.0 features are activated by sequences of Bell and Whistle button pushes described below. Please read the full descriptions of each feature before using it. To use these buttons to activate features rather than to blow the whistle or ring the bell, you should tap the buttons very quickly with a 1/2-second pause between button presses. You may need to practice your timing to make this work smoothly.

Timing Chart				
Press Whistle Short & Firm	1/2 Sec. Pause	Press Bell Short & Firm	1/2 Sec. Pause	Press Bell Short & Firm
Total Time Lapse: 1 1/2 Seconds				

Feature to Be Activated	Button Code:
Passenger Station Announcements	1 Bell, 2 Whistles
Fire the Rear Coupler	1 Bell, 3 Whistles
Fire the Front Coupler	1 Bell, 4 Whistles
Speed Control On/Off	1 Whistle, 2 Bells (from Neutral only)
Lock into a Direction	1 Whistle, 3 Bells
Reset to Factory Defaults	1 Whistle, 5 Bells (from Neutral only)

Passenger station announcements (PSA):

Your engine is equipped with a sound package of passenger station announcements that you can play when you pull into a station. Each sequence described below will play as long as it is left on, randomly generating sounds, but be sure to allow approximately 30 seconds between the button pushes described below to allow the PSA sufficient time to run through each sequence.

- To cue the sound system to play the PSA, quickly but firmly tap the Bell button once followed by 2 quick taps of the Whistle button while the engine is moving. Tap the buttons quickly but allow approximately 1/2 second between each press.
- Press the Direction button once to stop the engine. This will trigger the first sequence of PSA. Thereverse unit is temporarily disabled so that the train will not move as you use the Direction button to trigger the sounds, and Proto-Sound 2.0 has disabled operator control over the Whistle and Bell buttons until the full PSA sequence is complete.
- After waiting about 30 seconds for that sequence to run, press the Direction button again to trigger the second sequence of PSA.
- After about 30 seconds, press the Direction button again to trigger the third PSA sequence.

- Again, after allowing about 30 seconds for that sequence to run, press the Direction button one more time to trigger the fourth and final PSA sequence. The PSA will continue, and within a few seconds, the engine and bell will start and move out of its own at the current throttle setting, in the same direction it was traveling when you began the sequence. Once the bell turns off, the operator regains control of the transformer's bell and Whistle buttons and can ring the bell or blow the Whistle as usual.

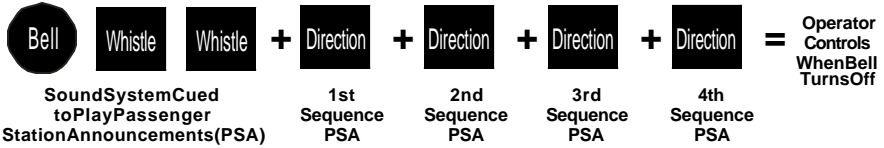

Tipson Using PSA

- You can terminate PSA at any time by turning off power to the track for 15 seconds.
- You do not have to be in Forward to use PSA. At the conclusion of the full sequence, the train will pull away from the station in whatever direction you were going when you activated the feature.
- You can use PSA even if you are double-heading with another engine. If the second engine is not equipped with Proto-Sound 2.0, you must remember not to leave the throttle at a high voltage level once you have stopped the engine to run the PSA. Otherwise, the engine without PSA will begin vibrating on the track as its motors strain to move the train, since they cannot be automatically disabled during the PSA cycle (or if an original Proto-Sound engine, PSA are triggered differently and that engine's motor-disable feature will not be active when you run PSA in Proto-Sound 2.0).
- PSA can be triggered from Neutral. It will operate the same as if triggered while in motion except that, at the conclusion of the PSA, the engine will depart in the next direction of travel, as opposed to the direction it was traveling before entering Neutral.

Proto-Coupler® Operation

This locomotive is equipped with one or more coil-wound Proto-Couplers for remote uncoupling action. Because Proto-Couplers are controlled through the Proto-Sound 2.0 microprocessor, they do not require an uncoupling track section or modification to your layout to function. You can fire a coupler from neutral or while in motion. Use the code shown below (and in the chart on p. 8) to fire the coupler(s).

Rear Coupler:

To fire the rear coupler, quickly tap the Bell button once followed by three quick taps of the Whistle button, allowing approximately 1/2 second to lapse between each quick button press. The sound of the lift bar and air line depletion will play, and the knuckle will be released.



Front Coupler:

To fire the front coupler (if your engine has one), quickly tap the Bell button once followed by four quick taps of the Whistle button, allowing approximately 1/2 second to lapse between each quick button press. The sound of the lift bar and air line depletion will play, and the knuckle will be released.



Speed Control:

M.T.H. engines equipped with Proto-Sound 2.0 have speed control capabilities that allow the engine to maintain a constant speed up and down grades and around curves, much like an automobile cruise control. You can add or drop cars on the run, and the engine will maintain the speedy you set.

While the engine is programmed to start with the speed control feature activated, you can opt to turn it off. This means the engine's speed will fall as it labors up a hill and increase as it travels downward. It is also affected by the addition or releasing of cars while on the run. Because the engine will run more slowly at a given throttle voltage when speed control is on than when it is off, you should adjust the throttle to a lower power level for operation with speed control off to avoid high-speed derailments. When speed control is off, the volume will drop to allow for better low voltage operation.

To turn speed control on and off, put the engine in neutral, then quickly tap the transformer's Whistle button one time then quickly tap the Bell button two times, allowing approximately 1/2 second to lapse between each quick button press. Two horn blasts will indicate that the engine has made the change. Repeat the 1 whistle, 2 bells code to return to the other condition. You will want to do this during the initial neutral upon start-up if you ever couple this engine to another engine that is not equipped with speed control to avoid damaging the motors in either engine. Each time you shut down the engine completely, it will automatically turn speed control on.



Lock into a Direction:

You can lock your engine into a direction (forward, neutral, or reverse) so that it will not change directions. To do this, put the engine into the direction you want (or into neutral to lock it into neutral), run it at a very slow crawl (as slowly as it will move without halting), and quickly but firmly tap the Whistle button once followed by three quick taps of the Bell button, allowing approximately 1/2 second to lapse between each quick button press. Two whistle blasts will indicate that the engine has made the change. The engine will not change direction (including going into neutral) until you repeat the 1 whistle, 3 bells code to return the engine to its normal condition, even if the engine is kept without power for extended periods of time.



Reset to Factory Defaults:

To override the settings you currently have assigned to the engine and reset it to its factory defaults, while in Neutral tap the Whistle button quickly once, followed by five quick taps of the Bell button, allowing approximately 1/2 second to lapse between each quick button press. Two whistle blasts will indicate that the engine has made the change.

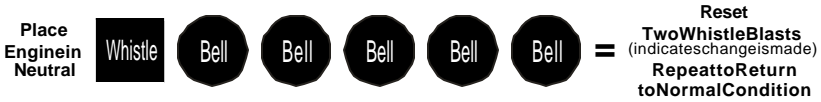

Automatic Sounds:

Certain Proto-Sound 2.0 sound effects automatically play in programmed conventional mode conditions:

- **Squealing Brakes** play any time the engine's speed decreases rapidly.
- **Cab Chatter** plays at random intervals when the engine idles in neutral.
- **Engine Start-up and Shut-down** sounds play when the engine is initially powered on or is powered off for five seconds or more.

Maintenance

Care of the Remote Control

Your Rail King Remote Control System should offer years of trouble-free service. There are a few things you can do to ensure trouble-free operation:

- If your train responds inconsistently, replace old batteries with fresh ones. Do not mix old and new batteries.
- Remove batteries before storing for extended periods.
- Do not drop the remote. It can damage the delicate electronics inside.
- Any attempt by anyone other than an authorized M.T.H. repair person to open and repair the handheld transmitter or lock-on may result in damage and the loss of warranty protection.

Lubrication Instructions

The engines should be oiled and greased in order to run properly.

Regularly lubricate all side rods and linkage components and pick-up rollers to prevent squeaking. Use light household oil, such as that found in M.T.H.'s maintenance kit. Do not overoil. Use only a drop or two on each pivot point.

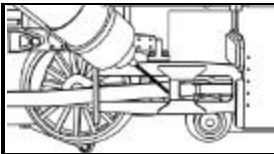

Lubricate Valve Gear

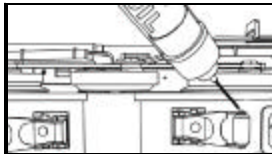

Lubricate Pick-Up Rollers
(Do Not Oil the Flat Part of Pick-Up Rollers)

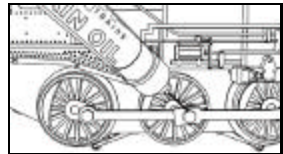

Lubricate Side Rods

Greasing Instructions

The locomotive's internal gearing was greased at the factory. Grease engine every 50 hours of use or one year. Use lithium based grease and follow the greasing instructions.

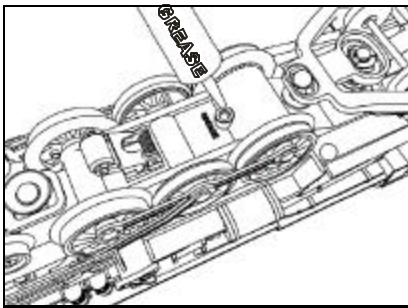

- Remove the screw from the chassis to open the grease port.
- Insert the grease tube tip into the port and squeeze the tube once or twice to add grease to the gearbox.
- Wipe off any excess grease and replace the phillips screw securely.

Cleaning the Wheels, Tires and Track

Periodically check the locomotive wheels and pickups for dirt and buildup, which can cause poor electrical contact and traction and prematurely wear out the neoprene traction tires. Wheels and tires can be cleaned using denatured (not rubbing) alcohol applied with a cotton swab.

To clean the track, use Rail King Track Cleaning Fluid and a clean rag or denatured (not rubbing) alcohol. Unplug the transformer and wipe the rails of the track, turning the rag frequently to ensure that you are using clean cloth on the rails. Because the manufacturing process leaves a coating on Real Trax center rail, you should clean the rails after the first 30 minutes of use (you may notice an electrical smell during initial use as the coating wears off; this is normal). Thereafter, keep an eye on the track and clean it when it gets dirty to ensure good electrical contact and to lengthen the life of the tires.



Traction Tire Replacement Instructions

Your locomotive is equipped with two neoprene rubber traction tires on the rear set of flanged drivers. While these tires are extremely durable, you may need to replace them at some point.

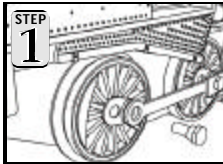

- Remove the siderods (the rod that connects each drive wheel to the other) from the wheels in order to slip the new tire over the grooved drive wheel. These bolts can be loosened with a 5mm nut driver.
- Clean the groove using a cotton swab and denatured alcohol.

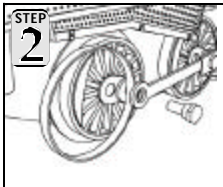

- Make sure the old tire has been completely removed from the groove in the drive wheel, using a razor blade or small flathead screwdriver to pry away any remains.
- Clean the groove using a cotton swab and denatured alcohol.
- Slip the new tire onto the wheel. You may find it useful to use two small flathead screwdrivers to stretch the tire over the wheel.
- If you wish the tire while stretching it over the wheel, you will need to remove and reinstall the tire. Otherwise your engine will wobble while operating.
- Make sure the tire is fully seated inside the groove. Use a razor blade to trim away any excess tire that doesn't seat itself inside the groove properly.

ProtoSmoke® Unit Operation

This steam locomotive contains a smoke unit that outputs smoke through the smoke stack on the boiler of the engine. The smoke unit is essentially a small heating element and wick that soaks up and then heats a mineral oil-based fluid that emits a harmless smoke. The smoke is then forced out of the stack by a small electric fan.

With a few easy maintenance steps, you should enjoy trouble-free smoke unit operation for years.

- When preparing to run this engine, add 15-20 drops of smoke fluid through the smoke stack. We recommend M.T.H. ProtoSmoke, Seuth, LGB, or LVT fluids (a small pipette of ProtoSmoke fluid is included). Do not overfill the unit or the fluid may leak out and coat the interior engine components.

- If you choose not to add the fluid (or have already added the fluid but choose to run smoke-free), turn off the smoke units switch located under the engine body. **Failure either to add fluid to the unit or to turn it off may damage the smoke unit heating element and/or wicking material.**

Add 15-20 Drops
Smoke Fluid

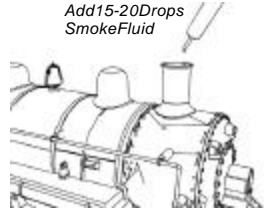

Running the engine without a primed smoke unit may cause damage

- When the smoke output while running the engine begins to diminish, add another 10-15 drops of smoke fluid or turn the smoke unit off.
- When storing the unit for long periods of time, you may want to add about 15 drops of fluid to prevent the wick from drying out.
- After removing the engine from storage, add another 25 drops of fluid, letting the wick soak up the fluid for 15 minutes prior to operation.

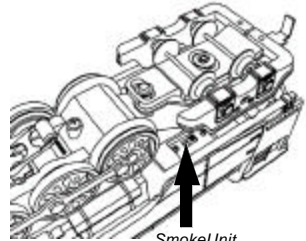

Smoke Unit
ON/OFF Switch

If you experience poor or no smoke output when the smoke unit is on and has fluid, check the wick to see if it has become hard, blackened, and unabsorbent around the heating element. Remove the boilers shown below. Remove the smoke unit inspection cover from the locomotive's body (see right). After removing the chassis and inspection covers screws, lift the inspection plate away and inspect the wick. If it is darkly discolored and hard, it should be replaced. When priming new wick add 40 drops.



Smoke Unit Cover



Wick in
Poor
Condition



Wick in
Good
Condition

Locomotive Light Bulb Replacement

To replace the light bulb in the locomotive, follow the boiler removal instructions below.

STEP
1

Remove the four Phillips screws from the chassis then lift the body away from the chassis.

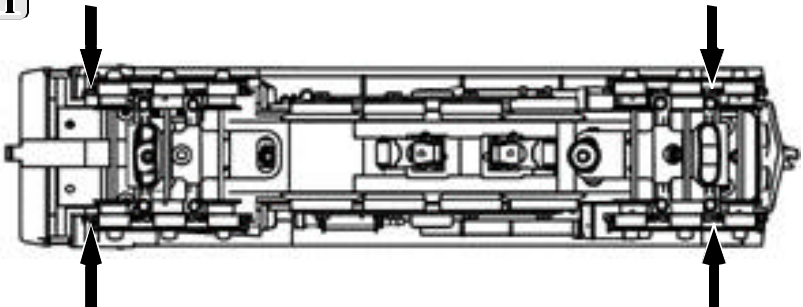

STEP
2

Once the locomotive boiler has been removed from its chassis, locate the bulb bracket as seen in the illustration on the right and rotate the headlight bulb counter-clockwise to remove.

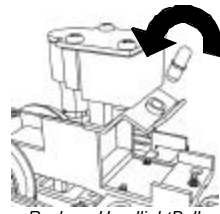

Passenger Car Light Bulb Replacement

To replace the interior light bulbs follow these instructions and see the diagrams

You can obtain replacement bulbs directly from the M. T. H. Parts Department.

STEP
1

Turn the car over and remove the two mounting screws holding the roof on.

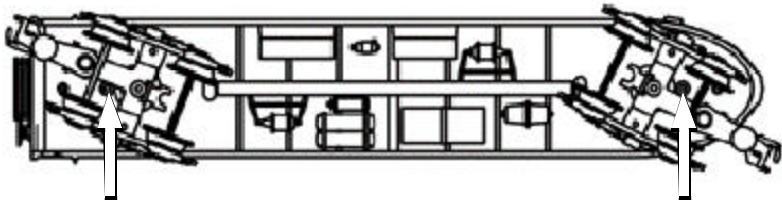

STEP
2

Turn the car back over and gently twist the ends of the car in opposite directions until the roof pops off. Lift the car roof away from the body and chassis.

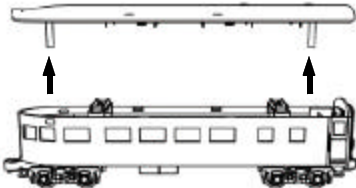

STEP
3

Gently pull the bulb away from its housing and push the replacement bulb into the housing.

Reassemble in reverse order.

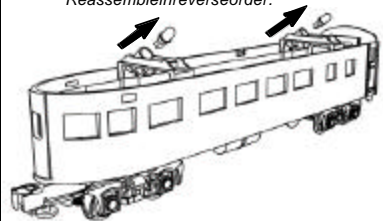

Self-Charging Battery Back-Up

This special NiCad 7-cell 8.4v self-charging battery recharges continuously during train operation and should last for up to five years. The battery is a dry battery that should not leak or cause any damage to your engine. **Depending upon when your engine was built, it may need to be charged right out of the box.** If engine sounds seem distorted or garbled at low voltages or becomes silent when power from the transformer is turned off, test the battery to determine whether it should be recharged or replaced.

- **Test:** Put the engine in neutral and leave the track voltage at 10-12 volts (high enough for the light to shine brightly and the engine to move steadily) for 15 minutes.
- **Recharge:** If the sounds are improved at the end of the 15-minute test charge, the battery charge has run down and can be recharged. There are a number of ways you can do this:
 - Leave the engine in neutral with track voltage at 10-12 volts for 6-7 hours so the battery can fully recharge (if your engine has a smoke unit, be sure it is turned off).
 - Use M.T.H.'s battery recharger (sold separately) that plugs into a wall outlet and a special port under the tender to recharge the battery overnight without leaving it on the track.



- **Replace:** If the sounds are not improved at the end of the 15-minute test charge, it is time to replace the battery. Available through M.T.H. Parts. A standard 9v alkaline battery can be substituted until your replacement arrives, but since alkaline batteries cannot be recharged, it will eventually wear down. **Do NOT use a 6-cell 7.2v battery.**

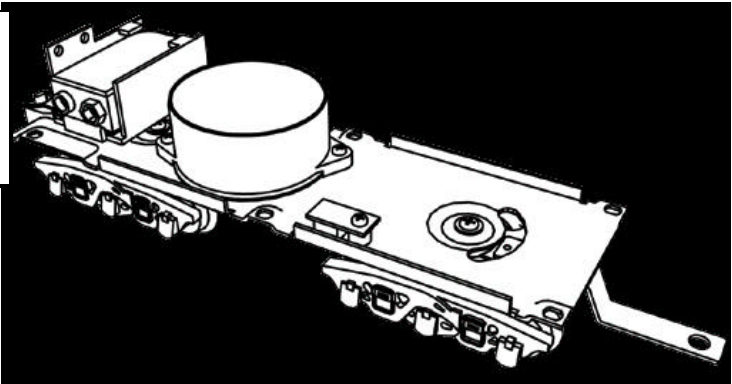
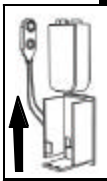

Quick-Start Video

The included VHS Quick-Start video demonstrates the start-up and basic operation of this set as well as other information about model railroading. You may find it helpful to view the video before operating this set.

RailWare Interactive CD ROM

M.T.H. provides a free RailWare CD ROM in each Ready-To-Run set. It is full of helpful information on M.T.H. product history, track planning software, a dealer finder, and information and video clips on Loco-Sound and Proto-Sound 2.0. Follow the directions below to use the CD ROM.

Minimum System Requirements: Pentium 100, 16MB RAM, Windows 95 or later, CD ROM drive, Sound Card, display properties set to greater than 256 colors. The CD will not work on a Mac OS unless you run a Virtual PC.

Running RR-Track Software

You may run the RR-Track software directly off of the CD ROM or you may install the software to your hard drive.

1. On the Desktop, click on the icon that says My Computer.
2. Find your CD ROM drive.
3. With the M.T.H. CD ROM in the drive, double click on the icon for the CD ROM drive.
4. Find the folder on the CD ROM entitled INSTALLATION.
5. Choose the folder inside entitled RRTRAXSETUP.
6. Run the file in that folder called SETUP.EXE and follow the directions it provides.

The program may ask you for a registration code. If it does type in "M.T.H." and it will run.

Additional track libraries can be obtained directly from RR-Track. See their website for more information www.rtrack.com.

Installing Adobe Acrobat Software

To read some of the electronic documents included on the CD ROM, you will need to install the Adobe Acrobat Reader® if it is not already on your computer. To install the software:

1. On the Desktop, click on the icon that says My Computer.
2. Find your CD ROM drive.
3. With the MTH CD ROM in the drive, double click on the icon for the CD ROM drive.
4. Find the folder on the CD ROM entitled INSTALLATION.
5. Choose the folder inside entitled ACROBATREADER.

*If you are running Windows 95, 98 or NT choose the folder 32BIT. Run the file AR32E301.EXE and follow the directions it provides.

If you have problems you cannot resolve by using these directions, contact custserv@nth-railking.com or call 410-381-2580 for further help.

Troubleshooting Proto-Sound® 2.0 Problems

Although Proto-Sound 2.0 has been designed and engineered for ease of use, you may have some questions during initial operation. The following table should answer most questions. If your problem cannot be resolved with this table, contact M.T.H. for assistance (e-mail: service@mth-railking.com; telephone: 410-381-2580; fax: 410-423-0009; mail: 7020 Columbia Gateway Drive, Columbia MD 21046-1532).

Starting Up	Remedy
When I first turn the power on, the engine will not begin to run.	This is normal behavior. To prevent accidental high-speed start-ups, Proto-Sound 2.0 is programmed to start up in neutral any time track power has been turned off for several seconds. See the "Basic Operation" section for more details.
The engine will not start after I press the Direction button.	You may not be sending enough power to the track to power the engine. Press the throttle up for a few more seconds to increase track power.
My engine sounds are distorted and garbled.	The battery may have run down, especially if the engine has been in storage for some time. See the "Self-Charging Battery Back-Up" section of these instructions for how to test, recharge, and (if necessary) replace the battery.
Whistle	Remedy
I can't get the whistle to blow when I press the whistle button.	You may be pressing the button too quickly. Try pressing the Whistle button more slowly, taking approximately one full second to fully depress the button.
Bell	Remedy
I can't get the bell to ring when I press the bell button.	You may be pressing the button too quickly. Try pressing the bell button more slowly, taking approximately one full second to fully depress the button.
Coupler	Remedy
When I try to fire the coupler, PS A starts.	You are waiting too long between whistle button presses. See the timing instructions located at the beginning of the "Proto-Sound 2.0 Operating Instructions" section.
The Proto-Coupler won't let the engine uncouple on the fly.	Try lubricating the coupler knuckle and drivet with a dry graphite lubricant.
The coupler does not fire or stay coupled.	The coupler needs to be cleaned. Wipe with denatured alcohol (not rubbing alcohol) and let dry.
Cab Chatter	Remedy
Sometimes the Cab Chatter sounds don't play.	Cab Chatter plays only in neutral at random intervals.
Lock-out	Remedy
I can't get the engine to run after I power up the transformer. It sits still with the diesel and compressor sounds running. The engine won't lock into forward, neutral, or reverse.	The engine may be locked into the neutral position. Follow the procedure in the "Lock into a Direction" section to unlock the engine's direction. Engine speed must be below 10 scale mph (approx. 10 volts or less in conventional mode).

Volume	Remedy
The sounds seem distorted, especially when the whistle or bell is activated.	Proto-Sound 2.0 volume is set too high. Turn the volume control knob on the bottom of the chassis counter-clockwise to reduce the volume.
No Sound	Volume is set too low, adjust volume control knob on the bottom of the chassis clockwise to increase the volume or check connector to speaker.
Battery	Remedy
The engine will not leave the initial neutral setting.	Check to be sure the battery is installed and fully charged. See the "Self-Charging Battery Back-Up" section.
I get no sound when the engine shifts between directions.	The battery may be dead or need to be charged. See the "Self-Charging Battery Back-Up" section.
After I turn off my transformer, my engine continues to make sounds before quitting.	Proto-Sound 2.0 is designed to continue to sound for a few seconds after power to the track has been shut off to allow for a more realistic shut-down.
PSA	Remedy
The PSA sounds occasionally repeat themselves.	Proto-Sound 2.0 has a built-in random number generator that randomly selects each sound clip to play. Because there are a limited number of sound clips available in each PSA sequence, it is probable that some of these sound clips will be repeated from time to time.
Once in PSA, the engine doesn't go into reverse.	So that PSA effects can be as realistic as possible, Proto-Sound 2.0 disables the reversing unit whenever PSA is enabled. This way the engine remains still at its stop as the operator cycles through the PSA sequences.
When the PSA enters its last sequence the bell automatically comes on.	PSA is programmed to start ringing the bell and then to put the engine in motion at that point. After approximately 15 rings of the bell, it will automatically turn off.
When PSA is enabled, pressing the Horn and bell button has no effect.	Because PSA must control various effects in each sequence, Proto-Sound 2.0 takes control of these sound effects until you exit PSA.
If I push the Direction button but the next sound clip in the sequence does not play or the engine does not come out of PSA after the fourth press of the Direction button.	Each PSA clip must play for a certain amount of time before PSA will advance to the next step in the PSA cycle. Wait at least 30 seconds in each PSA sound clip before pressing the Direction button.

Compatibility

While this Ready-To-Run set is equipped with everything you need to operate it, the design allows flexibility. The train will operate on any traditional O-31 or larger O Gauge track system, including the Scale Trax™ included with this set or traditional tubular track. It is also compatible with most standard AC transformers, including the hobby transformer packaged with your set.

Transformer Compatibility and Wiring Chart

Note that many of the operational commands described in these instructions require a bell button, so if you are using a transformer other than the one included in this set and your transformer does not have its own bell button, you should consider adding one to get the full benefit of the system.

Transformer Model	Center Rail	Outside Rail	Min/Max. Voltage	Power Rating	Transformer Type
MTHZ-500	Red Terminal	Black Terminal	0-18v	50-Watt	Electronic
MTHZ-750	Red Terminal	Black Terminal	0-21v	75-Watt	Electronic
MTHZ-4000	Red Terminal	Black Terminal	0-22v	390-Watt	Electronic
Lionel1032	U	A	5-16v	90-Watt	Standard
Lionel1032M	U	A	5-16v	90-Watt	Standard
Lionel1033	U	A	5-16v	90-Watt	Standard
Lionel1043	U	A	5-16v	90-Watt	Standard
Lionel1043M	U	A	5-16v	90-Watt	Standard
Lionel1044	U	A	5-16v	90-Watt	Standard
Lionel1053	U	A	8-17v	60-Watt	Standard
Lionel1063	U	A	8-17v	60-Watt	Standard
All-Trol	Left Terminal	Right Terminal	0-24v	300-Watt	Electronic
Dallee Hostler	Left Terminal	Right Terminal			Electronic
Lionel LW	A	U	8-18v	75-Watt	Standard
Lionel KW	A or B	U	6-20v	190-Watt	Standard
Lionel MW	Outside Track Terminal	Inside Track Terminal	5-16v	50V.A.	Electronic
Lionel RS-1	Red Terminal	Black Terminal	0-18v	50V.A.	Electronic
Lionel RW	U	A	9-19v	110-Watt	Standard
Lionel SW	U	A	Unknown	130-Watt	Standard
Lionel TW	U	A	8-18v	175-Watt	Standard
Lionel ZW	A, B, C or D	U	8-20v	275-Watt	Standard
Lionel Post-War Celebration Series ZW	A, B, C or D	Common	0-20v	135/190 Watt	Electronic

Additional Features Accessible with the DCS Remote Control System: (additional equipment required)

While conventional mode operation of a Proto-Sound 2.0 engine yields wonderfully realistic sound and several train control features, command mode operation allows the user to access a world of command functions never before accessible to O Gauge railroaders. With the addition of the DCS Remote Control System (including a DCS remote handheld and Track Interface Unit) users gain many advanced features, including:

- DCS Proto-Speed Control - Establishes desired locomotive speed in scale miles per hour increments via a thumb wheel control and allows operator to set maximum speed and acceleration/deceleration rates
- ProtoSmoke[®] Variable Output Control - Control show much smoke each engine outputs and matchessmoke to locomotive speed
- Locomotive Lighting Control - Controls locomotive headlights, marker and interior lights, beacon lights, ditch lights, and MARS lights
- Emergency Stop - Single button push stops all Proto-Sound 2.0 trains but does not turn off the power
- One Touch Global Mute/Unmute - Single button mutes or unmutes all DCS-controlled locomotives' user-defined actions, including sound, lights, and smoke
- Proto-Dispatch Operation - Public Address-like feature allows user to speak through locomotive speaker during operation
- Proto-Cast - Allows user to play audio recording through locomotive speaker during operation
- Proto-Doppler Sound Effects Set Up - Users can configure locomotive for Doppler Operation, including setting distance points for Doppler start, repeat, and stop modes
- Independent Volume Control of Engine Sounds, Bell, Horn & Whistle for each Locomotive
- Control up to 50 different DCS-Equipped Locomotives at one time with multiple TIUs
- Proto-Effects[™] Set Up - Users can select individual Proto-Effects[™] operations to be active or inactive, including cab chatter, train wreck sounds, couplers sounds, and wheel clickety-clack sounds
- Direction Control Set Up - Users can set initial individual start-up direction (start in forward or reverse) for double-heading operations
- Locomotive Consist Set-up - Users can determine locomotive values for consist make-ups, allowing multiple locomotives belonging to a consist to operate together
- Query Locomotive Information - Users can query locomotive programming to learn locomotive address and engine data information, including scale mile traveled
- User Can Query, Set and Operate Track and Accessory Interface Units for Programming Digital Command Operations for up to 250 Accessories and 250 Individual Switches
- User Can Script, Record and Playback Train Routes

Operating instructions for all DCS Command features will accompany the DCS remote control equipment.

6-8-6 Bantam Turbine Steam Locomotive

Engine Parts

NameandNumber	Part #
1.) Stanchion (black) (plastic)(3.0mmlong)	FB-1200242
2.) Handrail(nickel) (20.0x207.0mm)(right)	FB-1210040
3.) Handrail(nickel) (20.0x207.0mm)(left)	FB-1220047
4.) Shell(Brunswickgreen,gray) (Pennsylvania)(#6200)(castmetal)	FB-1200185
5.) Markerlens(green) (2.2x13.3mm)(2.8x1.2)(plastic)	FA-1230003
6.) Lens(clear) (headlight)(7.0x6.0x13.0mm)	FA-1230022
7.) Numberplate(Tuscan&gold) (Keystone)(#6200)	FB-1230005
8.) Smokeunit (Proto-Sound®2.0)	AA-0000029
9.) Bulb(clear)(6v) (smallglobe)(screwbase)(headlight)	CA-0000038
10.) Screw (4/40x6.0mm)(roundhead)	IA-0000003
11.) Bracket(black)(metal) (3step)(headlight/smokeunit)	IH-0000172
12.) Tractiontire	DE-0000022
13.) Bolt(M3x8.0mm)(nickel) (5.0mmhexhead)(4.0x2.5mmshoulder)	IA-0000087
14.) Siderod(nickel) (1.0x85.0mm)(4holes)	EC-1250024
15.) Driveblock(black)(4axle)	DF-1200028
16.) Insulator(black)(pick-up) (top)(square)(hasmountingtabontopleft)	BD-0000047
17.) Screw(nickel) (M3x6.0mm)(roundhead)	IA-0000015
18.) Screw (4/40x12.0mm)(roundhead)	IA-0000264
19.) Bracket(Aluminum) (Proto-Sound2.0®)	IH-0000170
20.) Boards(Proto-Sound®2.0)	AE-0000001
21.) Screw (M2x4.0mm)(roundhead)	IA-0000058
22.) Switch(small)	BB-0000009
23.) Screw(yellowZinc) (M2.5x6.0mm)(roundheadw/lockwasher)	IA-0000089

24.) Screw (6/32x10.0mm)(roundhead)	IA-0000040
25.) Motormount(black)	BI-0000034
26.) Screw (6/32x6.0mm)(roundhead)	IA-0000027
27.) PCboard(green) (w/10pinfemaleplug)	AG-0000039
28.) Tachboard	AG-0000033
29.) Motor(RS-365SH) (8.0x21.0mm wormgear)(13.0mm long threads) (9.0x30.0mm whiteflywheelw/blackstripes) (tachboard mounting strap)	BE-0000076
30.) Wirenut(yellow)	BI-4500003
31.) Pin(5.0x25.0mm)(black) (8.0x1.5mm flathead)(2e-clipgrooves)	IG-0000033
32.) Drawbar(black) (10.0x105.0mm)(multiple bendw/tenderhook)	FB-1200183
33.) Washer(5.0x12.0x0.8mm)	ID-0000012
34.) E-clip(3.5x9.0x0.6mm)	IF-0000009
35.) Spring(conical) (6.0x12.5x13.0mm)(0.6mm thick wire)	IE-0000062
36.) Washer(5.0x12.0x0.6mm)	ID-0000053
37.) Truck(black) (trailing)(boiler)(3 axle)	DA-1240033
38.) Spacer(black) (7.0x9.0x4.0mm)(metal)	ID-0000096
39.) Screw (6/32x6.0mm)(washerhead)	IA-0000214
40.) Screw (6/32x8.0mm)(roundhead)	IA-0000050
41.) Nut(nickel)(2.5x5.0x10.0mm)	IC-0000005
42.) Insulator(black) (pick-up)(bottom)(square)	BD-0000001
43.) Pin(black)(3.1x14.8mm) (6.0x1.0mm roundedhead) (1e-clipgroove0.5mm out from end)	IG-0000003
44.) Bracket(black) (37.0mm long)(1.0mm thick)(2 bends)(lead truck)	GA-1200068
45.) Spring(nickel) (6.5x9.0mm)(0.5mm thick wire)	IE-0000009
46.) E-clip(2.5x6.0x0.5mm)	IF-0000004
47.) Insulator washer(white) (6.0x4.0x2.5mm)(plastic)	ID-0000033
48.) Voltaregulator(LM2937ET)	AG-0000032
49.) Insulator(clear) (13.0x19.0x0.1mm)(single hole)	ID-0000024
50.) Truck(black) (boiler)(lead)(3 axle)	DA-1230023

51.) Spacer(black) (3.5x15.0x2.5mm)(metal)(cupped)	ID-0000014
52.) Pick-up (8.0x11.0mmroller)(28.0mmlong)	BD-0000048
53.) Screw (4/40x4.0mm)(roundhead)	IA-0000021
NS.) Wireharness (10pingreenfemalePCboard)	BC-1200019
NS. Wireharness (7pinblackmaleplug)	BC-1200014
NS. Wireharness (5pinblackmaleplug)	BC-1200015
NS.) Wireharness (4pinblackmaleplug)	BC-1200020

6-8-6 Bantam Turbine Steam Locomotive Engine Parts

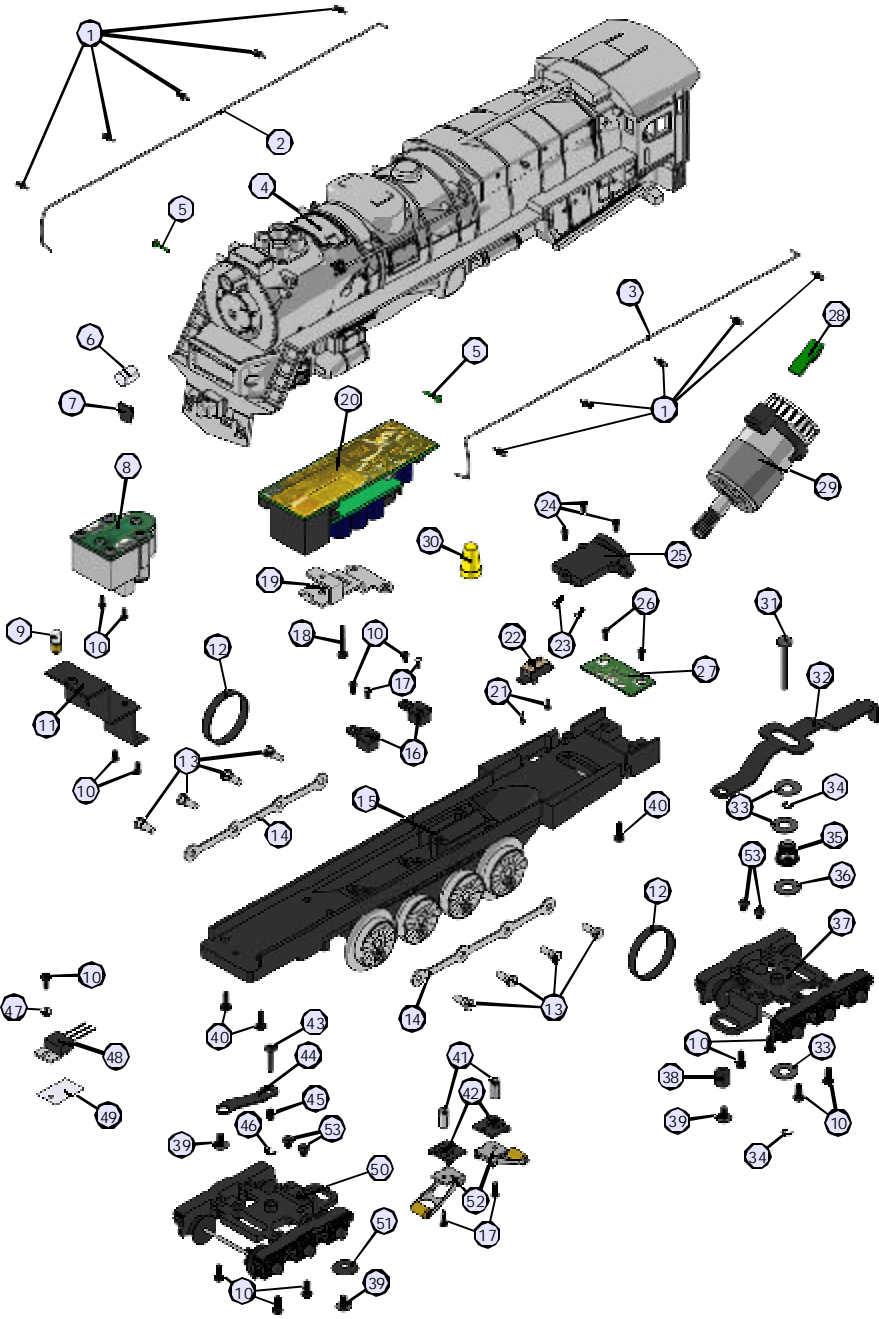

6-8-6 Bantam Turbine Steam Locomotive Tender Parts

Name and Number	Part #
1.) Shell (Brunswick green) (plastic) (Pennsylvania)	GA-1200069
2.) Weight (black) (metal) (34.4x39.3x19.8mm) (w/3 hole stamped for 4/40 screws)	II-0000015
3.) Wire harness (black male 10 pin plug)	BC-1200105
4.) Screw (4/40x6.0mm) (round head)	IA-0000003
5.) Battery charger jack (black)	BG-0000001
6.) Screw (M2x4.0mm) (round head)	IA-0000058
7.) Spacer (black) (3.0x6.0x4.0mm) (plastic)	ID-0000071
8.) Volume pot (small) (blue)	BI-0000040
9.) Screw (M3x8.0mm) (round head)	IA-0000035
10.) Speaker (STAR) (PR-050-A111) (16 ohms) (MAX2W)	BF-0000007
11.) Speaker cone (black) (44.0x48.3x23.0mm) (2 screw hole tabs) (plastic)	BF-0000016
12.) Screw (M3x6.0mm) (round head)	IA-0000016
13.) Battery leads (60.0mm long wires w/black male 2 pin plug) (45.0mm long wires w/battery charger jack)	BC-0000101
14.) Battery	BG-4000001
15.) Bracket (battery)	IH-0000042
16.) Screw (M3x4.0mm) (round head)	IA-0000010
17.) Gasket (black) (speaker ring) (43.8x49.8x3.0mm) (foam)	IB-0000009
18.) Chassis (black) (tender) (has holes for battery charger jack)	GB-1200048
19.) Screw (M3x16.0mm) (washer head) (self-drilling threads)	IA-0000025
20.) T-bar	IG-0000001
21.) Coupler (Proto Sound® 2.0) (51.0mm long)	DD-0000032
22.) Spring (nickel) (6.5x14.0mm) (w/0.5mm thick wire)	IE-0000022
23.) Washer (4.5x10.0x5.0mm)	ID-0000009
24.) E-clip (3.0x8.0x0.5mm)	IF-0000001
25.) Screw (6/32x6.0mm) (washer head)	IA-0000214
26.) Truck (black) (3 axle) (leading/trailing) (tender)	DA-1250005
27.) Drawbar (60.7x10.0x1.2mm) (1 step, 2 bends) (2 large holes, 1 small hole)	GA-1200027
28.) Wire strap (black) (8.0x16.0mm) (6.0mm step)	IH-0000256
NS.) Axle bearing (black) (3 axle) (plastic)	DC-0000005

6-8-6 Bantam Turbine Steam Locomotive Tender Parts

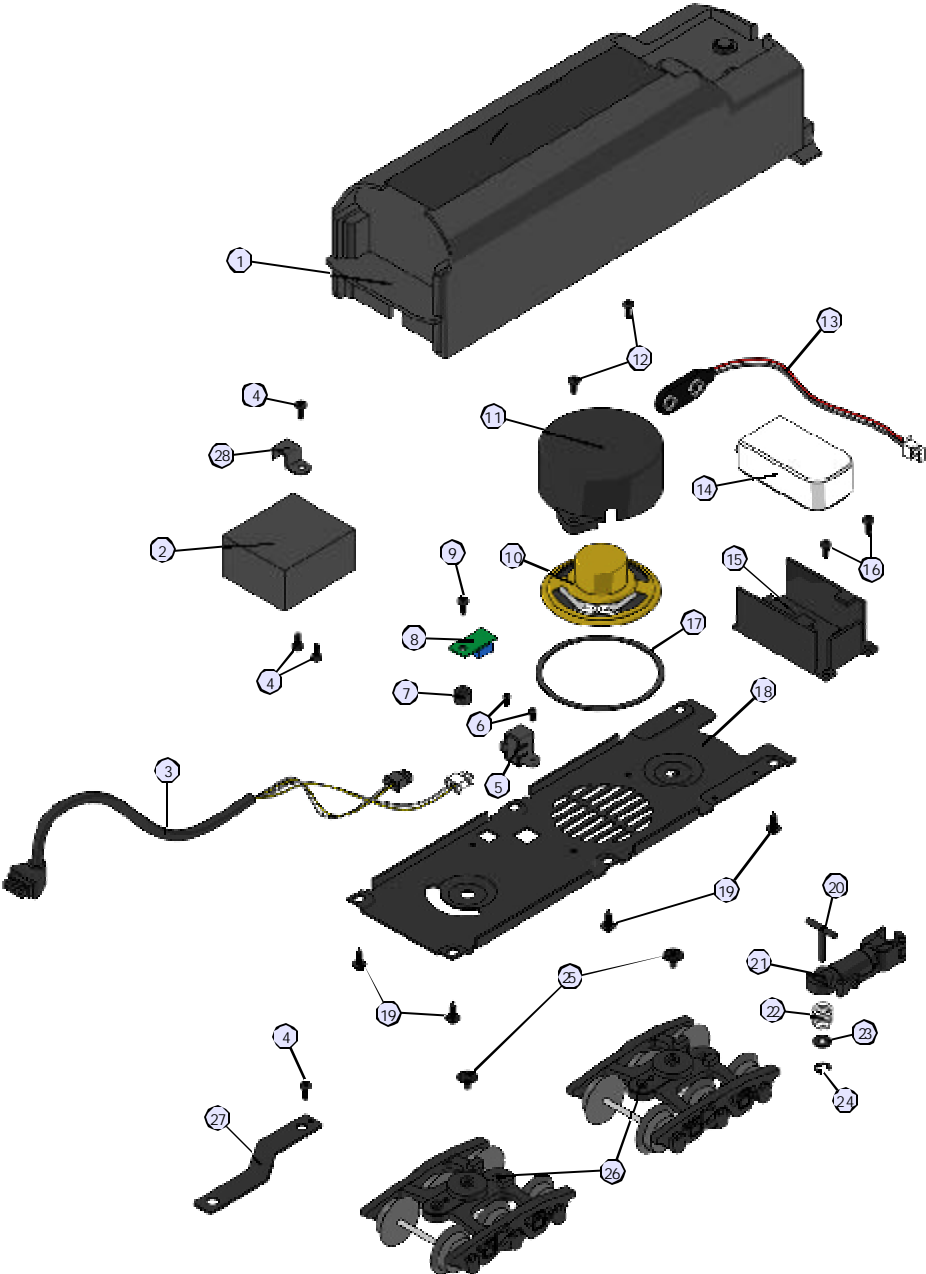

Service & Warranty Information

How to Get Service Under the Terms of the Limited One-Year Warranty

For warranty repair, follow the instructions below to obtain warranty service.

First, e-mail, write, call or fax an Authorized M.T.H. Service Center in your area or M.T.H. Electric Train to obtain Repair Authorization. You can find the list of Authorized Service Centers on the M.T.H. website, www.mth-railking.com. Authorized Service Centers are required only to make warranty repairs on items sold from that store; all other repairs may or may not be done at the store's own discretion. Otherwise, contact M.T.H. (fill out the Service Contact form in the Service Section of www.mth-railking.com; send US mail to the address listed below; tel: 410-381-2580; fax: 410-423-0009), stating when the item was purchased and describing the problem. If you contact M.T.H., you will be given a return authorization number to assure that your merchandise will be properly handled upon its receipt.

CAUTION: Make sure the product is packed in its original factory packaging including its foam and plastic wrapping material so as to prevent damage to the merchandise. The shipment must be prepaid and we recommend that it be insured. *A cover letter including your name, address, daytime phone number, e-mail address (if available), Return Authorization number, a copy of your sales receipt and a full description of the problem must be included to facilitate the repairs. Please include the description regardless of whether you discussed the problem with a service technician when contacting the Service Center or M.T.H. for your Return Authorization.*

Please make sure you have followed the instructions carefully before returning any merchandise for service.

Limited One-Year Warranty

All M.T.H. products purchased from an Authorized M.T.H. Train Merchant are covered by this warranty.

See our website at www.mth-railking.com or call 1-888-640-3700 to identify an Authorized M.T.H. Train Merchant near you.

M.T.H. products are warranted for one year from the date of purchase against defects in material or workmanship, excluding wear items such as light bulbs, pick-up rollers, batteries, smoke unit wicks, and traction tires. We will repair or replace (at our option) the defective part without charge for the parts or labor, if the item is returned to an Authorized M.T.H. Service Center or M.T.H. Electric Train within one year of the original date of purchase. This warranty does not cover damages caused by improper care, handling, or use. Transportation costs incurred by the customer are not covered under this warranty.

Items sent for repair must be accompanied by a return authorization number, a description of the problem, and a **copy of the original sales receipt from an Authorized M.T.H. Train Merchant**, which gives the date of purchase. If you are sending the item to M.T.H., fill out the Service Contact form in the Service Section of www.mth-railking.com; send US mail to the address listed below; call 410-381-2580, or fax 410-423-0009 to obtain a return authorization number. If you are sending this product to an Authorized Service Center, contact that Center for their return authorization.

This warranty gives you specific legal rights, and you may have other rights that vary from state to state.

Service Department





AUTHORIZED SERVICE CENTER

7020 ColumbiaGateway Dr. - Columbia,MD 21046

Information: 410-381-2580 Fax:410-381-6122

www.mth-railking.com

PARTICIPATING RETAILER LIST

ALABAMA

SOUTHERLANDSTATION
HUNTSVILLE
256-533-4720
railway@bellsouth.net

ARIZONA

ARIZONATRAINDEPOT
MESA
480-833-9486
sales@arizonatraindepot.com
www.arizonatraindepot.com/

CALIFORNIA

DOLLHOUSES, TRAINS & MORE
NOVATO
415-883-0388
kbecker@cmc.net

TINPLATEJUNCTION
OAKLAND
510-444-4780
TOYTRAINS@email.msn.com

COLORADO

MIZELL TRAINS Inc
WESTMINSTER
303-429-4811
mizelltrains@cs.com
www.mizelltrains.com

CONNECTICUT

SHELTONRAILROADSYSTEMS
SHELTON
203-924-8761
adriani@clearlight.com
NEWENGLANDHOBBYSUPPLY
MANCHESTER
860-646-0610
bobbell@nehobby.com

DELAWARE

KRRB MODEL TRAINS INC.
NEWARK
302-292-2779
info@krrb.com
www.krrb.con

FLORIDA

DEPOTHOBBIYSHOP
LAKEWORTH
561-585-1982
jimmy1982@aol.com
www.depothobbies.com

COLONIALPHOTO&HOBBY
ORLANDO
407-841-1485
trains@colonialphotoandhobby.com

WARRICKCUSTOMHOBBIES
PLANTATION
954-370-0708
info@warrickcustomhobbies.com
www.warrickcustomhobbies.com

FRANK'S TRAINS & HOBBIES INC.
OLDSMAR
813-855-1041
FTH@allhobbies.com
www.allhobbies.com

READYTOROLL
MIAMI
305-688-8868
rtrtrains@aol.com
www.readytorolltrains.com

ILLINOIS
BIKE & CHOOCHOO CONNECTION
SCHAUMBURG
847-882-7728
trainconnection@aol.com

INDIANA

Y. O. R. K. TRAINS
MUNSTER
219-838-9999
yorktrains@aol.com

SAMUELSON'S TRAINSHOP
VALPARAISO
219-462-2708

LOUISIANA

AMERICA'S TRAINYARD
BATON ROUGE
225-926-5592

MAINE

WHEELS, WINGS & THINGS
LUDLOW
207-532-6277
irc44@javanet.com

MARYLAND

ENGINEHOUSEHOBBIES
GAITHERSBURG
301-590-0816
luciecerise@aol.com

J & B TRAINS
HAGERSTOWN
240-420-4930

HOBBYTOWNUSA
FREDERICK
301-694-7395

PURKEY'S TOY TRAINS
SYKESVILLE
410-549-6061
wiley@oldmainline.com

THE TRAIN ROOM
HAGERSTOWN
301-745-6681

MASSACHUSETTS

NORTHEAST TRAINS
PEABODY
978-532-1615
www.netrains.com

MICHIGAN

BRASSEUR ELECTRIC TRAINS INC.
SAGINAW
517-793-4753
bob@traindoctor.com
www.traindoctor.com

MISSOURI

SWITCHSTAND
SAINTLOUIS
314-781-4458
r41877@earthlink.com

MARKTWAINHOBBYCENTER

ST. CHARLES
636-946-2816
webmaster@hobby1.com
www.hobby1.com

NEWHAMPSHIRE

TREASUREDTOYS
SALEM
603-898-7224
ttoys@treasured-toys.com
www.treasured-toys.com

RAILROADSPECIALTIES

HUDSON
603-882-5566
crew@electric-trains.com
www.electric-trains.com

NEWJERSEY

TRAINS&THINGS
TRENTON
609-883-8790
trainsanthings@aol.com

GRANDCENTRALSTATION

KEARNY
201-955-6200
228gene@gateway.com

HOBBYMASTERS,INC

REDBANK
732-842-6020
hobbymasters@hobbymasters.com

HOLLYBEACHTRAINDEPOT

WILDWOOD
609-522-2379
larry@pro-usa.net

COASTTRAINSANDCOLLECTIBLES

WALL
732-556-9005
coasttrain@aol.com
www.coasttrains.com

J&BTRAINS,INC.

MAPLESHADE
856-414-0092
BASE1130@aol.com

HOBBYSHOP

MATAWAN
732-583-0505
hobbyshopnj.com

ATLANTICRAILS

HAMMONTON
609-567-8490
bobcap@pics.com
www.atlanticrails.com

COUNTRYAND STUFF

ANDOVER
973-786-7086
stuff@crystal.palace.net

RIDGEFIELDHOBBY

RIDGEFIELD
201-943-2636

COLUMBUSTRAINSTATION

COLUMBUS
609-518-1800

NEWYORK

AURORARAILS&HOBBIES
EASTAURORA
716-652-5718
rk82141@aol.com

AMERICANASTORE

TIVOLI
845-757-4246
mthdepot@vals.tar.net

NASSAUHOBBYCENTER,INC.

FREEPORT
516-378-9594
Charlienassau@aol.com

KROSS HARDWARE

WESTBABYLON
631-669-3069
t989@aol.com

CITYDEPOT,INC.

NEWHAMPTON
845-374-3010
citydepot@frontiernet.net
www.citydepot.com

NORTHCAROLINA

DRYBRIDGESTATION
MOUNTAIRY
336-786-9811
mikek@drybridgestation.com
www.drybridgestation.com

THEFREIGHTYARD

SMITHFIELD
919-934-6229
disbissette@aol.com

TRAINS LTD.

CHARLOTTE
704-566-9070
modelrrs@bellsouth.net
www.trainsltd.com

THEROUNDHOUSE&BACKSHOP

CARY
919-465-0810

OHIO

DIXIEUNIONSTATION
MASON
513-459-0460
rockylane@core.net
www.dixieunionstation.com

RICK'STOYTRAINS

TOLEDO
419-478-0171

T&KHOBBIYSHOP

BRIDGEPORT
740-633-6607
salea@tkhobbies.com
www.tkhobbies.com

TRAINS-N-THINGS

CANTON
330-499-1666
trains@ssnet.com

PARMAHOBBY

CLEVELAND
216-741-6440
info@parmahobby.com

GLEN'STRAINSHOP

AKRON
330-253-6527

E & STRAINS

AKRON
330-745-0785

GRANDPACIFICJUNCTION

OLMSTEAD FALLS
440-235-4777
gpjmrr@juno.com
HUDSONTOY,TRAIN&HOBBY
HUDSON
330-653-2997
ejpickens@aol.com

DAVISELECTRONICS

MILFORD
513-831-6425
davisstrains@fuse.net
www.davisstrains.com

SANDY'SHOBBY'S&COLLECTIBLES

ELYRIA
440-365-9999
sandyshobb@aol.com

ERIERAILWAYDEPOT

TROY
937-440-9972
orvile@gte.net

CLEARVIEWTRAIN&HOBBY

LORAIN
440-277-4488
klogar@erienet.net
www.clearviewtrainandhobby.com

PENNSYLVANIA

FAIRCHANCEPHARMACY
FAIRCHANCE
724-564-7817
mthdealer@aol.com
www.hhs.net/fairchance

THESTATION

NEWCUMBERLAND
717-774-7096

station@paonline.com
BUSSINGERTRAINS
AMBLER

215-628-2366
choochoos@icdc.com
www.icdc.com/~btrains

CHARLEROISSWEEPERCENTER

CHARLEROI
724-483-3397

AMERICANHOBBYCENTER

ALIIQUIPPA
724-378-3930

american@icubed.com

CRANBERRYHOBBYDEPOT

CRANBERRYTWP
724-776-3640

JAdams6113@aol.com

ALLENTOWNTYOYTRAIN SERVICE

ALLENTOWN
610-821-0740

ONTHERIGHTTRACK

ALTOONA
814-942-4345

JIM'STRAINSHOP

HOMERCITY
724-479-2026

sudsy@stargate.net

YEOLDETRAIN&CHRISTMAS

SHOPPE
BOYERTOWN
610-369-0755

www.yeoldetrain.com

TOBYTYLER'S HOBBYCENTER

PITTSBURGH
412-653-5030

tobytyler111@cs.com

BUSTLETONTRAINSHOP

PHILADELPHIA
215-698-7266

CHESTNUTTOYBOX

PHILADELPHIA

215-545-0455
chestnuttoy@earthlink.net

THECABOOSE

LEHIGHTON

570-386-5352
www.thecaboosehobbies.com
victen@ptd.net

SOUTHCAROLINA

EMERALD TRAIN & HOBBY
GREENWOOD
864-223-2247

TENNESSEE

MODEL RAILROAD&HOBBYSHOP
MEMPHIS

901-384-6500
mrhs99@earthlink.net
www.modelrailroadandhobby.com

TEXAS

HOBBY TIME

AMARILLO
806.352.9660

don.l.harris.@hobby-time.com

VIRGINIA

TRAINDEPOT

MANASSAS
703-335-2216

NORGE STATION

WILLIAMSBURG

757-564-7623

norgetrains@cs.com

NUTBUSHEXPRESS

VICTORIA

804-696-1902

thenutbushexp@meckcom.net

TOYTRAINCENTER

RICHMOND

804-288-4475

TSGHOBBIES

WARRENTON

540-347-9212

tripi@mnsinc.com
www.mnsinc.com/tripi/tsg.htm

CHESTERFIELDHOBBIES

MIDLOTHIAN

804-379-9091

chsthobb@erols.com
www.chesterfieldhobbies.com

DAVIS HOBBYSUPPLIES

PORTSMOUTH

757-397-1983

ralph@davishobby.com
www.davishobby.com

LOCUSTGROVETRAINS

LOCUSTGROVE

540-854-8955

lgtrains@aol.com
www.locustgrovetrains.com

WESTVIRGINIA

PATRICK'STRAINS

WHEELING

304-232-0714
trains@patstrains.com
www.patstrains.com

WISCONSIN

SOMMERFELD'STRAINS
BUTLER

262-783-7797
questions@sommerfelds.com
www.sommerfelds.com

GB TV&TRAINS

GREENBAY

920-496-9697

rrtycoon@netnet.net

GRAMPA'STRAINSHOP

RICE LAKE

715-234-2996

grampastrainshop@yahoo.com

THE TRAINSTORE

WAUKESHA

262-650-6675

HOBBYOUTLET

FONDDULAC

920-924-3770

hobby_outlet@hotmail.com

CANADA**ONTARIO**

CREDITVALLEYRAILWAYCOMPANY

STREETSVILLE

905-826-1306

CVRCO@globalserve.net
www.cvrco.com

TOY TRAINWORKSHOP

CUMBERLAND

613-833-3125

info@toytrainworkshop.com
www.toytrainworkshop.com

THE TRAINROOM

FERGUS

519-787-3280