

Table of Contents

Contents Of The Kit	3
Required Tools.....	6
Locomotive Inspection & Review	7
Preparing The Tender For The Upgrade	8
Installing The Ps-2 Components Into The Tender	9
Mounting The Ps-2 Board.....	10
Installing The Proto-Coupler.....	13
Coupler Installation.....	14
Optional Front Proto-Coupler Wiring.....	15
Installing The Tender Harness.....	16
Soldering Speaker Connections.....	19
Installing The Battery & Volume Pot.....	20
Preparing The Locomotive For The Upgrade	22
Determining The Locomotive Motor Type.....	23
Installing The Tach Reader Bracket.....	23
Installing The Flywheel Tach Tape.....	24
Mounting The Tach Reader To The Tach Bracket.....	25
Installing The Ps-2 Harness Into The Locomotive	26
Mounting The Ps-2 Harness Connector.....	26
Connecting Motor, Ground & Pickup Wires.....	27
Installing Headlight Into RailKing Steam Engines.....	28
Connecting The Ps-2 Harness To The Smoke Unit.....	29
Other Proto-Smoke Circuit Wiring Methods.....	30
Connecting Power To The Constant Voltage Board.....	31
Wire Management/Short Circuit Prevention.....	32
Testing The Ps-2 Installation	33
Loading Proto-Sound 2.0 Files Into Locomotive	34
Proto-Sound 2.0 Operation Instructions	37
Conventional Operation.....	37
Self-Recharging Battery.....	43
Troubleshooting.....	44
Service & Warranty Information	47
Warranty Coverage & Service Options.....	47

WARNING: This product is not covered by a warranty unless installed by an M.T.H. Authorized Conversion Center.

CAUTION: ELECTRICALLY OPERATED PRODUCT:
Recommended for Ages 14 and up. Not recommended for children under 14 years of age without adult supervision. As with all electric products, precautions should be observed during handling and use to prevent electric shock.

WARNING: When using electrical products, basic safety precautions should be observed, including the following:
Read this manual thoroughly before using this device.

- 1 M.T.H. recommends that all users and persons supervising use examine the hobby transformer and other electronic equipment periodically for conditions that may result in the risk of fire, electric shock, or injury to persons, such as damage to the primary cord, plug blades, housing, output jacks or other parts. In the event such conditions exist, the train set should not be used until properly repaired.
- 1 Do not operate your layout unattended. Obstructed accessories or stalled trains may overheat, resulting in damage to your layout. This train set is intended for indoor use. Do not use if water is present. Serious injury or fatality may result.
- 1 Do not operate the hobby transformer with damaged cord, plug, switches, buttons or case.

This product may be protected by one or more of the following patents: 6,019,289; 6,280,278; 6,281,606; 6,291,263; 6,457,681; 6,491,263; 6,604,641; 6,619,594; 6,624,537; 6,655,640.

©2010, M.T.H. Electric Trains®, Columbia, MD 21046

Contents Of The Kit

- A) Proto-Sound 2.0 (Ps2) board (1)
- B) Ps2 plastic mounting bracket (1)
- C) Tender harness (1)
- D) Ps2 metal heat sink bracket (1)
- E) Proto-Coupler, long (1)
- F) Back-up light (1)
- G) Tender Marker Light Harness w/2 LEDs (1)
- H) Locomotive Harness w/Tach Reader (1)
- I) Speaker, 4 ohm 50mm diameter (1)
- J) Headlight (1)
- K) Tach reader brackets (2)
- L) Tach tape stripes (4)
- M) AA battery pack (1)
(Charge before use)
- N) Screws M2 x 4 mm (2)
- O) Screws 6/32 x 6 mm (3)
- P) Nuts 6/32 (3)
- Q) Screw 6/32 x 8 mm (1)
- R) Plastic Wire Sleeve
(for wire management) (1)
- S) Shrink tubing (1)
- T) Foam tape (1)
- U) Wire Ties (7) (6) 4", (1) 7"
- V) Inductor (1)
- W) Headlight Grommet
- X) Battery Recharging Port/Harness
- Y) Battery Recharging Port Hardware
(2) Screws M3 x 12, (2) Nuts M3, (2)
Spacers
- Z) Locomotive Harness Spacer/Insulator
- AA) Pittman Tach Reader Screws (2)
- EE) Coupler Insulator

(A)Proto-Sound 2.0 Circuit Board
AE-0000010, AE-0000011

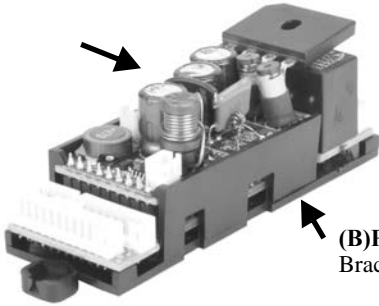

**(B)Ps-2 Plastic Mounting
Bracket (IH-0000391)**

**(AA)Pittman Motor Tach
Bracket Screws**
(IA-0000375)



(C) Tender Wiring Harness
(BC-1000005)

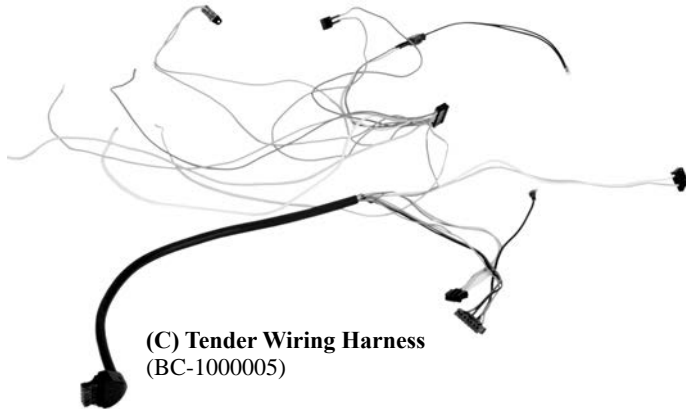



(D) Ps-2 Metal Heat Sink Bracket
(IH-0000390)

(E) Proto-Coupler
(DD-0000032)



(F) Tender Backup Light
(CF-0000030)

(EE) Coupler Insulator
(ID-0000123)

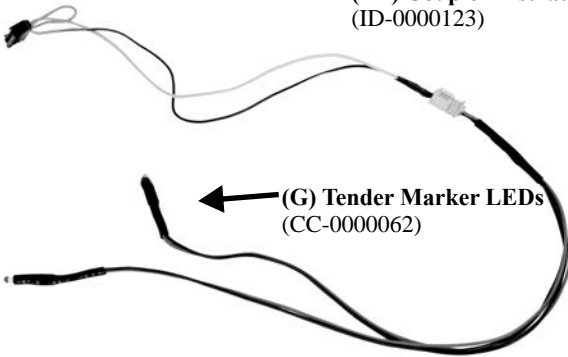

(G) Tender Marker LEDs
(CC-0000062)

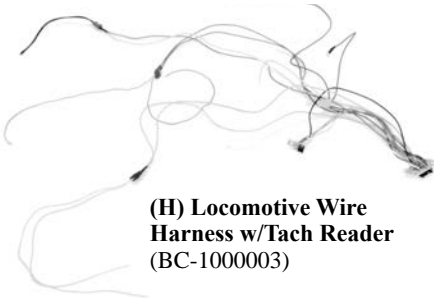

(H) Locomotive Wire Harness w/Tach Reader
(BC-1000003)

(I) Speaker
(BF-0000034)



(J) Locomotive Headlight
(CA-0000078)

(K) Tach Reader



Pittman
(IH-0000154)



Mabuchi / IDG
(IH-0000389)

(L) Tach Tape
(BE-0000151)

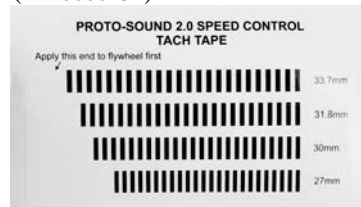



(M) AA Battery Pack
(Charge before use)
(BG-4000003)

(N) M2 Screws
(IA-0000058)



(O) 6/32 x 6mm Screws
(IA-0000027)



(R) Plastic Wire Sleeve



(P) Nuts
(TP-M500075)



(Q) 6/32 Screw x 8mm
(IA-0000050)



(S) Shrink Tubing

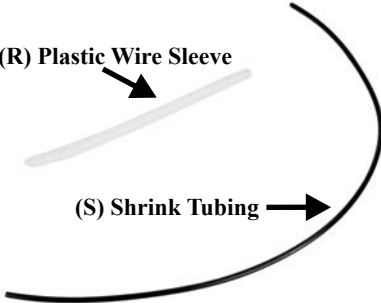

(T) Foam Tape

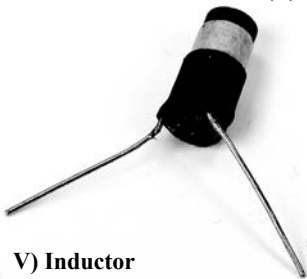
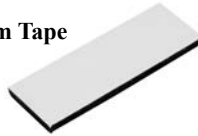

(V) Inductor
(AI-0000044)



(U) Wire Ties



**(X) Battery Recharging
Port & Harness**
(BC-1000004)



(W) Headlight Grommet
(IH-0000010)



(Y) Recharging Port Hardware
(Spacer: ID-0000071)
(Screw: IA-0000035)
(Nut: IC-000006)



(Z) Loco Harness Spacer
(BD-0000065)

Required Tools

Soldering iron
ESD safe work area
White thermally conductive grease
Screw drivers, Philips #2 & #00
Wire cutters
Drill
Drill bits (1/8", 5/32")
Drill bit (3/8" or 1/2") or de-burring tool
Allen key (1.5 mm for Pittman motor flywheel set screw)
Electrical Tape
Razor Saw

What Is An ESD?

As ESD safe work area is an area set aside in your workshop that is electrically grounded and includes anti-static mats and grounding straps

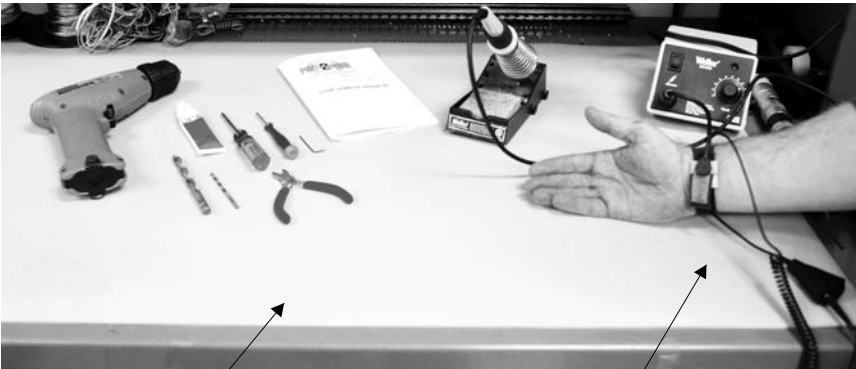

ESD Mat

Work Only in an ESD Safe Zone

Grounding Strap

Inspection & Review

Before beginning the installation, Inspect the engine and tender to be upgraded and verify the following are in good working order:

- Pick-up rollers
- Motor w/flywheel
- Smoke unit
- Speaker mounting hardware
- Volume pot
- Coupler mounting hardware, “T” bar, spring, c-clip
- Constant voltage lighting board and connected bulbs.

Note: If any of the above items are missing or not in working order, procure the required parts before continuing.

Note: Before beginning installation, see discussion on page 32 on “wire management” which should be planned as you proceed during the installation. Part of the plastic wire tube (R) may be used for this purpose.

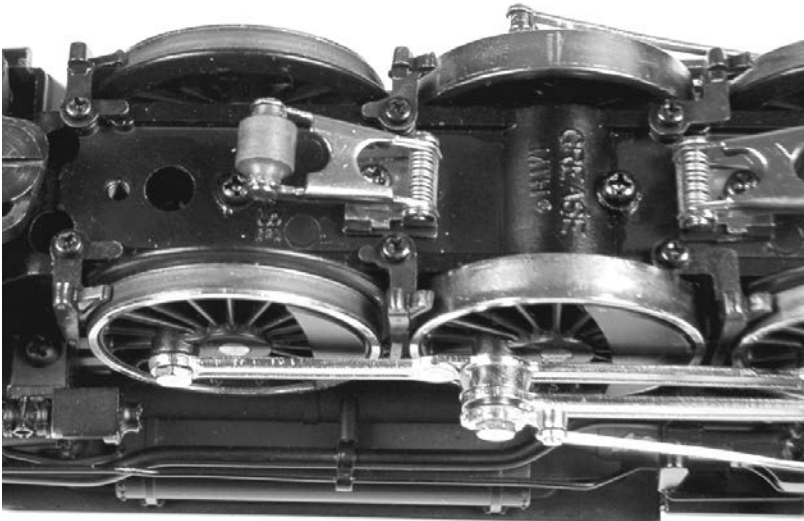

Make sure pickup rollers are clean & lubed and roll freely.

Preparing The Tender For The PS-2 Upgrade

Before you can install the Ps2 components into your tender, any existing sound boards or reversing units must be removed. The Ps2 Kit contains all the necessary electronics your locomotive requires to operate. Some existing mounting brackets may be utilized during the installation of the Ps2 components. Follow the instructions below taking care to save the parts when noted.

Remove The Following Items From The Tender Chassis

Tender shell (save the mounting screws).

Proto-Sound 1, DCRU Reverse Unit, Mechanical Whistle, Electronic Whistle, any other electronics and tender harnesses.

Speaker (save mounting hardware).

Existing coupler (save the “T” bar, spring, and c-clip).

Any lights including the rear back-up light and marker LEDs (if present). These will likely be mounted inside the tender shell.

Do NOT remove the volume pot used on Proto-Sound 1 models.

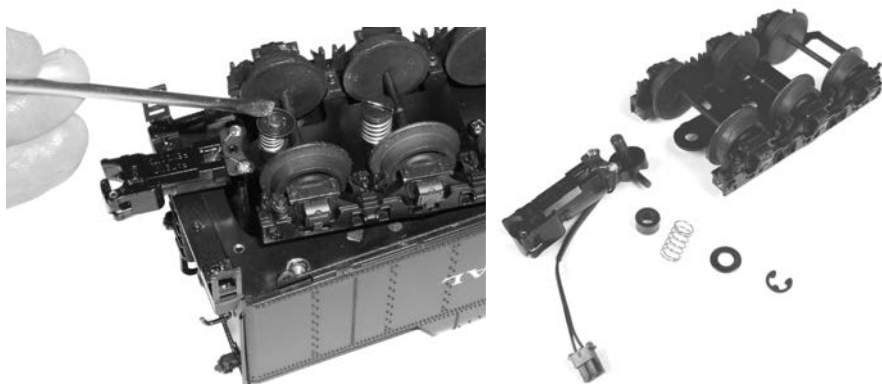

Remove the old coupler by slipping off the “C”-clip from the coupler “T”-Bar. If your locomotive does not have a volume pot, order BI-0000040 (volume pot), IA-0000035 (screw), and ID-000071 (spacer), and IC-0000006(nut).

Installing The PS-2 Components Into The Tender

Required Upgrade Kit Components

- A) Proto-Sound 2.0 (Ps2) board (1)
- B) Ps2 plastic mounting bracket (1)
- C) Tender harness (1)
- D) Ps2 metal heat sink bracket (1)
- E) Proto-Coupler, long (1)
- F) Back-up light (1)
- G) Tender Marker Light Harness w/2 LEDs (1)
- I) Speaker, 4 ohm 50mm diameter (1)
- M) AA battery pack (1)
- O) Screws 6/32 x 6 mm (3)
- P) Nuts 6/32 (3)
- Q) Screw 6/32 x 8 mm (1)
- R) Plastic Wire Sleeve (for wire management) (1)
- S) Shrink tubing (1)
- T) Foam tape (1)
- U) Wire Ties (7) (6) 4", (1) 7"
- X) Battery Recharging Port/Harness
- Y) Battery Recharging Port Hardware (2) Screws M3 x 12, (2) Nuts M3, (2) Spacers
- EE) Coupler Insulator



Typical component arrangement on tender floor. Note position of heat sink.

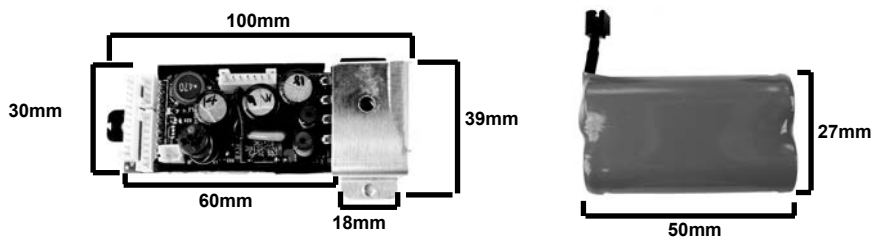

Mounting The PS-2 Board

Remove the Ps2 Board (A) from the sealed anti-static bag

Verify Ps2 board is securely inserted into the plastic mounting bracket (B)

NOTE: If you are not a participating MTH Authorized Service Center there is NO warranty once the bag is opened

NOTE: Use ESD safe work area and procedures when handling the PS2 board.

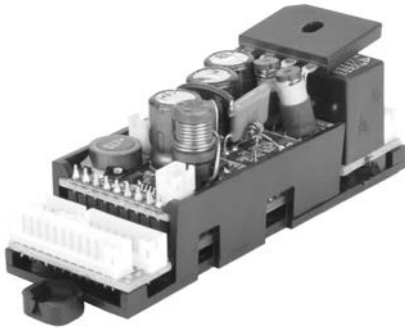

Make sure the Ps-2 board is firmly inserted into the plastic mounting bracket. If not, gently push the board into the bracket until fully "captured" by the bracket. DO NOT REMOVE THE BOARD FROM THE BRACKET.

Remove the speaker (K) from the protective packaging (NOTE: be careful not to damage the speaker cone)

Place the Ps2 board/plastic mounting bracket (A/B) in the tender to verify the best location to mount the plastic mounting bracket (B) and the metal heat sink bracket (C) to the tender floor. Also locate a place to put the battery pack (M) and battery charging jack (X).

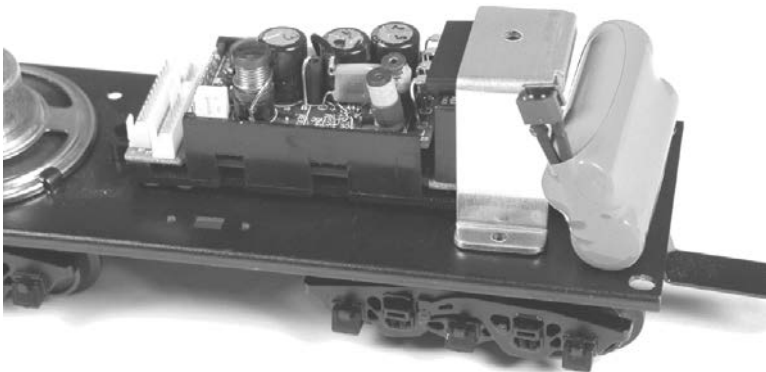

Place the components on the tender floor in the best position given the space. It may be necessary to turn the battery pack on its side as seen above.

Mounting The PS-2 Board *Cont'd*

Once you have determined the best locations for mounting the plastic bracket (B), metal heat sink bracket (D), battery pack (M), and battery charging jack (X), mark the tender floor locations using a pencil or silver marker so you can drill the holes in the proper locations.

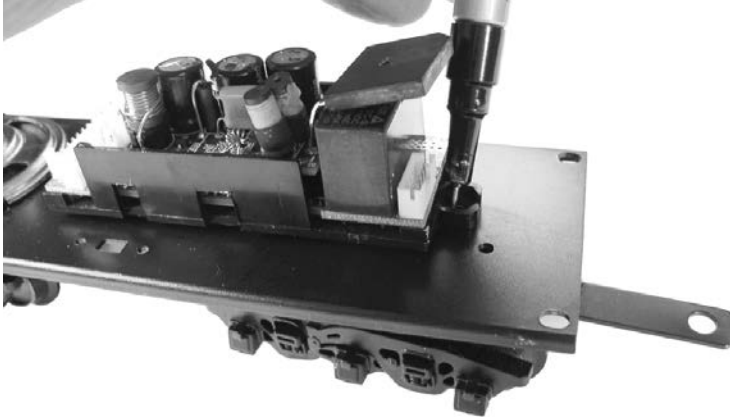

Drill the appropriate mounting holes as determined from positioning the Ps-2 board and other components

Remove the Ps2 board (A) with plastic mounting bracket (B), metal heat sink bracket (D), speaker and battery from the tender and place on an ESD safe area on your workbench.

Drill the holes as marked with the proper drill size. A 5/32" bit will be required for the Ps2 plastic mounting bracket (B) and heat sink bracket (C). Use a 1/8" bit for the battery charging jack mounting holes.

De-burr the holes slightly using a larger drill bit (3/8") or a deburring tool.

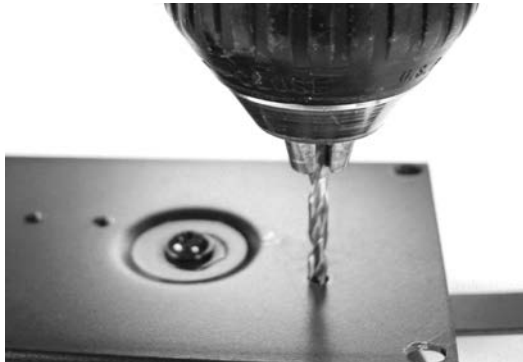

Carefully remove any metal burrs resulting from drilling the mounting holes. Loose metal burrs can damage the Ps-2 circuit board!

Mounting The PS-2 Board *Cont'd*

Mount the plastic mounting bracket (B) containing the PS2 board (A) using the 2 of the screws (O) and nuts (P)

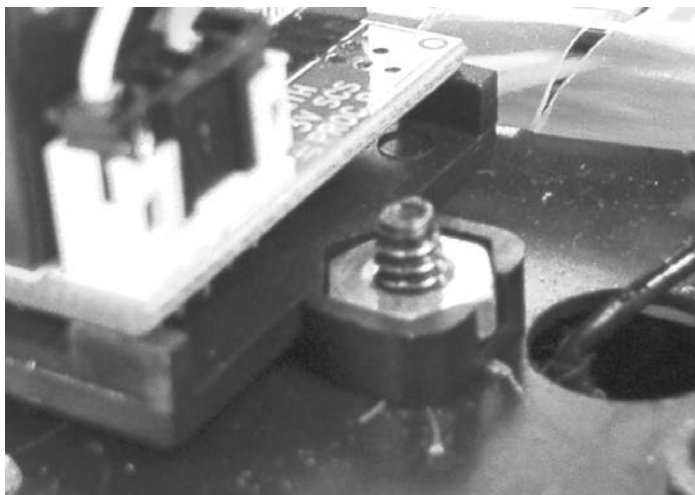

Mount the PS-2 plastic mounting bracket



Apply white thermally conductive grease to the bridge rectifier on the PS2 board.

Apply white thermally conductive grease to bridge rectifier & metal heat sink bracket.

Mounting The PS-2 Board *Cont'd*

Secure the metal heat sink bracket (D) to the bridge rectifier using screw (Q)

Note, if screw is too long, cut it down so it does not hit the relay



Apply thermal conductive grease to the metal heat sink bracket surface that contacts the frame and mount to the tender frame using screw (O) and nut (P).

Installing The Proto-Couplers

Install the proto-coupler (E) onto the existing tender trailing truck or coupler mount location using the existing hardware. Be sure to route the coupler wire harness through the tender floor.

Connect black Proto-Coupler connector to black tender harness connector on the brown & purple wires.

Note: Use coupler insulator as required to prevent shorts from coupler solder connections to tender truck axle.



The Proto-Coupler installs in the same location as the original engine coupler.

Coupler Installation

A plastic insulator, item EE in the parts list of your Proto-Sound 2.0 Upgrade Kit has been included with the rest of your Ps2 Upgrade Kit parts.



Shown above is the coupler unassembled.

This insulator should be inserted between the coupler and the spring, washer and the C clip that holds the coupler to the T-Bar and truck bolster. The insulator prevents the coupler wiring from contacting and short circuiting against the truck's axle. Failure to insert the insulator could permanently damage the coupler and Ps2 board.

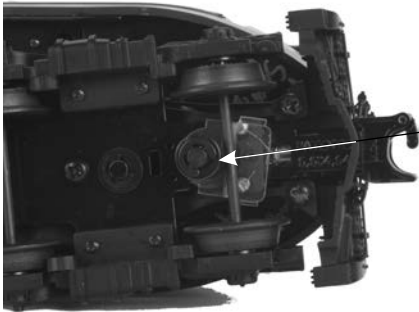
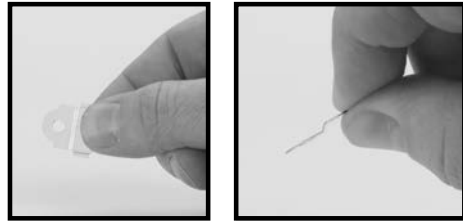

Shown here is the insulator attached to the truck and coupler. Ensure that the part of the insulator which protects the coupler's wires extends up not down when installed.

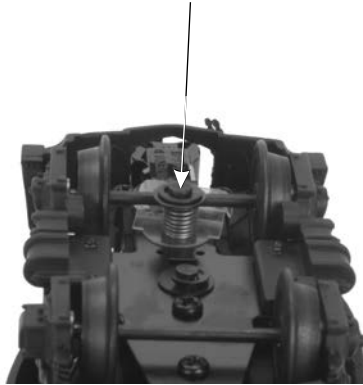

Optional Front Proto-Coupler Wiring

*If front proto-coupler is desired purchase a coupler DD-000032 and give up Headlight Control. Power headlight as it was powered prior to PS2 upgrade. Use the headlight connector (Blue) to control the front proto-coupler. Move the purple wire in the tender 12 pin connector from pin 5 location (purple wire next to green wire) to pin 9 location (between brown and blue wires).

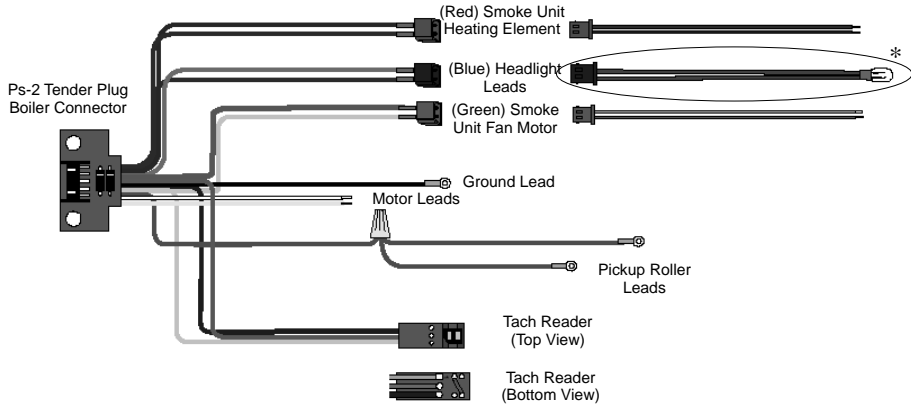

Engine Harness

**Move the purple wire in the tender 12 pin connector from pin 5 location (purple wire next to green wire) to pin 9 location (between brown and blue wires).

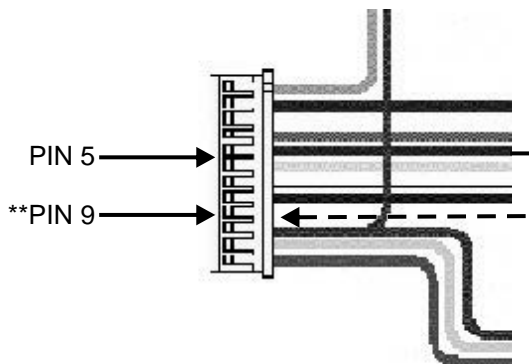

Tender Harness 12 Pin Connector

Installing The Tender Harness, Speaker, Switches & Lights

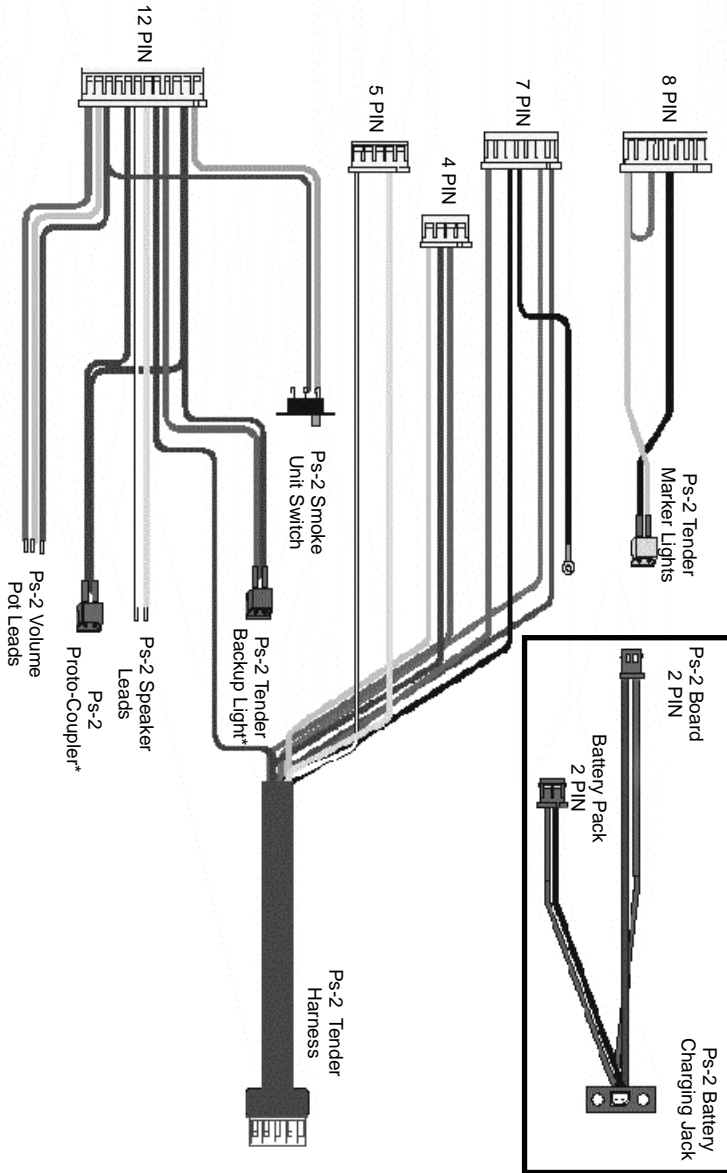

**Note: If tender has harness to connect an auxillary tender, connect the back-up light and coupler connectors to the harness. Use switch to select light/coupler operation in tender or auxillary tender.*

PS-2 Board Connections

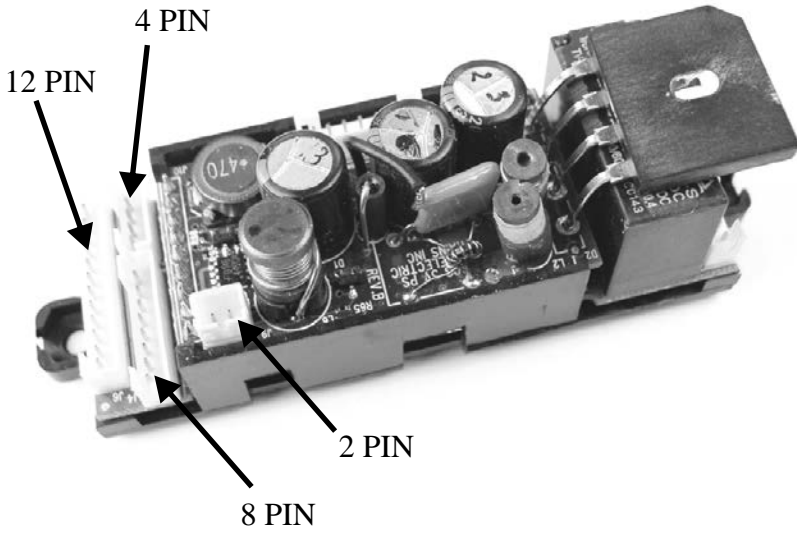
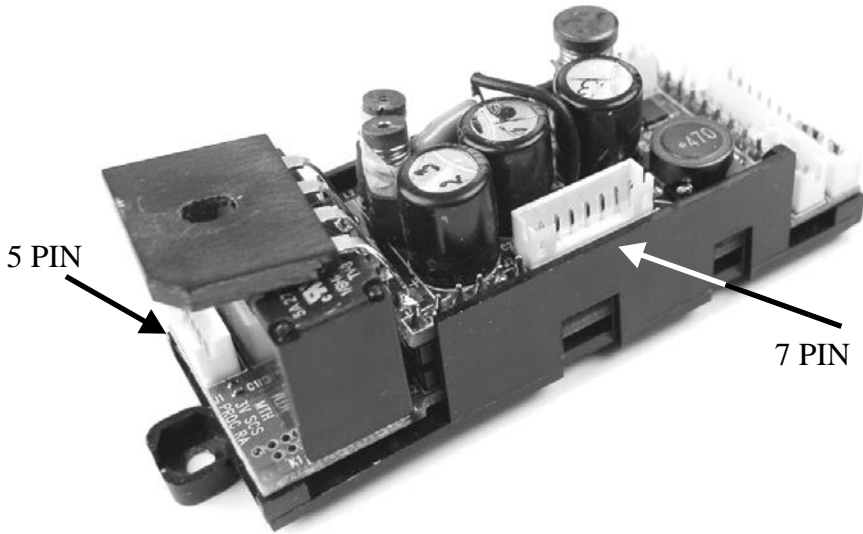

Installing The Tender Harness, Speaker, Switches & Lights

Attach tender harness (C) to the PS2 board (A) noting the connectors all should fit in their respective locations. See previous pages for locations.



Take care to insert the correct plug into the correct connector on the Ps-2 board. Each plug is polarized and has a different number of pins.

Install the speaker (I) into the previous speaker mounting location using the existing hardware.

Install the smoke unit switch (attached to the tender harness) in the tender frame cut out using screws (N). (If one does not exist, locate the switch in the best possible location.)

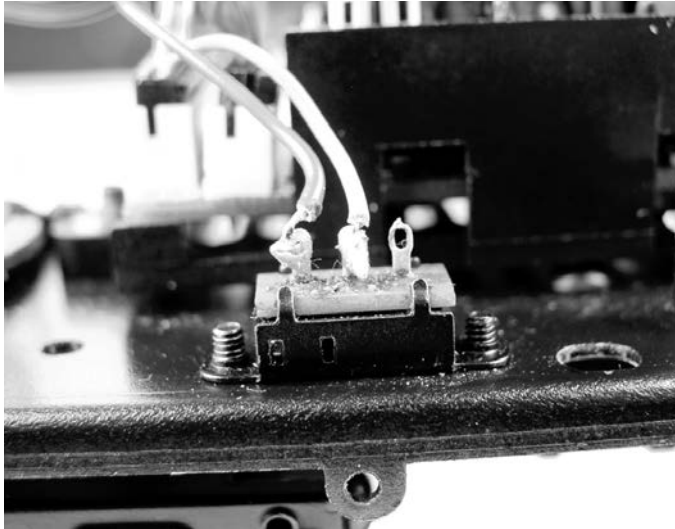

Mount the smoke unit switch into the existing switch hole on the tender floor using screws (N).

Install the rear back up light (F) with green connector and marker lights (G) with yellow connector as required in the model. Connect the backup light green connector and marker light yellow connector to the green and yellow Ps2 harness connectors, respectively. (Note if only 1 marker light is required, secure one of the LEDs from the wire harness inside the tender.)

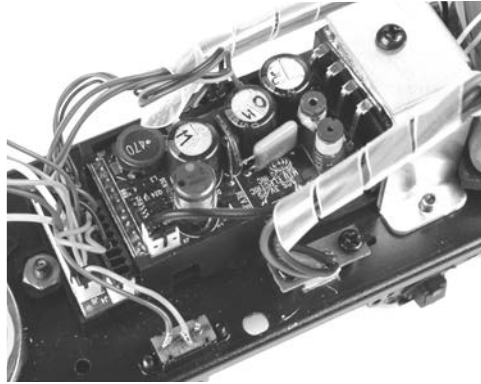

Ensure proper wire management by using pieces of plastic sleeve (R) to hold various cables in place.

Soldering Speaker Connections

Solder the yellow and white wires to the speaker (I) making sure to get the polarity correct, yellow(+) and white (-) and soldered wires do not short to speaker frame.

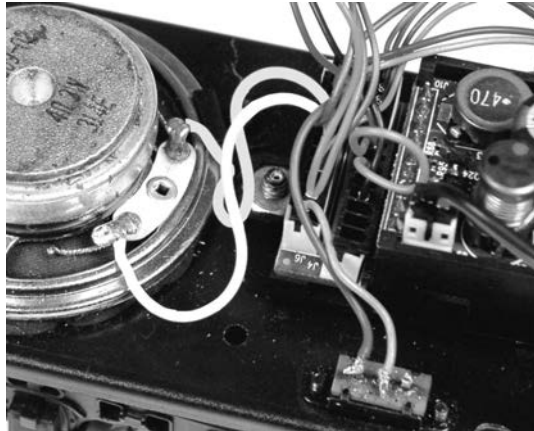

Ensure that the yellow speaker lead goes to the (+) speaker terminal and white to the (-) terminal.

WARNING: If either wire shorts to the speaker frame the PS2 electronics will be damaged.

Installing The Battery And Volume Pot

Plug the 2 pin battery pack connector into the Ps-2 board.

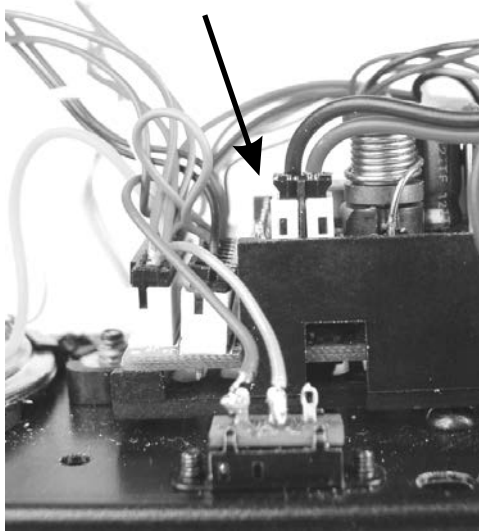

The battery pack connector comes pre-mounted to the recharging port (X) and battery pack cable. It plugs into the Ps2 Circuit board as indicated by the arrow.

Mount the 2 pin battery recharging jack (X) to tender floor as shown below.

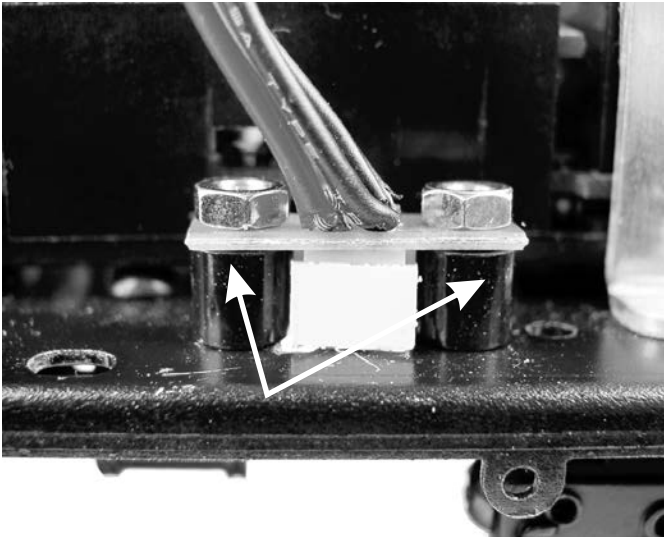

Insert the spacers (Y) between the recharging jack board and the tender floor to prevent the recharging jack port from extending below the tender floor. Secure with screws from underside of frame and nuts (Y).

Solder the red, blue and gray volume pot wires to the volume pot. Red to the center terminal and blue and gray to the outside terminals.

Place the double-sided foam tape (T) on the tender floor in the proper location established previously.

Secure the AA rechargeable battery pack (M) using double-sided foam tape.



Connect the battery harness to the battery pack. Note in the example above how the foam tape is also located between the volume pot and the battery pack.

Solder the wires to the existing volume POT. Red wire to the center terminal, blue to one outer terminal and gray to the other outer terminal.

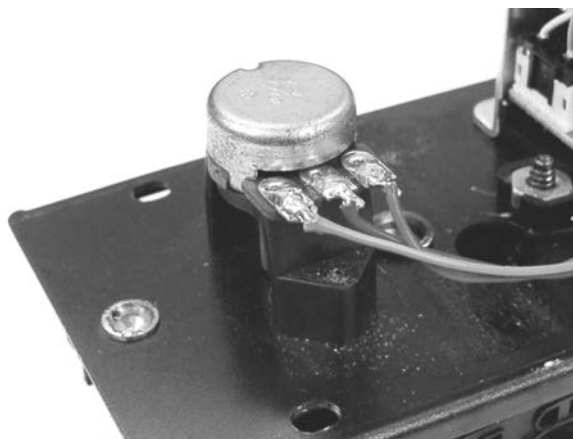

Note: Volume pot not required for command operation. Solder gray and red wires together to get full volume in conventional mode and insulate the blue wire from chassis ground.

Preparing The Locomotive For The Ps2 Upgrade

Remove The Following Items From The Engine

Boiler (save the mounting screws).

Headlight bulb and wire harness plug from the constant voltage board if present.

4 pin connector at the rear of the engine that connects to the tender harness (save the mounting screws).

Remove motor and unsolder the wires connected to the motor.

Remove the smoke unit (if present and retain all mounting hardware).
Unsolder wires to the smoke unit (if present).

Unsolder the wires to a smoke switch if present.

Note: Do not remove the constant voltage board & bulbs connected to it. These will be reused later as detailed on pg. 28.



Unsolder the motor leads at the motor and remove the 4-pin connector mounted at the back of the locomotive chassis.

Note: This would be a good time to grease the chassis gearbox and rotate the drive wheel assembly to verify that the drive assembly rotates freely. Follow the lubrication instructions in the locomotive's operator's manual. If some binding is found, correct before proceeding.

Determine Engine Motor Type

Verify which type of motor is present (Pittman or Mabuchi)

If the motor is a Pittman model (the Pittman name is printed on the motor label), remove the flywheel by loosening the set screw with the Allen Key.



Identify which type of motor the locomotive is equipped with. There are two Mabuchi sizes (middle and right) and one Pittman size.

The flywheel on the Pittman motor must be removed so that the Tach Reader bracket can be installed on the motor. It is not necessary to remove the flywheels on the Mabuchi motors.

Installing Tach Reader Bracket

Based on the motor type, install the correct tach reader mounting bracket. The bracket is screwed into place on a Pittman motor or snapped into place on a Mabuchi motor. The bracket is snapped into place by spreading it open and sliding it under the flywheel. It may be necessary to use tape or epoxy glue to hold in position.



Unscrew the top motor mount screws so that the tach reader bracket can be installed onto the Pittman motor.

Screw the Tach Reader bracket onto the top of the Pittman motor using screws (AA) as shown.

Installing Tach Reader Bracket

Small Mabuchi Motor



Spread the Tach Reader bracket apart and slip between the flywheel and motor for engines equipped with Mabuchi motors.



Push the bracket all way onto the top of the motor. The small tabs extending down will “lock” onto motor casing.

Large Mabuchi Motor

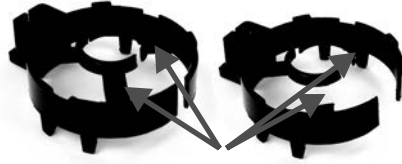

Some Mabuchi motors are larger than others and will require that the tach reader bracket be modified in order to fit around the motor. Cut the bracket straps as shown.



Slip the modified bracket around the motor and snap into place. It may be necessary to glue or tape the bracket in place.

Installing Tach Tape Onto Motor Flywheel

Clean the flywheel with a cleaning solution and then install the tach tape to the flywheel (measure flywheel diameter and select proper tape) Apply tape end with the largest white portion first, wrap the tape around the flywheel until it overlaps.

Reassemble the flywheel onto the drive shaft (Pittman motors only).



Mounting Tach Reader To Tach Reader Bracket

Insert the tach reader into the tach reader bracket.

The gap between the optical sensor and flywheel should be 0.5 mm (0.022") – 1.5 mm (0.060"); 0.75mm (0.030") is optimum.

If the gap is too small, remove the tach reader spacer as detailed below. This increases the gap by 2.2mm.

Spark plug feeler gauges are useful to establish the proper gap.



When inserted into the tach reader bracket, the distance between the tach reader and the flywheel should be between .5mm & 1.5mm.

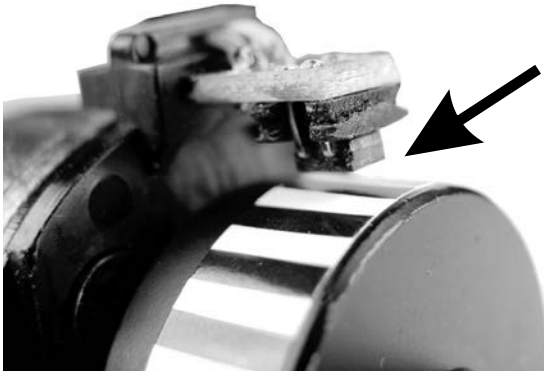

Check the distance between the flywheel and tach reader. Adjust if necessary as detailed below.



The tach reader spacer can be removed by unsoldering the tach reader prongs on either side of the spacer as seen above.



Once the spacer has been removed, resolder the tach reader to the tach reader circuit board.

Installing The Ps-2 Harness Into The Locomotive

Mounting Harness Connector

Mount the 10-pin connector to the back of the chassis using the screws that held the previous 4-pin connector in place. It may be necessary to use the spacer (Z) as a shim if the connector doesn't properly line up with the opening at the back of the boiler.

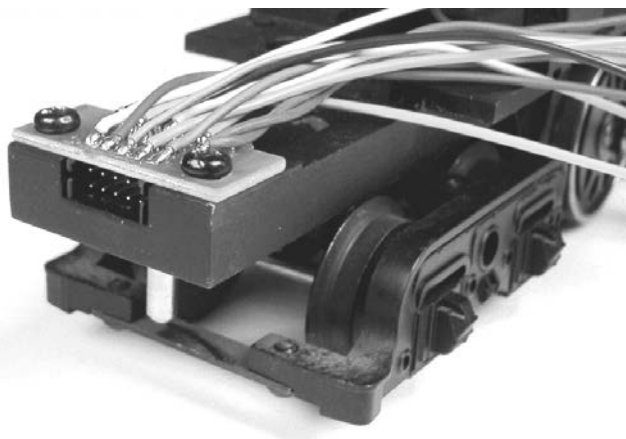

Check the alignment of the 10-pin connector with the plug cut-away at the back of the boiler. Use the spacer (Y) if necessary.

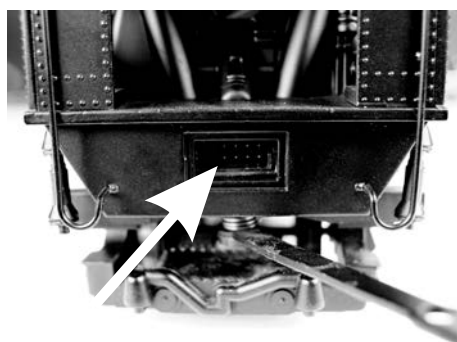

Spacer (Z) will prevent gap from appearing above plug.



If needed, the spacer goes beneath the 10- Pin connector. It may need to be cut to fit.

Connecting Motor, Ground & Pickup Wires

Solder the yellow and white wires to the motor. (Note if the engine starts out in the reverse direction, you will later need to reverse the yellow and white wires to the motor. This will not be tested until installation is complete - see page 30)

Connect the red wire to the pick-up roller using the existing wire nut. You will also need to connect the constant voltage board power lead to this wire as detailed later.

Connect the black wire to chassis ground.

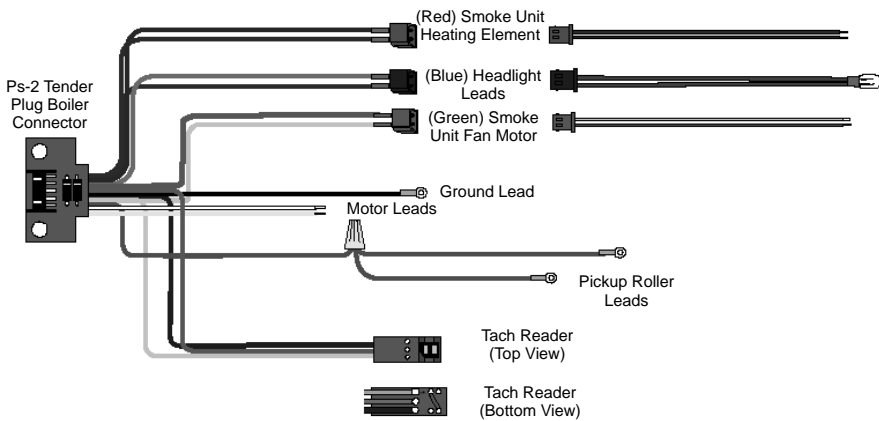

Connecting Headlight Bulb & Wire Harness

Install the Headlight bulb (J) into the proper engine location and connect the headlight bulb wire connector (blue) to the engine harness connector (blue) attached to the sky blue and purple wires.

Installing The Headlight Into RailKing Steam Engines

On RailKing steam locomotives, the headlight is usually a screw based bulb inserted into a bracket mounted to the chassis. This bulb must be replaced and the screw base bracket drilled out with a 3/8" Drill Bit. Insert the headlight bulb grommet (W) into the drilled out hole followed by the headlight bulb (J).



Drill out the bottom of the screw base for the original headlight bulb used in RailKing steam engines.

Once the screw base has been drilled out, insert the rubber headlight grommet (W) into the hole.

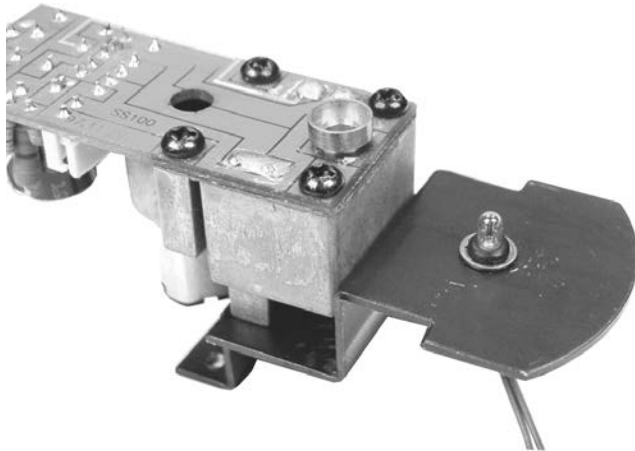

After the rubber grommet has been inserted, push the headlight bulb through the grommet from the bottom of the bracket.

Connecting The Ps-2 Harness To The Smoke Unit

Solder Gray and Green wires to the smoke unit fan motor. If the smoke unit motor terminals are hooked up backward, the impeller will spin in reverse and fail to pump out the smoke. When properly wired, most impellers should rotate clockwise.

Cut through the traces on the top of the smoke unit board. The heating elements **MUST** be isolated from the electronics on the board or the Ps-2 board will be permanently damaged. Another alternative is to cut the printed circuit board such that the electrical components are no longer present since the Ps-2 hardware will be managing the smoke unit heating elements and motor.

Solder the heating pads together at both sides on the top of the board by adding more solder. Then solder the Brown wire to one pad and the Purple to the other (the pads are interchangeable). Soldering to the trace for each end of the element is also acceptable.

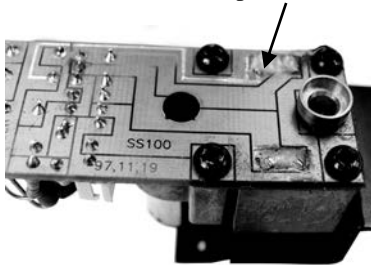

CRITICAL STEP!! Solder together the pads connecting the heating element to the circuit board as shown above. Make sure the heating elements are in parallel. You should measure 8 ohms across the pads. Failure to place the heating elements in parallel will permanently damage the PS-2 board. If your smoke unit does not look like the one shown above see page 22.

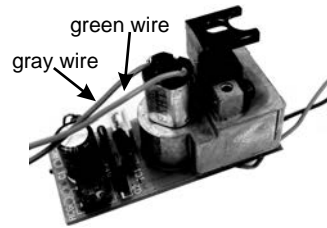

Follow the above wiring directions to the smoke unit motor .

CRITICAL STEP!!

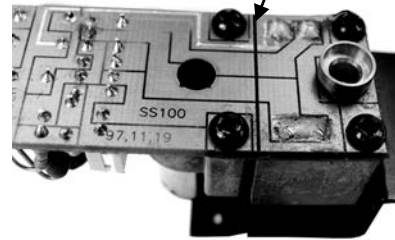

Use a razor saw to cut the bottom of the smoke unit circuit board, isolating the no longer required components on the left. **FAILURE TO CUT TRACE COMPLETELY WILL PERMANENTLY DAMAGE PS-2 BOARD.**

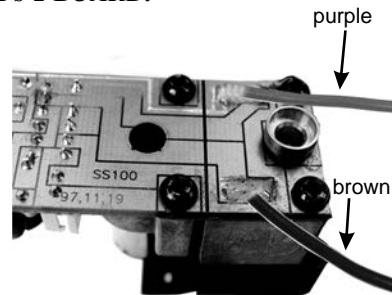

Connect the purple and brown wires to the solder pad locations as seen above.

Other Proto-Smoke Circuit Wiring Methods

Please keep in mind the objective when modifying Original ProtoSound fan driven smoke unit is to place the heating elements in parallel and isolate the heating elements from the smoke unit circuit board components. Please see the picture below showing one other style found in RK Allegheny, Big Boy, and Challengers.

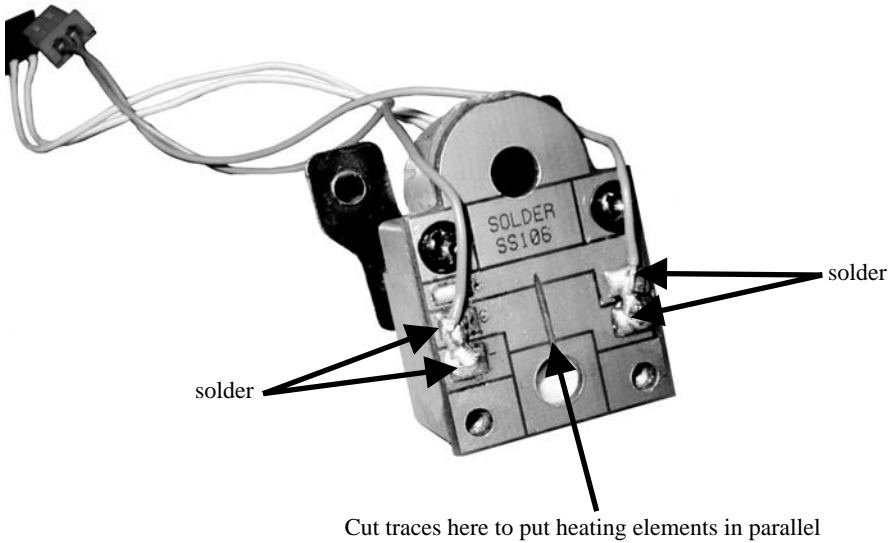

Connect Power To The Constant Voltage Board

Use one of the previous red power wires to provide track power to the locomotive's original constant voltage board (if present). The constant voltage board is used to power all lights in the boiler EXCEPT the headlight.

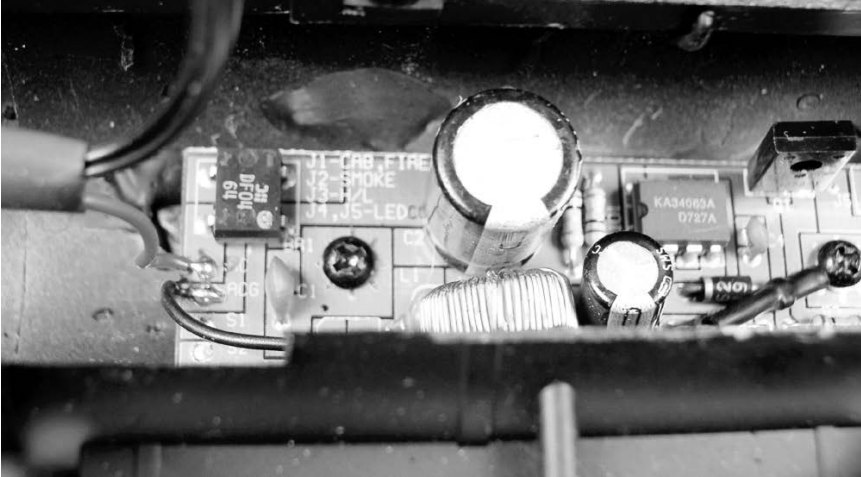

Locate the engine's constant voltage board power pickup wire as shown.

An inductor (V) must be placed "in-line" between the red power wire and the track power wire originally used to power the constant voltage board.



Install the inductor between the engine's power pickup lead and the power lead going to the constant voltage board.



After soldering the inductor into place, use shrink tubing and electrical tape to insulate the inductor completely.

Wire Management/Short Circuit Protection

Route the wires around the motor and chassis such that the wires will not be pinched when the boiler is installed.

NOTE: The wires may need to be cut and spliced together to shorten the length of the wires. Use the shrink tubing (S) supplied in the kit for this purpose whenever necessary.

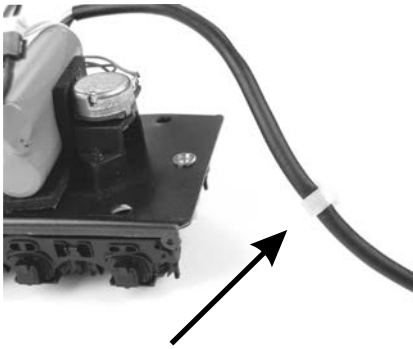
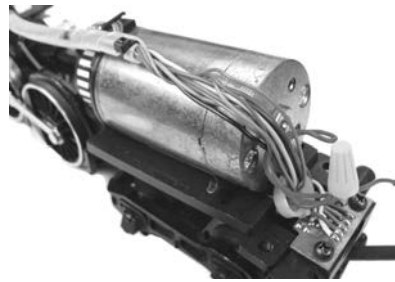
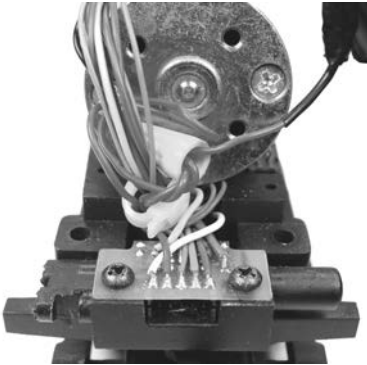

Add 7" wire tie (U) to tender cable to provide "strain" relief. Place the wire tie about 4" from the plug.

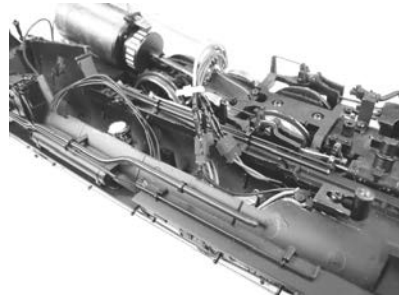

Testing The Ps-2 Upgrade Installation

Connect the tender (without the tender shell on) to the engine (chassis only) by inserting the tender harness into the 10 pin plug at the rear of the engine.

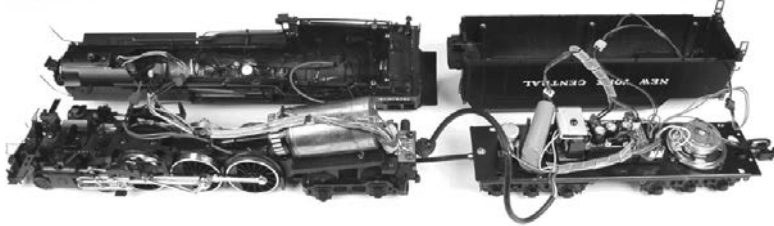

Apply 12 volts of power (in conventional mode) to the engine and tender. If you have a Z4000 look at the current display. The engine should not draw more than 1.5 amps. If the engine draws more than 1.5 amps, shut down power to the engine and tender immediately and check your wiring for any pinched or cut wires. Turn the smoke unit switch off and power up again in conventional mode. The engine without the smoke unit on should not draw more than 1.0 amp. Troubleshoot any problem in the smoke unit or wire harness accordingly.

Check the smoke unit for operation. If no smoke is coming out or you can't feel the fan blowing air out, the gray/green wires connected to the fan motor may be reversed.

Press the direction button and verify the locomotive moves in the forward direction. Reverse the white and yellow motor wires if the engine starts in reverse. If the engine does not move, the battery most likely needs to be charged. (See battery charging instructions on page 43)

Press the whistle button and verify the whistle test sound. The sound is not a normal whistle but a test tone.

Press the bell button and verify the bell test sound. The sound is not a normal bell but a test tone.

Fire the coupler using the combination signal in conventional mode or the digital signal with the DCS remote.

Press the direction button and verify the engine stops.

Press the direction button again and verify the engine moves in reverse direction and that the headlight and back-up lights work properly.

Install the tender and boiler shells on the tender and engine chassis being very careful not to pinch any wires in the process and repeat the tests above.

Loading The Ps-2 Sound File Into The Upgraded Engine

Before your upgraded locomotive will play locomotive sounds, the Ps-2 circuit board needs to be programmed with the appropriate Ps-2 Conversion File for your engine type. Programming can only be accomplished with the M.T.H. DCS Digital Command System and the free DCS Loader Program. Both the Loader Program and the Ps-2 Conversion Files can be found on the Proto-Sound website (www.protosound2.com). Complete instructions for downloading the Loader Program and the Ps-2 Conversion files are found on the website.

Note: It is important to remember that only the Ps-2 Conversion Files can be used to program your Ps-2 Upgrade circuit board. The sound files found on the regular M.T.H. Website will not work in the Ps-2 Upgrade circuit board.

Once you have the DCS equipment and have downloaded the DCS Loader Program, you will need to visit the Ps-2 Upgrade page on the Proto-Sound 2 website and search for your locomotive model or one similar to it in order to find the sound file you will need to download. Each Ps-2 Conversion File has been optimized for its intended locomotive and takes into consideration the type of motor, the gear ratio and most importantly, the size of the drive wheels to govern the speed of the locomotive. Users trying to install a steam switcher locomotive (i.e.: 0-6-0) Ps-2 Conversion File into a large mainline steam engine (ie: 4-8-4 Northern), for example, will find that the locomotive cannot run at the same scale speed as other engines and that the chuff rate will not be properly timed with the driver revolutions. This is because the driver sizes of the two different locomotives are drastically different from one another.

Follow the illustrations on the following pages to learn how to search for the locomotive you are upgrading and download the appropriate sound file. Once the sound file has been downloaded into the engine, it will be necessary to program the engine name using the DCS remote. Follow the DCS instructions for renaming a locomotive.

Note: If you are upgrading a non-M.T.H. Locomotive, pick a model in the search engine similar to the model you are upgrading. It is possible that the scale speeds and chuff rates may be slightly off for the reasons discussed above.

STEP 1:

The Ps2 upgrade kit utilizes the 3volt Ps2 board. To find a 3volt sound file, go to www.mthtrains.com and select “Service”. Then select “Product Files and Documents” from the available options.



First, select “Service”

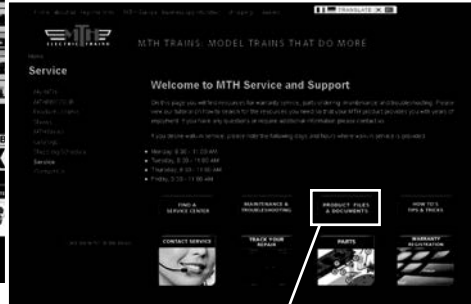

Then, click on “Product Files and Documents”

STEP 2:

Search using the general engine type, such as 4-6-6-4 or Challenger. Engine wheel arrangement is recommended.

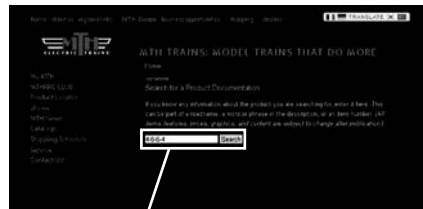

Search for the general engine type

Refine the search by selecting the Product Line, or the Road Name desired. (Note: You may have to use another road name or product line - RailKing vs. Premier - for the upgraded engine.) If you do not find a sound set with the appropriate product line or road name, select the best sound for the locomotive.

Since most Steam models use different wheel diameter and gear ratios, RailKing and Premier sound files can not be used interchangeably without effecting the speed. (Note: Premier engines usually have more lighting options.)



Refine your search results with these options

STEP 3:

Select the engine sound file from the results list.

Remember to select a 3volt production file, or the Ps2 Upgrade Sound File (if available). Right click and save the sound file to your computer. Use the DCS Loader Program to load the sound file into your engine.

Select either the 3volt Production File or PS 2.0 Upgrade sound file, and save the file to your computer

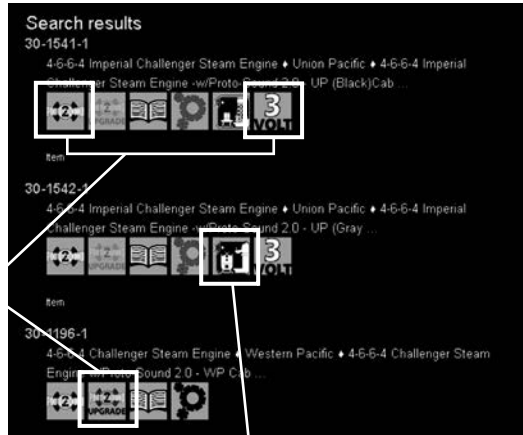

Indicates Freight Yard Sounds



Indicates Passenger Station Sounds

STEP 4:

Name the engine so the name appears on the DCS remote using the Edit Name DCS feature under Engine Setup. Add the engine to the DCS system. The engine will add, but no name will appear next to the engine address number. Use the edit name feature to add the engine name (limit 16 characters).

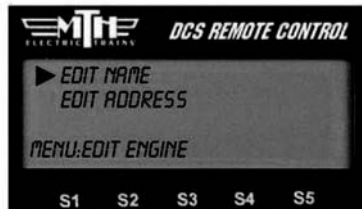

After adding the engine into the DCS system, name the engine on your DCS remote using the Edit Name feature

Conventional PS-2 Operation

The Throttle knob controls how fast your train will travel. Turn the throttle knob up ½-way, until the engine and caboose lights shine bright.

Activating Features

Throttle - To increase or decrease track voltage, and therefore train speed, turn the throttle control knob. Turning clockwise will increase voltage and speed, while turning counterclockwise will decrease voltage and speed. The engine will maintain the speed you set after you release the throttle until you turn it again to change the voltage and speed.

Bell - To sound the bell, in an engine equipped with a bell firmly press and release the Bell button. To turn the bell off, press and release the Bell button again. The bell will continue to ring from the time you turn it on until you press and release the button again to turn it off.

Horn/Whistle - To sound the whistle, firmly press the Horn/Whistle button. The whistle will sound for as long as you continue to depress the button. It will stop when you release the button.

Direction - Your train is programmed to start in neutral. The train will always cycle neutral-forward-neutral-reverse with each press and release of the direction button. The engine is programmed to restart in neutral each time the track voltage is turned off for 25 seconds or more.

Manual Volume Control

To adjust the volume of all sounds made by this engine, turn the manual volume control clockwise to increase the volume and counter-clockwise to decrease the volume.

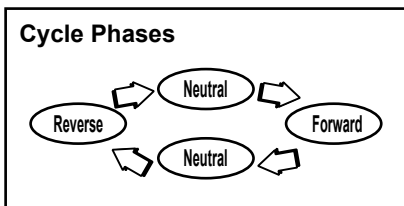

Proto-Sound® 2.0 Operating Instructions

This manual contains the operating instructions for Proto-Sound 2.0 in conventional mode only. Instructions for accessing DCS command mode features accompany the DCS Remote Control System equipment.

Activating Proto-Sound® 2.0 Conventional Mode Features

Proto-Sound® 2.0 features are activated by sequences of Bell and Horn button pushes described below. Please read the full descriptions of each feature before using it. To use these buttons to activate features rather than to blow the horn or ring the bell, you should tap the buttons very quickly with a ½-second pause between button presses. You may need to practice your timing to make this work smoothly.

Timing Chart				
Press Horn Short & Firm	½ Sec. Pause	Press Bell Short & Firm	½ Sec. Pause	Press Bell Short & Firm
Total Time Lapse: 1 ½ Seconds				

Feature to Be Activated	Button Code:
Passenger / Freight Announcements	1 Bell, 2 Horns
Fire the Rear Coupler	1 Bell, 3 Horns
Fire the Front Coupler	1 Bell, 4 Horns
Speed Control On/Off	1 Horn, 2 Bells (from Neutral only)
Lock into a Direction	1 Horn, 3 Bells
Reset to Factory Defaults	1 Horn, 5 Bells (from Neutral only)

Passenger/Freight Announcements (PFA)

Your engine is equipped with a sound package of passenger station or freight announcements that you can play when you pull into a station. Each sequence described below will play as long as it is left on, randomly generating sounds, but be sure to allow approximately 30 seconds between the button pushes described below to allow the PFA sufficient time to run through each sequence.

- To cue the sound system to play the PFA, quickly but firmly tap the Bell button once followed by 2 quick taps of the Horn button while the engine is moving. Tap the buttons quickly but allow approximately ½ second between each press.
- Press the Direction button once to stop the engine. This will trigger the first sequence of PFA. The reverse unit is temporarily disabled so that the train will not move as you use the Direction button to trigger the sounds, and Proto-Sound 2.0 has disabled operator control over the Horn and Bell buttons until the full PFA sequence is complete.
- After waiting about 30 seconds for that sequence to run, press the Direction button again to trigger the second sequence of PFA. After about 30 seconds, press the Direction button again to trigger the third PSA sequence.
- Again, after allowing about 30 seconds for that sequence to run, press the Direction button one more time to trigger the fourth and final PSA sequence. The PSA will continue, and within a few seconds, the engine and bell will start and move out on its own at the current throttle setting, in the same direction it was traveling when you began the sequence. Once the bell turns off, the operator regains control of the transformer's bell and Horn buttons and can ring the bell or blow the Horn as usual.

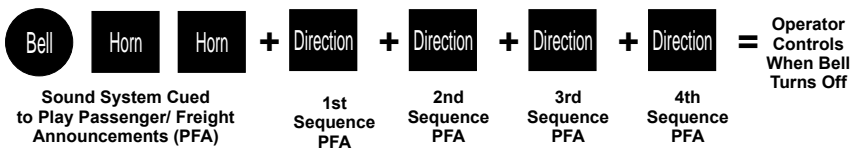

Tips on Using PFA

- You can terminate PFA at any time by turning off power to the track for 15 seconds.
- You do not have to be in Forward to use PFA. At the conclusion of the full sequence, the train will pull away from the station in whatever direction you were going when you activated the feature.
- You can use PFA even if you are double-heading with another engine. If the second engine is not equipped with Proto-Sound 2.0, you must remember not to leave the throttle at a high voltage level once you have stopped the engine to run the PFA. Otherwise, the engine without PFA will begin vibrating on the track as its motors strain to move the train, since they cannot be automatically disabled during the PFA cycle (or if an original Proto-Sound engine, PFA are triggered differently and that engine's motor-disable feature will not be active when you run PFA in Proto-Sound 2.0).
- PFA can be triggered from Neutral. It will operate the same as if triggered while in motion except that, at the conclusion of the PFA, the engine will depart in the next direction of travel, as opposed to the direction it was Traveling before entering Neutral.

Proto-Coupler™ Operation

This locomotive is equipped with one or more coil-wound Proto-Couplers for remote uncoupling action. Because Proto-Couplers are controlled through the Proto-Sound® 2.0 microprocessor, they do not require an uncoupling track section or modification to your layout to function. You can fire a coupler from neutral or while in motion. Use the code shown below (and in the chart on p. 7) to fire the coupler(s).

Rear Coupler:

To fire the rear coupler, quickly tap the Bell button once followed by three quick taps of the Horn button, allowing approximately ½ second to lapse between each quick button press. The sound of the liftbar and air line depletion will play, and the knuckle will be released.



Front Coupler:

To fire the front coupler (if your engine has one), quickly tap the Bell button once followed by four quick taps of the Horn button, allowing approximately 1/2 second to lapse between each quick button press. The sound of the lift bar and air line depletion will play, and the knuckle will be released.



Speed Control

M.T.H. engines equipped with Proto-Sound 2.0 have speed control capabilities that allow the engine to maintain a constant speed up and down grades and around curves, much like an automobile cruise control. You can add or drop cars on the run, and the engine will maintain the speed you set.

While the engine is programmed to start with the speed control feature activated, you can opt to turn it off. This means the engine's speed will fall as it labors up a hill and increase as it travels downward. It is also affected by the addition or releasing of cars while on the run. Because the engine will run more slowly at a given throttle voltage when speed control is on than when it is off, you should adjust the throttle to a lower power level for operation with speed control off to avoid high-speed derailments. When speed control is off, the volume will drop to allow for better low voltage operation.

To turn speed control on and off, put the engine in neutral, then quickly tap the transformer's Horn button one time then quickly tap the Bell button two times, allowing approximately 1/2 second to lapse between each quick button press. Two horn blasts will indicate that the engine has made the change. Repeat the 1 horn, 2 bells code to return it to the other condition. You will want to do this during the initial neutral upon start-up if you ever couple this engine to another engine that is not equipped with speed control to avoid damaging the motors in either engine. Each time you shut down the engine completely, it will automatically turn speed control on.



Locking Locomotive Into a Direction

You can lock your engine into a direction (forward, neutral, or reverse) so that it will not change directions. To do this, put the engine into the direction you want (or into neutral to lock it into neutral), run it at a very slow crawl (as slowly as it will move without halting), and quickly but firmly tap the Horn button once followed by three quick taps of the Bell button, allowing approximately ½ second to lapse between each quick button press. Two horn blasts will indicate that the engine has made the change. The engine will not change direction (including going into neutral) until you repeat the 1 horn, 3 bells code to return the engine to its normal condition, even if the engine is kept without power for extended periods of time.



Reset To Factory Default

To override the settings you currently have assigned to the engine and reset it to its factory defaults, while in Neutral tap the Horn button quickly once, followed by five quick taps of the Bell button, allowing approximately ½ second to lapse between each quick button press. Two horn blasts will indicate that the engine has made the change.



Automatic Sound Effects

Certain Proto-Sound 2.0 sound effects automatically play in programmed conventional mode conditions:

- Squealing Brakes play any time the engine's speed decreases rapidly.
- Cab Chatter plays at random intervals when the engine idles in neutral.
- Engine Start-up and Shut-down sounds play when the engine is initially powered on or is powered off for five seconds or more.

Self Charging Battery Back-up

The special rechargeable 2.4v self-charging battery recharges continuously during train operation and should last for up to five years. The battery is a dry battery that should not leak or cause any damage to your engine. Depending upon when your engine was built, it may need to be charged right out of the box. If engine sounds seem distorted or garbled at low voltages or become silent when power from the transformer is turned off, test the battery to determine whether it should be recharged or replaced.

Test: Put the engine in neutral and leave the track voltage at 10-12 volts (high enough for the lights to shine brightly) for 15 minutes.

Recharge: If the sounds are improved at the end of the 15-minute test charge, the battery charge has run down and can be recharged. There are a number of ways you can do this:

- Leave the engine in neutral with track voltage at 10-12 volts for 6-7 hours so the battery can fully recharge (if your engine has a smoke unit, be sure it is turned off).
- Use M.T.H.'s battery recharger (Item No. 50-1019) (sold separately) that plugs into a wall outlet and a special port under the engine to recharge the battery overnight without leaving it on the track.

Replace: If the sounds are not improved at the end of the 15-minute test charge, it is time to replace the battery. Available through M.T.H. Parts:

(Part No. BG-4000003) AA Proto-Sound® Battery

(Part No. BG-4000004) AAA NiMH Proto-Sound® Battery

DO NOT substitute alkaline batteries for these rechargeable batteries. Using alkaline batteries in this system can result in damage to the PS 2.0 circuit board and/or the batteries.

Do not use alkaline batteries for testing or checking purposes for the 3-Volt PS2 boards. Using alkaline batteries will damage the 3-Volt battery charging circuit.

Troubleshooting Proto-Sound® 2.0 Problems

Although Proto-Sound 2.0 has been designed and engineered for ease of use, you may have some questions during initial operation. The following table should answer most questions. If your problem cannot be resolved with this table, contact M.T.H. for assistance (www.mth-railking.com, e-mail: parts@mth-railking.com, Fax: 410-423-0009, Phone: 410-381-2580, Mail: 7020 Columbia Gateway Drive, Columbia MD 21046-1532,).

Starting Up	Remedy
When I first turn the power on, the engine will not begin to run. I have to turn the throttle off and then on again to get the engine to operate.	This is normal behavior. To prevent accidental high-speed start-ups, Proto-Sound 2.0 is programmed to start up in neutral anytime track power has been turned off for several seconds. See the "Basic Operation" section for more details.
Whistle/Horn	Remedy
When I press the whistle/horn button, the bell comes on instead.	Reverse the transformer leads.
I can't get the horn to blow when I press the whistle button.	You may be pressing the button too quickly. Try pressing the whistle/horn button more slowly, taking approximately one full second to fully depress the button.
Bell	Remedy
When I press the whistle button, the bell sounds.	Reverse the transformer leads.
I can't get the bell to ring when I press the bell button.	You may be pressing the button too quickly. Try pressing the bell button more slowly, taking approximately one full second to fully depress the button.
The bell won't work on a separate bell button.	Check the wiring of the separate button.
Coupler	Remedy
When I try to fire the coupler, PFA starts.	You are waiting too long between whistle button presses.
The Proto-Coupler won't let the engine uncouple on the fly.	Try lubricating the coupler knuckle with a dry graphite lubricant. Do NOT use oil.
The coupler does not fire or stay coupled.	The coupler needs to be cleaned. Wipe with denatured alcohol (not rubbing alcohol) and let dry.

Cab Chatter	Remedy
Sometimes the Cab Chatter sounds don't play.	Cab Chatter plays only in neutral at random intervals.
Lock-out	Remedy
I can't get the engine to run after I power up the transformer. It sits still with the engine sounds running.	The engine is locked into the neutral position. Follow the procedure in the "Lock into a Direction" section.
The engine won't lock into forward, neutral, or reverse.	Engine speed must be below 10 scale mph (approx. 10 volts or less in conventional mode).
Volume	Remedy
The sounds seem distorted, especially when the whistle or bell is activated.	Proto-Sound 2.0 volume is set too high. Turn the volume control knob on the bottom of the chassis counter-clockwise to reduce the volume.
Battery	Remedy
The engine will not leave the initial neutral setting.	Check to be sure the battery is installed and fully charged. See the "Self-Charging Battery Back-Up" section.
I get no sounds when the engine shifts between directions.	The battery may be dead or need to be charged. See the "Self-Charging Battery Back-Up" section.
After I turn off my transformer, my engine continues to make sounds before quitting.	Proto-Sound 2.0 is designed to continue to sound for a few seconds after power to the track has been shut off.
PFA	Remedy
The PFA sounds occasionally repeat themselves.	Proto-Sound 2.0 has a built-in random number generator that randomly selects each sound clip to play. Because there are a limited number of sound clips available in each PFA sequence, it is probable that some of these sound clips will be repeated from time to time.

PFA	Remedy
Once in PFA, the engine doesn't go into reverse.	So that PFA effects can be as realistic as possible, Proto-Sound 2.0 disables the reversing unit whenever PFA is enabled. This way the engine remains still at its stop as the operator cycles through the PFA sequences.
When the PFA enters its last sequence the bell automatically comes on.	PFA is programmed to start ringing the bell at that point. After approximately 12 rings of the bell, it will automatically turn off.
When PFA is enabled, pressing the whistle and bell buttons has no effect.	Because FYS must control various effects in each sequence, Proto-Sound 2.0 takes control of these sound effects until you exit FYS.
I push the direction button but the next sound clip in the sequence does not play or the engine does not come out of PFA after fourth press of the direction button.	Each PFA clip must play for approx. 30 seconds before PFA will advance to the next step in the PFA cycle. Wait at least 30 seconds in each PFA sound clip before pressing the direction button.

Service & Warranty Information

How to Get Service Under the Terms of the Limited Warranty

When you suspect an item is defective, please check the operator's manual for standard operation and trouble-shooting techniques that may correct the problem. Additional information may be found on the M.T.H. Website. Should you still require service, follow the instructions below to obtain warranty service.

First, e-mail, write, call or fax the M.T.H. Authorized Proto-Sound 2.0 Conversion Center that installed the kit to obtain Repair Authorization. You can find the list of conversion centers on the M.T.H. Website, www.mth-railking.com. The center that installed the kit will provide service during the warranty period. Should the warranty no longer apply, you may choose either an ASC or NASC retailer to service your M.T.H. Product. A reasonable service fee will be charged.

CAUTION: Make sure the product is packed in its original factory packaging including its foam and plastic wrapping material to prevent damage to the merchandise. There is no need to return the entire set if only one of the components is in need of repair unless otherwise instructed by the Service Center. ***The shipment must be prepaid and we recommend that it be insured. A cover letter including your name, address, daytime phone number, e-mail address (if available), Return Authorization number (if required by the service center, a copy of your sales receipt and a full description of the problem must be included to facilitate the repairs. Please include the description regardless of whether you discussed the problem with a service technician when contacting the Service Center for your Return Authorization.***

Please make sure you have followed the instructions carefully before returning any merchandise for service. Authorized M.T.H. Service Centers are independently owned and operated and are not agents or representatives of M.T.H. Electric Trains. M.T.H. assumes no responsibility, financial or otherwise, for material left in their possession, or work done, by privately owned M.T.H. Authorized Service Centers.

If you installed the PS-2 Upgrade Kit yourself, there is no warranty. Contact M.T.H. for replacement parts. Any required parts, plus shipping and handling fees will be charged. If you need assistance at any time email MTH Service at service@mth-railking.com, or call 410-381-2580.

Limited 90-Day Warranty

This product, when installed by an Authorized M.T.H. Proto-Sound 2.0 Conversion Center, is covered by this warranty. See our website at www.protosound2.com or call 410-381-2580 to identify an Authorized M.T.H. Proto-Sound 2.0 Conversion Center near you.

M.T.H. Proto-Sound 2.0 Upgrade Kits are warranted for 90 Days from the date of installation by an Authorized M.T.H. Proto-sound 2.0 Conversion Center against defects in material or workmanship. We will repair or replace (at our option) the defective part without charge for the parts or labor, if the item is returned to the M.T.H. Authorized Proto-Sound 2.0 Conversion Center who installed the kit within 90 Days of the installation. This warranty does not cover damages caused by improper care, handling, or use. Transportation costs incurred by the customer are not covered under this warranty. This warranty does not cover any installation charges incurred from installing the conversion kit.

Items sent for repair must be accompanied by a return authorization number, a description of the problem, and a copy of the original sales receipt from an Authorized M.T.H. Proto-Sound 2.0 Conversion Center, which gives the date of purchase and installation of the kit. If you are sending this product to an Authorized Proto-Sound 2.0 Conversion Center, contact that Center for their return authorization. This warranty gives you specific legal rights, and you may have other rights that vary from state to state. Specific questions regarding the warranty may be forwarded to M.T.H. directly.

Service Department
M.T.H. Electric Trains
7020 Columbia Gateway Drive
Columbia MD 21046-1532